

Historic, archived document

Do not assume content reflects current scientific knowledge, policies, or practices.

THOMAS J. GREY
COMPANY

THE SEEDSMEN

SEEDS·BULBS
AND PLANTS
AGRICULTURAL
IMPLEMENTS

1933

16 SOUTH MARKET STREET
BOSTON·MASS.

JAN 17 1933

Important To Customers

ORDER EARLY.—We would suggest that customers send us their orders as soon as possible after receiving this catalogue, and thus avoid the rush of the planting season. It frequently happens that some articles are not in stock when orders are received. In such cases we forward such as are ready, and the balance as soon as possible.

STOCK SEED.—A large part of our seeds are grown for us on contract by special growers, from our own stock, and in locations best suited for their development. Others are secured from strictly reliable sources, and constant effort is made to secure only the best.

ADDRESS, ETC.—Give name of your post office, county and state, sign your name plainly; also specify means of conveyance preferred—whether by parcel post, express or freight.

FREE DELIVERY.—We will send by parcel post, to any part of the United States, all Vegetable and Flower Seeds quoted in this catalogue at packet, ounce, quarter-pound and half-pound rates, free of expense to the purchaser. All heavy seeds, including Peas, Beans, Corn, Clover Seed, Seed Grain, Roots, etc., are quoted at net prices at our store. Purchasers desiring these by mail are requested to remit an additional amount sufficient to cover postage, at parcel post rates according to zone. Allow two pounds in weight for each quart of Peas, Beans, or Corn. Particular attention is invited to this, as, when omitted, the cost of postage will be deducted from the amount received.

SHIPPING.—We deliver free to Express, Railroad or Boat. All goods travel at the buyer's risk, our responsibility ceases when we take the carrier's receipt. If goods are damaged so sign for them and enter claim with the carrier at once.

BAGS AND PACKING.—No charge is made for boxes or packing on anything, except Flower Pots, Nursery Stock and Hotbed Sash, and this at cost only. Cloth Bags are charged for at cost and if returned in good condition, charges prepaid, will be credited at price charged.

REMITTANCES.—May be made by Express Money Order, P. O. Money Order or Bank Draft; if stamps or cash send in a Registered Letter. Parties having no account with us—who order goods without remittance—must furnish satisfactory references. Boston preferred.

PRICES. All prices are net without discount and subject to change without notice.

TERMS ARE NET CASH.—All bills on which short credits are allowed are due on the first of the month succeeding the date of the purchase.

WE MAKE A SPECIAL EFFORT to carry a full stock of Seeds, Tools, Implements and repairs for the wants of the retail trade.

GARDENERS' AND FARMERS' SITUATIONS.—We have at all times the names of practical gardeners and farm managers in want of situations on our books. If parties desiring such will write us, we shall be glad to put them in communication with men whom we deem suitable. To aid us in making a selection we ask full particulars. We make no charge for this service.

We give no warranty, expressed or implied, as to quality, description, productiveness, or any other matter of any Seeds, Bulbs or Plants we send out, and will not be in any way responsible for the crop. If the purchaser does not accept the goods on these terms, they must at once be returned.

PARCEL POST RATES

Packages must not exceed 100 inches in length and girth combined. Seventy pounds is the limit of weight.

Wght. in Lbs.	ZONES							
	Local	1st and 2d	3d	4th	5th	6th	7th	8th
		Up to 150 miles	150 to 300 miles	300 to 600 miles	600 to 1000 miles	1000 to 1400 miles	1400 to 1800 miles	Over 1800 miles
1. . . .	\$0.07	\$0.08	\$0.09	\$0.10	\$0.11	\$0.12	\$0.14	\$0.15
2.08	.10	.11	.14	.17	.19	.23	.26
3.08	.11	.13	.17	.22	.26	.32	.37
4.09	.12	.15	.21	.27	.33	.41	.48
5.09	.13	.17	.24	.33	.40	.50	.59
6.10	.14	.19	.28	.38	.47	.59	.70
7.10	.15	.21	.31	.43	.54	.68	.81
8.11	.16	.23	.35	.49	.61	.77	.92
9.11	.17	.25	.38	.54	.68	.86	1.03
10.12	.18	.27	.42	.59	.75	.95	1.14
11.12	.19	.29	.45	.64	.82	1.04	1.25
12.13	.21	.31	.49	.70	.89	1.13	1.36

Postage on seeds, bulbs, plants and roots of 8 ounces or less to all zones, is 1c. for each 2 ounces.

Postage on general merchandise of 8 ounces or less, to all zones, is 1½c. for each 2 ounces.

THOMAS J. GREY COMPANY

THE SEEDSMEN

16 SOUTH MARKET STREET

BOSTON, MASS.

TELEPHONE: CAPITOL 7476-7477

ROBERT E. MONTGOMERY, President

JOHN P. A. GUERINEAU, Treasurer

FRANCIS R. CONBOY, Secretary

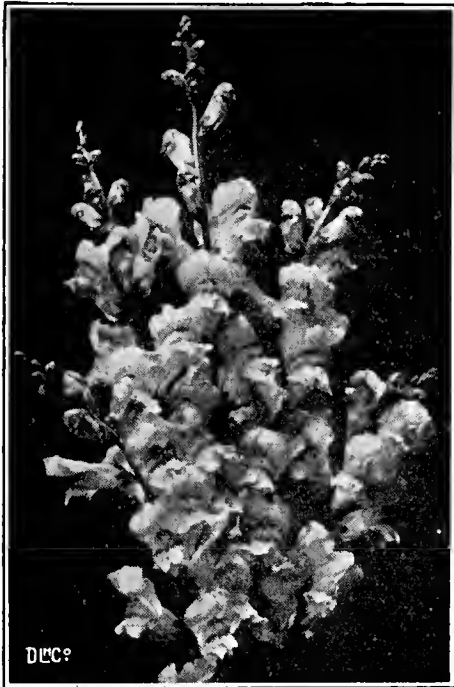

Antirrhinum

Flower Seed Novelties and Specialties for 1933

See pages 29 to 62 for General List
of Flower Seeds

See page iv for seeds of Rock
Garden Plants

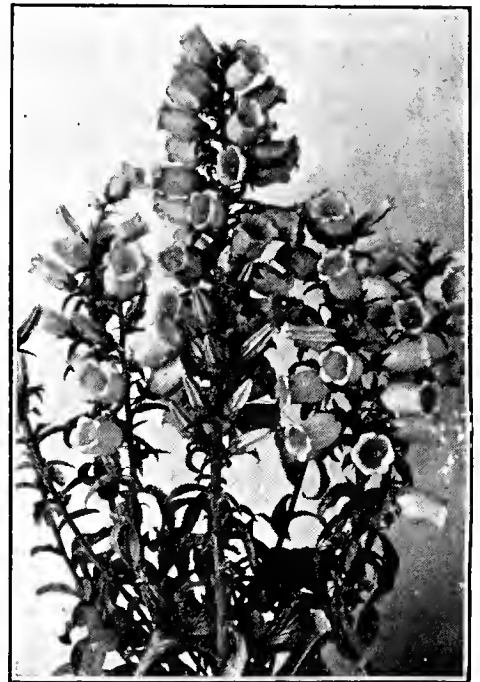

Canterbury Bells

ANTIRRHINUM, or Snapdragon FOR GREENHOUSE

- CINCINNATI**, light pink; **SUNSHINE**, deep yellow;
TERRY'S SURPRISE, pink and bronze. Pkt. ea. \$2.00.
AFTERGLOW, bronze; **CHEVIOT MAID SUPREME**,
dark pink; **CLAUDESPY**, white; **DAWN**, Talisman Rose
color; **HAPPINESS**, pure pink; **ROSE QUEEN**; **WIN-
TER HELEN**, salmon. Pkt. each \$1.50.
CEYLON COURT, yellow; **GARNET**; **GOLDEN PINK
QUEEN**; **INDIAN SUMMER**, copper color; **JENNIE
SCHNEIDER**, rose; **JUDD'S DARK PINK**; **ROMAN
GOLD**; **WHITE ROCK**. Pkt. each \$1.00.

NANUM GRANDIFLORUM

- 366 **MAJESTIC "ELDORADO."** Self color, large, deep
golden yellow flowers on dense spikes. Pkt. 25c.
368 **MAJESTIC "ORANGE KING."** Pkt. 25c.
369 **MAJESTIC "RED CHIEF."** Color rich deep scarlet.
Pkt. 25c.
370 **MAJESTIC "ROSE MARIE."** Large light salmon
rose with golden center on dense spikes. Pkt. 25c.
372 **MAJESTIC "TWILIGHT."** Rosy salmon. Pkt. 25c.

BEGONIA TUBEROUS-ROOTED

- BLACKMORE & LANGDON'S
SPECIAL STRAIN.** Original
packets. Pkt.
1142 **Double Finest Mixed** \$1.00
1147 **Single Finest Mixed**. 1.00
1152 **Extra Frilled Finest
Single Mixed**..... 1.00
1154 **BASKET BEGONIAS.**
Selected strain..... 1.00

SEMPERFLORENS

- 1208 **GUSTAVE KNAAKE.**
Glowing salmony pink, leaves
green. Excellent for pot culture,
Pkt. 35c.

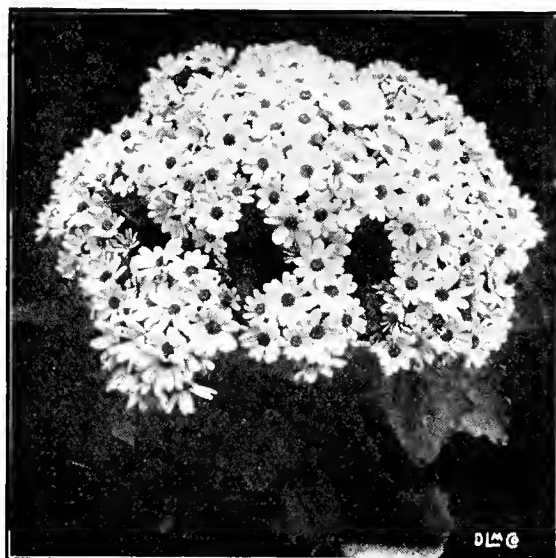

Cineraria

ASTER

714 **INDIAN SUMMER** (New). Crego type, flowers 4½
to 5 in. diameter, color cinnabar, very double petals
curled and twisted. Pkt. 25c.

CANTERBURY BELLS

1458 **NEW ANNUAL.** Seed sown in February blooms in
July. Height 2 to 2½ ft., 6 to 8 spikes of bloom. Mixed
only, containing dark blue, light blue, pink, rose and
white. Pkt. 25c.

CINERARIA

MULTIFLORA GRANDIFLORA MAXIMA. A hybrid
between "Multiflora nana" and "Grandiflora" having
large blooms of the grandiflora and many flowers of
multiflora nana. 12 to 16 in. above the pot. Pkt.

- 1876 **Light Rose**.....\$1.00
1877 **Salmon Rose**..... 1.00
1878 **Carmine**..... 1.00
1879 **Dark Red**..... 1.00

- 1881 **Cornflower Blue**..... 1.00
1882 **Marine Blue**..... 1.00
1883 **White**..... 1.00
1884 **Mixed**..... 1.00

MULTIFLORA NANA. A new
Cineraria created by a Swiss flor-
ist. Makes a beautiful pot plant.
Very compact growth, 10 in.
above the pot. Leaves rather
smaller than the grandiflora
type of Cineraria. Flowers slight-
ly more than 1 in. in diameter
with centers varying from yellow
to brown. Pkt.

- 1911 **Dark Blue**.....\$0.75
1912 **Deep Red**..... .75
1913 **Lavender**..... .75
1914 **Light Blue**..... .75
1915 **Pure White**..... .75
1916 **Pink**..... .75
1917 **Rose**..... .75
1918 **Mixed**..... .75

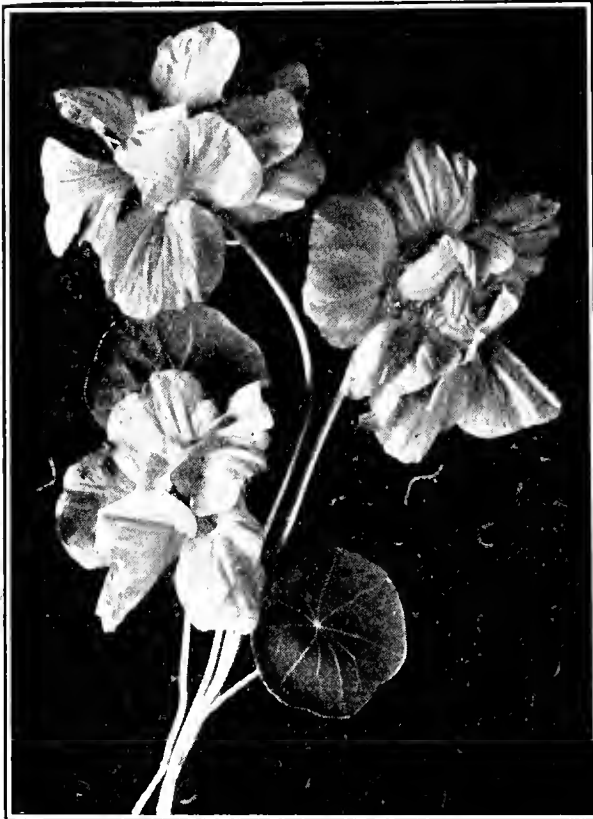

Double Nasturtium Golden Gleam

NASTURTIUM (Double)

- 5812 **BODGER'S SWEET-SCENTED GOLDEN GLEAM.** "A double variety from seed." Flowers rich golden yellow. Vines semi trailing, about 2 ft. Fine for open garden or window boxes. $\frac{1}{4}$ oz. 40c., pkt. 25c.

PANSY

ROGLI, or SWISS GIANTS

- 6162 **ALPENGLOW.** Rich deep red shades. Pkt. 50c.
 6241 **SWISS GOLDEN YELLOW.** Pkt. 50c.
 6242 **ULLSWATER BLUE (Lake of Thun).** The deepest of all blue Pansies; very large. Pkt. 50c.

PRIMULA MALACOIDES ERICKSONI

(Originator's Seed)

- 6946 **BABY ROSE.** Very deep pink. Pkt. \$1.50.
 6956 **NEW BABY.** Lavender pink. Pkt. \$1.50.
 6966 **WONDER BABY.** Beautiful pink. Pkt. \$1.50.

DAHLIA

- 2199 **COLTNESS MIGNON.** Very dwarf. Extra fine bedder. Mixed. Pkt. 25c.

GAILLARDIA GRANDIFLORA

- 2783 **BURGUNDY.** Shining wine red flowers, $2\frac{1}{2}$ in. across. Plants bushy, $2\frac{1}{2}$ ft. high. Pkt. 25c.

MARIGOLD (African)

- 5456 **ALL DOUBLE LEMON.** Large flowers, very tall growing plants. Pkt. 25c.
 5458 **ALL DOUBLE ORANGE.** Pkt. 25c.
 5492 **GUINEA GOLD.** A distinct type, rich color; flowers loosely double; a fine cut flower variety. Pkt. 25c.



Verbena Dwarf Fireball

NEW GIANT SPENCER VARIETIES OF SWEET PEAS

(See also pages 58 and 59 for standard sorts, and page 59 for Winter-flowering sorts)

- 7476 **BON BON.** Rich pink shading amber. Pkt. 25c.
 7498 **CATTLEYA QUEEN.** Rose mauve tinted orchid. Pkt. 25c.
 7688 **PIRATE GOLD.** Golden orange. Pkt. 25c.
 7698 **ROSIE.** Deep rose pink. Pkt. 25c.

NEW EARLY SPENCER SWEET PEAS

- 7811 **BALL BLUE.** Clear blue. Pkt. 25c.
 7812A **BALL ROSE.** Sparkling rose pink. Pkt. 25c.
 7834 **FRAGRANCE.** Clear lavender, self color. Pkt. 25c.
 7838 **GLORIA.** Salmon rose. Pkt. 25c.
 7854 **MISS ANNIE LAURIE.** Rose pink, long stems. Pkt. 25c.
 7874 **ROSEMARIE.** Cream tints merging rose. Pkt. 25c.

VERBENA

- 8186 **DWARF FIREBALL.** Literally covered with bright scarlet blooms, grows about 6 in. high, Comes true from seed. Pkt. 25c., $\frac{1}{8}$ oz. 60c.
 8188 **LAVENDER [GLORY GRANDIFLORA.]** True lavender with creamy white eye; fragrant. Pkt. 25c.

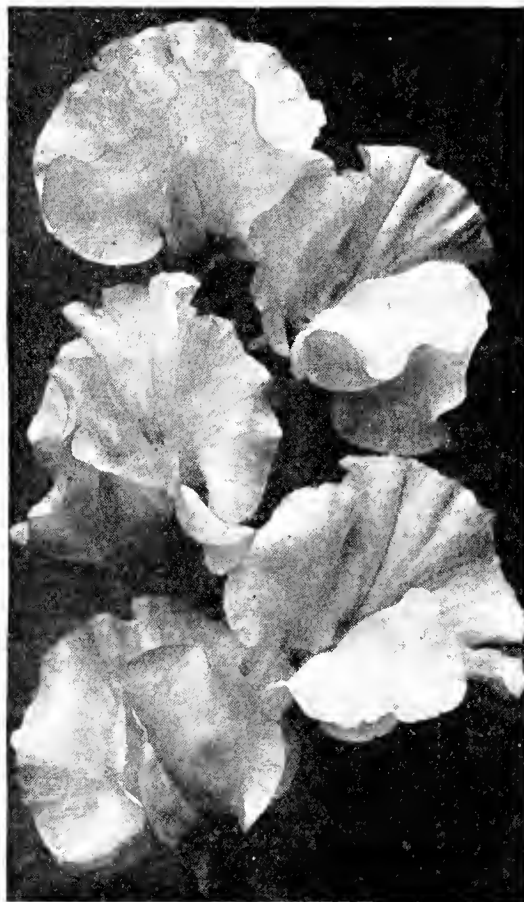

Giant Spencer Sweet Peas

WE ARE HEADQUARTERS FOR THE FINEST LAWN GRASSES, FERTILIZERS, SPRAYING MATERIAL, INTERNATIONAL HARVESTER COMPANY'S LINE OF IMPLEMENTS, PLOWS, Etc.

FLOWER SEED NOVELTIES AND SPECIALTIES FOR 1933—Continued

ZINNIA

CALIFORNIA GIANTS

This is a change from the Dahlia-flowered type and it carries the same robust habit of growth. The flowers are very graceful, of large size and flat, with a small, flat center. Height 3 to 4 ft.

	Pkt.
8600 CERISE QUEEN. Beautiful cerise rose.....	\$0.25
8605 DAFFODIL. Canary yellow.....	.25
8610 ENCHANTRESS. Light rose, deeper rose center.....	.25
8615 GOLDEN QUEEN. Golden lemon.....	.25
8620 GRENADIER. Bright dark red.....	.25
8625 LAVENDER GEM. Deep lavender.....	.25
8630 MISS WILLMOTT. Soft pink.....	.25
8635 ORANGE QUEEN. Golden orange.....	.25
8640 PURITY. White.....	.25
8645 SALMON QUEEN. Salmon rose.....	.25
8650 MIXED COLORS25
8660 COLLECTION OF 10 SEPARATE VARIETIES	2.00

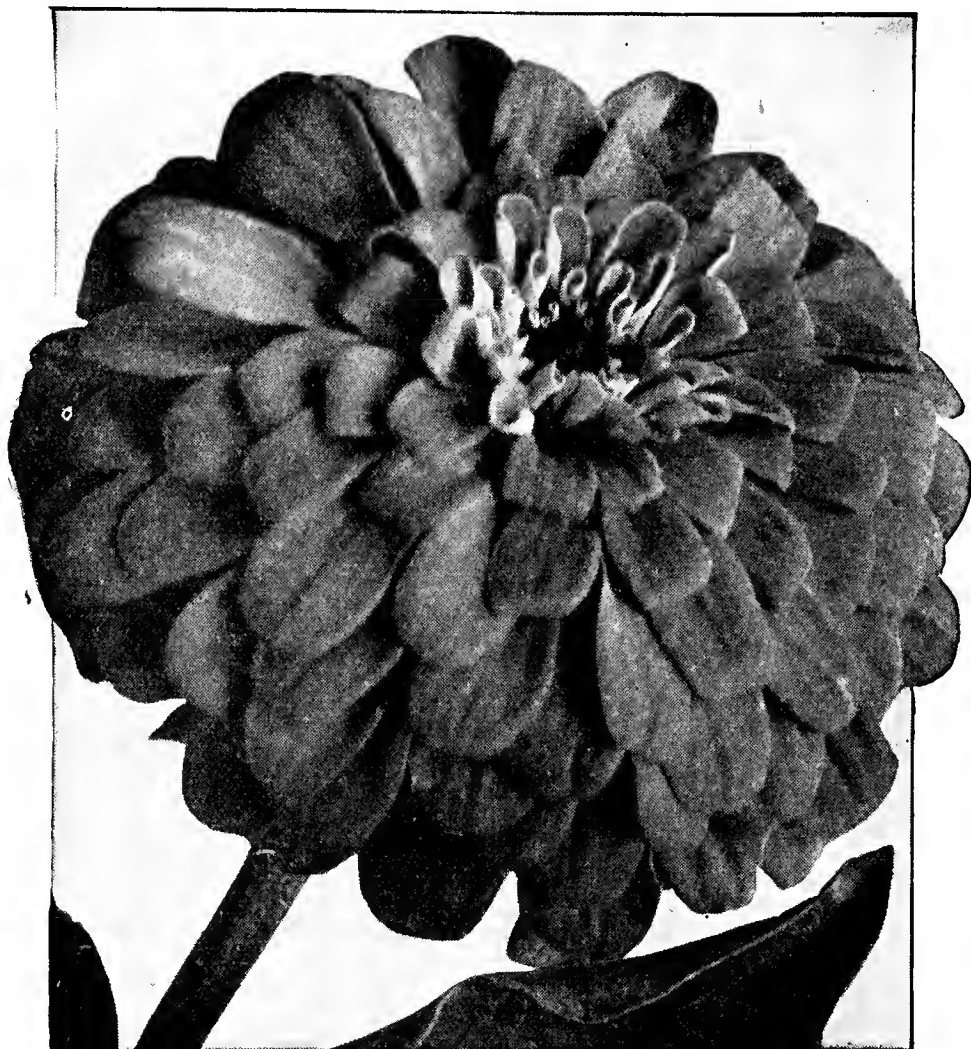

Zinnia, California Giant

ZINNIA EARLY WONDER

8498 **EARLY WONDER.** A new race of dwarf early flowering Zinnias, growing 12 to 15 in. high. Color, fiery salmon cerise pink flowers borne on medium size long stems that start from the ground with no laterals and very few leaves. In the greenhouse it produces flowers in 45 days from seed. 1/8 oz. 60c., pkt. 20c.

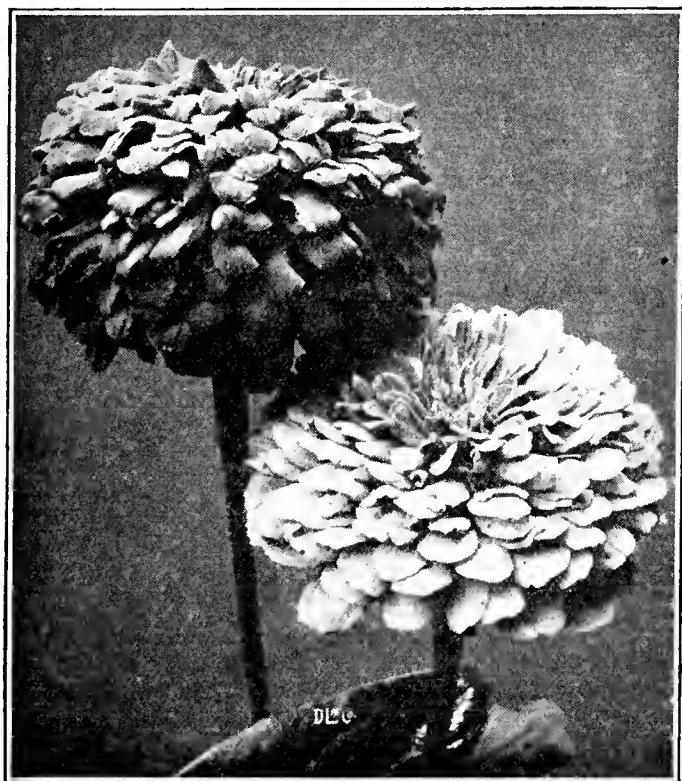

Zinnia, Giant Dahlia-flowered

ZINNIA

GIANT DAHLIA-FLOWERED

	1/8 oz.	Pkt.
8380B CANARY BIRD. Delicate primrose.....	\$0.35	\$0.15
8381 CRIMSON MONARCH35	.15
8382 DREAM. Deep lavender.....	.35	.15
8382A ELDORADO. Rose on deep salmon.....	.35	.15
8383 EXQUISITE. Light rose deep center.....	.35	.15
8383A GOLDEN DAWN. Beautiful golden yellow.....	.35	.15
8384 GOLDEN STATE. Orange yellow.....	.35	.15
8384A ILLUMINATION. Deep rose self color.....	.35	.15
8384B LEMON BEAUTY. Golden yellow or brown, a real pastel shade.....	.35	.15
8384C LUMINOSA. Bright deep pink, light suffusion of salmon.....	.35	.15
8385 METEOR. Glowing deep red.....	.35	.15
8385A OLD ROSE. A real old rose color.....	.35	.15
8385B OLD GOLD. Burnished deep and lighter shades of old gold.....	.35	.15
8386 ORIOLE. Orange and gold.....	.35	.15
8387 POLAR BEAR. Pure white.....	.35	.15
8387A PURPLE PRINCE. A deep purple.....	.35	.15
8388 SPECIAL MIXTURE35	.15

ZINNIA PUMILA PICOTEE

8527 **DELIGHT.** A dwarf double type in shades of salmon, yellow and lavender, flowers not so large and stems more slender than the ordinary type; extra fine for cut flowers. 1/8 oz. 60c., pkt. 25c.

FLOWER SEED NOVELTIES AND SPECIALTIES FOR 1933—Continued



Veronica rupestris



Anemone pulsatilla (Pasque flower)



Oenothera missouriensis (Evening-primrose)

Seeds of Hardy Rock Garden Plants

- 102 **AETHIONEMA** (Persian Candytuft). 9 in. June-July. Sun. Strong, twiggy bushes covered with long, slender spikes of rosy pink flowers. Pkt. 30c.
- 202 **ALYSSUM serpyllifolium** (Alpestre). Very dwarf. 4-5 in. Racemes of pale yellow flowers and rough, hoary leaves. Blooms just after the well known Saxatile variety. Pkt. 20c.
- 248 **ANCHUSA myosotidiflora**. 1 ft. May. Shade. A Russian variety with clusters of blue flowers resembling Forget-me-nots. Very effective. Pkt. 25c.
- 252 **ANEMONE pulsatilla** (Pasque flower). 10 in. April-May. An interesting plant producing violet or purple flowers. Pkt. 25c.
- 1068 **AUBRIETIA eyri**. A dainty low creeping plant. Fine for crevices of rocks. Rosy lilac, flowers for a long period. Pkt. 30c.
- 1292 **CALANDRINIA umbellata**. 4-5 in. Will do well in a hot location where other plants may not succeed. Bright crimson saucer-shaped flowers. Prostrate habit. Pkt. 20c.
- 1392 **CAMPANULA garganica**. June. A low spreading tuft covered with starry light blue flowers with small white eye. Fine for hanging over a rock. Pkt. 35c.
- 1402 **CAMPANULA muralis**. June. Very dwarf plant, fine for wall or rock garden. Covered with blue purple flowers. About the best rock garden plant in the Campanula group. Pkt. 30c.
- 1435 **CAMPANULA rotundifolia** (Scotch Bluebells). 1 ft. June to Aug. Clear blue flowers, especially adapted for crevices. Also does well on steep slopes. Pkt. 25c.
- 2510 **DIANTHUS allwoodi alpinus**. 6 in. June-July. Glossy foliage with large bright rose flowers. Thrives best in loam to which a little lime has been added. Shade a little in hottest part of Summer. Pkt. 50c.
- 2648 **ERIGERON alpinus**. Distinctly a rock garden plant. Dwarf, free flowering clusters of small daisylike flowers of purplish color. Pkt. 25c.
- 2658 **ERINUS alpinus roseus**. 4 in. May-June. The foliage grows in rosettes, the flowers in racemes of rosy purple. Fine for pockets or between steps. Pkt. 25c.
- 6012 **NEPETA mussini** (Ground Ivy). 1-1½ ft. Fine for any place in the rock garden; compact habit, producing masses of lavender flowers. Pkt. 25c.
- 6072 **OENOTHERA missouriensis** (Evening-primrose). 10 in. June to Aug. A low, prostrate growing variety with ascending branches. Flowers very large, soft yellow. Pkt. 30c.
- 7152 **SAXIFRAGA umbrosa** (London Pride). Sun or shade. Numerous small pink flowers, fine for rocks or edging; foliage makes a solid carpet. Pkt. 30c.
- 7242 **SEDUM spurium coccineum** (Stonecrop). 6 in. July and Aug. Sun. Showy rosy crimson flowers. They thrive in almost any soil. Pkt. 25c.
- 7262 **SILENE schafta** (Autumn Catchfly). 4 to 6 in. July to Oct. When in flower, they are a mass of bright pink. Pkt. 20c.
- 8162 **TUNICA saxifraga** (Coat-flower). 6 in. Beautiful tufted plant with light pink flowers produced all Summer. Fine for either border or rockery. Pkt. 20c.
- 8223 **VERONICA incana (candida)**. 1 ft. July-Aug. A white, wooly plant with numerous blue flowers. Makes a fine show even when not in bloom. Pkt. 25c.
- 8224 **VERONICA rupestris**. 3 to 4 in. Covered in early June with a solid mass of bright blue flowers. Foliage a deep green. A fine rock plant for many places. Pkt. 25c.

Other seeds of rock garden plants to be found in catalog

Hardy Varieties: Alyssum saxatile compactum, Achillea, Arabis, Armeria, Asperula, Aubrietia, Campanula carpatica, Cerastium, Cheiranthus, Dianthus deltoides, Edelweiss, Geum, Helianthemum mutabile, Heuchera, Iberis (Perennial Candytuft), Linum, Primula (hardy varieties), Sedum.

Annual Varieties: Alyssum, Dwarf; Antirrhinum, Tom Thumb varieties; Candytuft, dwarf varieties; Marigold, dwarf varieties; Mesembryanthemum; Petunia, dwarf varieties; Portulaca; Silene; Viola cornuta, Zinnia Lilliput, and Gem varieties.

Specialties in Vegetable Seeds

PEDIGREED ASPARAGUS

MARY WASHINGTON. It is earlier, produces more, has larger stalks, possesses highest rust resistance and will net a great deal more money per acre than the Martha Washington. We have a limited supply of carefully selected two-year-old roots. \$2.00 per 100, \$18.00 per 1000. Seed pkt. 10c., oz. 50c., $\frac{1}{4}$ lb. \$1.50.

BEANS

ABUNDANCE. An extra early variety, producing a heavy crop of long, stringless pods of excellent flavor. For forcing in the greenhouse during Winter it cannot be surpassed. Pt. 35c., qt. 60c.

ASGROW VALENTINE. An extremely early entirely stringless Bean. Pods $6\frac{1}{2}$ to 7 in. long and of excellent flavor. Pt. 35c., qt. 60c.

MASTERPIECE STRINGLESS BUSH. A fine variety for exhibition and for those who demand quality. Pt. 40c., qt. 75c.

SUTTON'S SATISFACTION. A first early variety producing a heavy crop of long, deep green pod; when young they are perfectly stringless. An excellent forcing variety. Pt. \$1.25, qt. \$2.00.

TENDERGREEN. An early, round podded variety, the pods are meaty and of handsome appearance, absolutely stringless and of excellent flavor. Pt. 50c., qt. 90c.

THE PRINCE (Sutton's). A first early variety producing a heavy crop of long, meaty pods, often measuring from 11 to 12 in. in length. Absolutely stringless and of excellent flavor. Pt. \$1.25, qt. \$2.00.

BEET

EARLY WONDER. It is an ideal all season Beet, for while it grows a nice size it retains its tender quality throughout the season. Pkt. 10c., oz. 25c., $\frac{1}{4}$ lb. 75c.

CROSBY'S EGYPTIAN. Selected. (Arlington grown). One of the earliest dark leaved varieties; fine quality. Pkt. 15c., oz. 50c., $\frac{1}{4}$ lb. \$1.50, lb. \$4.00.

CABBAGE

CHINESE WONG BOK. The culture for Wong Bok is the same as for late Cabbage. When well grown the plants should be blanched by tying loosely with burlap. Pkt. 10c., oz. 35c.

DANISH BALL HEAD. A Winter Cabbage. Extra hard-headed of fine quality. Pkt. 10c., oz. 50c., $\frac{1}{4}$ lb. \$1.50.

THE GOLDEN ACRE. A new Cabbage, head measuring 9 in. in diameter; 10 days earlier than Copenhagen Market and more compact. Pkt. 25c., oz. 75c.

CARROT

CHANTENAY (Morse's Red Cored). Excellent medium early half-long, stump-rooted variety, $5\frac{1}{2}$ to 6 in. long. Very thick, smooth and of a deep orange color. An excellent table Carrot. Pkt. 10c., oz. 25c., $\frac{1}{4}$ lb. 75c.

DANVERS HALF-LONG IMPROVED. Special strain. Grown for us by a leading market gardener in Danvers. Pkt. 15c., oz. 50c., $\frac{1}{4}$ lb. \$1.50.

HUTCHINSON'S STRAIN. A very fine Carrot, 8 to 9 in. long, nearly the same size the whole length and stump-rooted. Color deep orange and of fine quality. Pkt. 15c., oz. 75c., $\frac{1}{4}$ lb. \$2.75.

CELERY

GIANT PASCAL (Arlington grown). This is the most profitable Celery for Fall or Winter use, the stalks being broad, thick, solid, crisp and of rich, nutty flavor. This strain is remarkably free from soft, pithy stalks. Pkt. 10c., oz. \$1.00, $\frac{1}{4}$ lb. \$3.50.

GOLDEN PLUME. It is considered by many gardeners the best of all early varieties. Pkt. 10c., oz. \$1.00, $\frac{1}{4}$ lb. \$3.50.

EASY BLANCHING. The plants make a rapid and vigorous growth, producing rather thick, solid stalks of excellent quality and rich, nutty flavor. Pkt. 15c., oz. \$1.50.

CORN, SWEET

GOLDEN SUNSHINE. The earliest of the Golden Bantam type; more dwarf in habit, with ears $6\frac{1}{2}$ in. long, containing 12 rows of broad, yellow, sweet grains, especially desirable for its extreme earliness. Pt. 30c., qt. 50c., pk. \$3.50.

SPANISH GOLD. Grows from 5 to 6 ft. high and produces one or more good sized ears on each stalk. Ripens early and has much of the tenderness and flavor of Golden Bantam. Pt. 30c., qt. 50c., pk. \$3.50.

LETTUCE

MAY KING (Selected Strain). As a Lettuce for greenhouse forcing, this is the best; the heads form very quickly and are firm and of fine quality. Pkt. 15c., oz. 75c., $\frac{1}{4}$ lb. \$2.25.

SUTTON'S SUPREME. A fine Lettuce of the Drumhead type, which remains good for a long time before starting seed stems. Leaves prettily edged with red. Pkt. 25c.

WHITE BOSTON. A sure, hard heading variety, the heart and inner leaves are a rich yellow. It is deliciously flavored, very tender, of splendid quality. Pkt. 10c., oz. 40c.

MELONS

COTTING'S HYBRID. Flesh orange, oval-shaped, carries three to four Melons to plant. Weight 5 to 6 lbs. each. Pkt. 50c.

HALE'S BEST. An early variety, flesh is very thick and fine grained, deep salmon pink in color and richly flavored. Pkt. 10c., oz. 25c., $\frac{1}{4}$ lb. 75c.

HEARTS OF GOLD. A splendid small, midseason variety. Flesh very thick, deep salmon color, and of high quality; a good shipping Melon. Pkt. 10c., oz. 25c., $\frac{1}{4}$ lb. 75c.

LAKE CHAMPLAIN (Golden Champlain). An exceedingly early salmon-fleshed Melon of medium size and fine quality. Pkt. 10c., oz. 50c., $\frac{1}{4}$ lb. \$1.50.

SUTTON'S A-1. Rich scarlet flesh, large globular fruits; fine flavor. Pkt. 50c.

SUTTON'S UNIVERSAL. Fruits large, flesh is white and very thick, flavor exceptionally fine. Pkt. 50c.

SPECIALTIES IN VEGETABLE SEEDS—Continued

ONION

AILSA CRAIG. A handsome variety. Globe-shaped, flesh white, with pale yellow skin. A favorite for exhibition. Pkt. 25c., oz. \$1.00.

CRANSTON'S EXCELSIOR. Handsome, globe-shaped variety, large, solid with small neck, straw color; an exhibition variety. Pkt. 25c., oz. \$1.00.

DANVER'S YELLOW GLOBE (Selected Strain). The finest type of this popular variety in the market. Grown for us by an Onion specialist in Danvers, Mass. Pkt. 25c., oz. \$1.00, $\frac{1}{4}$ lb. \$3.00.

GIGANTIC GIBRALTAR. A handsome straw colored Onion of enormous size, possessed of many sterling qualities. Grand for exhibition. Pkt. 25c., oz. \$1.00.

PEAS

ONWARD. Decidedly the best Pea of recent introduction; pods are 4 in. long with 6 to 8 deep green peas of the finest flavor. Pt. 50c., qt. 90c.

LAXTON'S PROGRESS. This is the finest new early dwarf Pea Laxton has ever yet raised; wrinkled, averaging 9 to 10 peas in a pod. Pods dark green, height 18 to 24 in. Pt. 40c., qt. 75c.

SUTTON'S SUPER V. C. The largest podded Pea in existence; height from 5 to 6 ft., large pods of fine flavor and exhibition variety. Pt. 75c., qt. \$1.25.



THE BRITISHER PEA. A prolific, strong growing variety with medium green foliage. Pods are perfectly straight, pointed at the ends, and of a medium green color, containing nine large, nicely flavored Peas. 4 ft. Main crop; wrinkled. Pt. \$1.00, qt. \$1.75.

PARSLEY

DOBBIE'S EXHIBITION. This Parsley has long been recognized as a standard exhibition sort. It is remarkable for its large, fine leaves and close habit. The seed offered has been saved from selected plants only, every one of which was a perfect specimen. Pkt. 25c., oz. 75c.

SQUASH

DELICIOUS. One of the best varieties for table use. It is a Fall and Winter Squash, excellent at all seasons. Pkt. 10c., oz. 25c., $\frac{1}{4}$ lb. 75c.

GIANT STRAIGHT NECK SUMMER. A type nearly double the size of any other Summer Squash. Despite its large size the flesh is rich and fine flavored. Pkt. 15c., oz. 50c., $\frac{1}{4}$ lb. \$1.50, lb. \$5.00.

HUBBARD SYMMES BLUE. A superior strain, thick meated, fine grained, dry and very sweet. A heavy cropper and good keeper. Pkt. 10c., oz. 35c., $\frac{1}{4}$ lb. \$1.25.

THE WARREN. Resembles the Essex Hybrid, but has a shell generally harder and thicker. The color is of a richer and deeper orange. The flesh is of excellent quality. Pkt. 10c., oz. 50c., $\frac{1}{4}$ lb. \$1.50.

SPINACH

NOBEL, GIANT-LEAVED. By far the best of the so-called smooth-leaved varieties. It grows rapidly and remains a long time in marketable condition. Oz. 15c., $\frac{1}{4}$ lb. 35c., lb. \$1.25.

SAVOY BLIGHT-RESISTING. On account of its resistance to blight, the yield is often very large. A valuable variety to use for Fall sowing. Oz. 15c., $\frac{1}{4}$ lb. 35c.

SAVOY-LEAVED, LONG-STANDING. Darker green and more heavily crumpled than Bloomsdale; will stand 10 days longer before bolting to seed. Oz. 15c., $\frac{1}{4}$ lb. 35c.

TOMATO

BREAK O'DAY. An early Tomato of the Marglobe type; fruit of good size, color scarlet, smooth and of good quality. Pkt. 15c., oz. \$1.00, $\frac{1}{4}$ lb. \$3.00.

COMET. One of the best for forcing; brilliant scarlet color; medium size, smooth and solid. Pkt. 10c., oz. 75c., $\frac{1}{4}$ lb. \$2.25.

LISTER'S EXCELSIOR. This variety is the result of a cross between Ailsa Craig and Lister's Prolific, one of the best for forcing or outdoor culture; a heavy cropper of good flavor and color. Original pkts. 35c.

LISTER'S PROLIFIC. Clusters of fruit are borne in great profusion and are remarkable for the number they carry; smooth and of a rich scarlet color. Original pkts. 35c.

LISTER'S PROTECTION. A new variety—the best of Lister's productions. Color dark crimson, a heavy cropper; perfect in shape and size. Pkt. 75c.

MARGLOBE. Of recent introduction. A midseason variety entirely immune from rust, pure scarlet, globe-shaped. Good size, heavy cropper and fine quality. Pkt. 10c., oz. 50c.

SCOTT'S ELLENBANK. A new variety, very large, cropper, carrying trusses from 3 to 4 lbs. One of the best Tomatoes for indoor or outdoor cultivation. Original pkts. 75c.

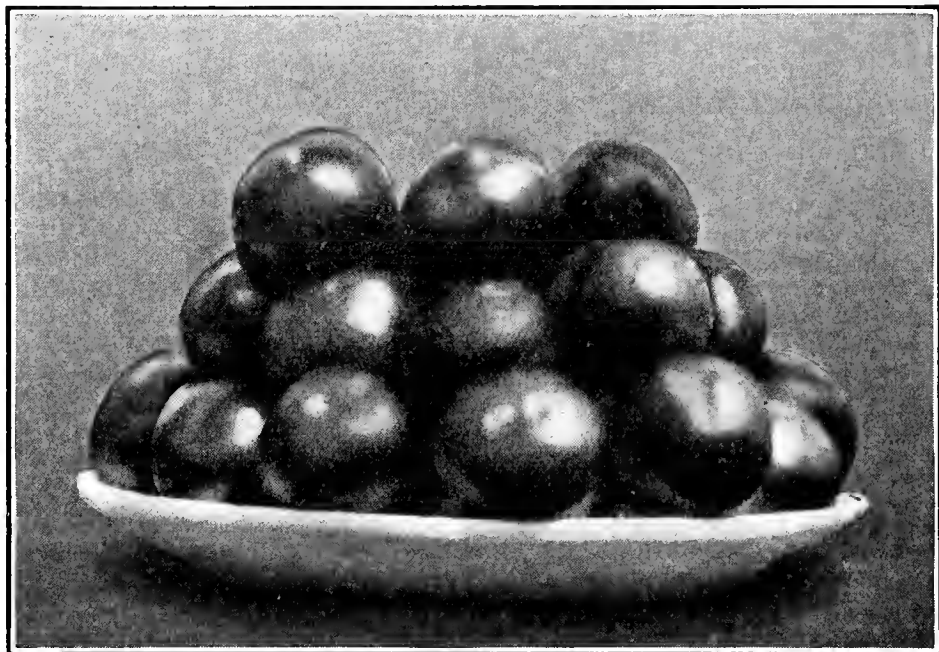

Bonnie Best (See page 22)



A collection of 110 varieties of vegetables. The seed was supplied by Thomas J. Grey Company

GENERAL LIST OF Vegetable Seeds

OUR VEGETABLE SEEDS ARE OF THE HIGHEST STANDARD
GROWN FOR US BY SPECIALISTS
OUR AIM IS PURITY, QUALITY AND SERVICE

SEEDS BY MAIL

We deliver free of expense to the purchaser to any point in the United States all seeds quoted in this list at packet and ounce price.

ARTICHOKE

Large Green Globe. The best variety; heads large and scales tender and excellent. Pkt. 25c., oz. \$1.00.

Jerusalem (*Helianthus tuberosus*). Cultivated for its edible tubers. April delivery only. Tubers, qt. 40c., pk. \$2.50.

ASPARAGUS

One ounce will produce 200 plants

A deep, rich, mellow soil is best adapted to the growth of Asparagus. It may be grown from seed or propagated by roots. Sow as early in the Spring as the ground will admit, in drills from 12 to 14 inches apart, and cover 1 inch deep; when the plants are well up, thin to 3 inches apart in the drills. Keep the plants free from weeds during Summer, and protect slightly during Winter.

The following Spring the roots will be ready to transplant into permanent beds; the roots should be set in rows 3 to 4 feet apart, and 1 foot apart in the rows; the crown of the root should be 4 to 6 inches below the surface of the ground. A fair crop may be expected the third year from the seed, or in one or two years when roots are used, according to the age of the roots planted. By planting two-year-old roots a fair crop may be obtained in one year, and after that a full crop every year.

Mary Washington. The latest improved variety. Very large shoots, early, vigorous and quite rust-resistant. Pkt. 10c., oz. 50c., $\frac{1}{4}$ lb. \$1.50.

Martha Washington. Pkt. 10c., oz. 50c., $\frac{1}{4}$ lb. \$1.50.

Reading Giant. A variety of recent introduction, very large and free from blight. Pkt. 10c., oz. 50c., $\frac{1}{4}$ lb. \$1.50.

ASPARAGUS ROOTS

Mary Washington. Select roots. \$2.00 per 100, \$18.00 per 1000.

Martha Washington. \$2.00 per 100, \$18.00 per 1000.

Reading Giant. \$1.50 per 100, \$12.00 per 1000.

BEANS, Dwarf or Bush

One quart will plant 100 feet of drill. One and one-half bushels will plant one acre

A warm, light soil is best adapted to the growth of Bush Beans, but they will do well in almost any situation unless it is very wet. Plant in rows 2 to 3 feet apart, dropping the beans 3 inches apart and covering 2 inches. Keep the ground free from weeds and cultivate often. Never disturb the vines when wet, as the pods become rusty. All the varieties are tender and must not be planted until the soil is dry and warm.

If by mail, add Parcel Post rate to cover postage. One quart weighs about 2 pounds. We furnish 20c. packets of all Beans except where noted.

WAX-PODDED VARIETIES

- Black Wax, Improved Prolific.** Early, very tender and of good quality. Pt. 35c., qt. 60c.
- Black Wax Pencil Pod.** Pods are long, pencil-like, very tender and brittle. Pt. 35c., qt. 60c.
- Brittle Wax.** The best of the round podded sorts, maturing early, prolific, and bearing long, stringless pods of excellent quality. Pt. 35c., qt. 60c.
- Burpee's Kidney Wax.** Of excellent quality. Pods long, stringless and free from rust. Pt. 35c., qt. 60c.
- Currie's Rustproof.** Pods long, flat, straight and of a waxy white color; quality excellent. Pt. 35c., qt. 60c.
- Davis' Kidney Wax.** Plant vigorous and of compact, upright growth, with pods extra long, straight, oval. Pt. 35c., qt. 60c.
- Golden Wax.** The standard variety for general use; pods long, broad and flat, very fleshy and of finest quality. Vines erect, hardy and productive. Pt. 35c., qt. 60c.
- Hodson Wax.** Very large, brittle, tender wax pods and very productive. Pt. 30c., qt. 50c.

- Round Pod Kidney Wax.** The pods are long, straight and extremely handsome. It is an exceedingly heavy bearer. Pt. 35c., qt. 60c.
- Sure Crop Stringless Wax.** A valuable new variety of dwarf wax Beans, very productive, rustproof, and will stand a longer season of damp, wet weather than any other wax Bean. Pt. 35c., qt. 60c.
- Wardwell's Kidney Wax.** Very long, straight, tender pods. Vines large, vigorous and productive. Pt. 35c., qt. 60c.
- Webber Wax or "Cracker Jack."** A high quality, flat-podded, stringless variety of the season. Pods 6 to 6½ in. long, quite broad and uniformly curved, fleshy, stringless and brittle, with little fiber. Pt. 35c., qt. 60c.

GREEN-PODDED VARIETIES

- Abundance.** An extra early variety, producing a heavy crop of long, stringless pods of excellent flavor. Pt. 35c., qt. 60c.
- Asgrow Valentine.** An extremely early entirely stringless Bean. Pods 6½ to 7 in. long and of excellent flavor. A fine variety for the private estate and commercial grower. Pt. 35c., qt. 60c.
- Bountiful.** Extra early, very prolific and long bearing, flat green pods, tender and stringless. Pt. 30c., qt. 50c.
- Broad Windsor (Sutton's White).** English variety, very hardy. Pt. 40c., qt. 75c.
- Emperor of Russia.** Extremely prolific and highly esteemed where known. Pods long, slender and meaty. Medium early. French grown. Pt. 50c., qt. 90c.
- Full Measure.** Firm, tender, large round pods, entirely stringless. Pt. 35c., qt. 60c.
- Giant Stringless, Green Pod.** Color deep green, very long, round, fleshy pods; very prolific and entirely stringless. Pt. 35c., qt. 60c.
- Horticultural French's Dwarf.** An improved form of Dwarf Horticultural, producing long pods, beautifully splashed with bright crimson, heavy cropper. Pt. 40c., qt. 75c.
- Lima, Burpee's Improved Bush.** Best dwarf Lima Beans, large and delicious. Pt. 50c., qt. 90c.
- Lima, Dreer's Bush.** Possesses all the good qualities of the Dreer's Pole Lima. Pt. 50c., qt. 90c.
- Lima, Fordhook Bush.** Pods and beans twice the size of Dreer's Lima, and earlier. Pt. 55c., qt. \$1.00.
- Lima, Henderson's Bush.** Pods and beans small; of excellent quality as a shell Bean. Pt. 40c., qt. 75c.
- Longfellow.** Long, straight, round, solid green pod, very early. Pt. 35c., qt. 60c.
- Low's Champion.** One of the best for Snap or shell, with stringless, large, green, flat pods. Pt. 35c., qt. 60c.
- Masterpiece Stringless Bush.** A fine variety for exhibition and for those who demand quality. Pt. 40c., qt. 75c.
- Plentiful, Sutton's.** One of the earliest varieties and one which we can confidently recommend for all gardens, and especially where forcing is practiced. Pt. 40c., qt. 75c.

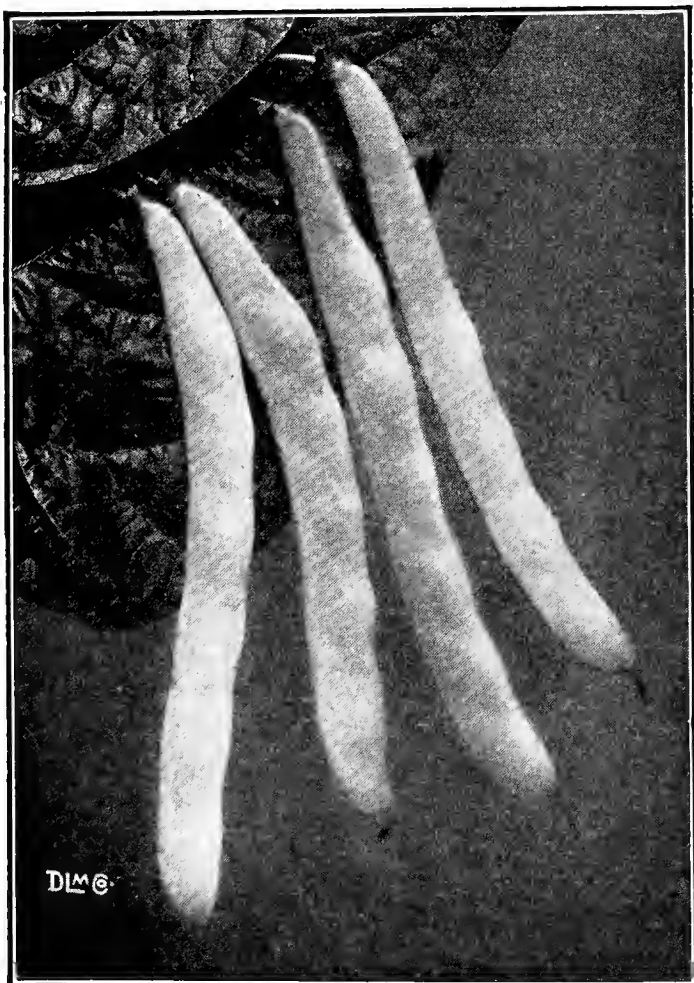

For Specialties in Beans, See Page V.

BEANS, Green-podded Varieties—Continued

- Refugee, Extra Early.** Pods green, round, quality excellent, extremely early and prolific. Pt. 30c., qt. 50c.
- Refugee, Late, or 1000 to 1.** Very tender and productive; the best variety for pickling. Pt. 30c., qt. 50c.
- Stringless Green Pod, Burpee's.** Extra early, prolific, round pod and stringless. Pt. 30c., qt. 50c.
- Sutton's Satisfaction.** A first early variety, producing a heavy crop of long, deep green pods; when young they are perfectly stringless. An excellent forcing variety. Pt. \$1.25, qt. \$2.00.
- Tendergreen.** An early, round podded variety, the pods are meaty and of handsome appearance, absolutely stringless, and of excellent flavor. Pt. 50c., qt. 90c.
- The Prince (Sutton's).** A first early variety producing a heavy crop of long, meaty pods, often measuring from 11 to 12 in. in length. Absolutely stringless and of excellent flavor. Pt. \$1.25, qt. \$2.00.
- Triumph of the Frames.** The earliest French forcing variety. Pt. 40c., qt. 75c.
- Valentine, Black.** Long, round, solid pods; very early. Pt. 30c., qt. 50c.
- Wonder of France.** A valuable French variety for forcing. Pt. 40c., qt. 75c.

Beans, Pole or Running

One quart will plant about 150 hills

All under this head require poles 6 to 8 feet long and should not be planted until the ground is warm, as they are more tender than the dwarf varieties. Plant about the middle of May if the season is suitable. The Lima Beans are very susceptible to cold and wet, and apt to rot in the ground, and should not be planted until all danger from frost is over and the soil is dry and warm.



- Burger's Stringless Green-Pod.** In some sections this is called White-seeded Kentucky Wonder. It is earlier and covers a longer season of productiveness. The pods, borne in clusters, average 6 to 8 in. in length. Pt. 40c., qt. 75c.
- Dutch Case-Knife.** Very early and prolific; fine shelled, green or dry. Pt. 40c., qt. 75c.
- Golden Cluster, Dreer's.** Pods a beautiful golden yellow, from 6 to 8 in. long, produced in clusters of four to six. The earliest of the pole wax Beans and very productive. Quality excellent. Pt. 40c., qt. 75c.
- Improved Kentucky Wonder (Old Homestead).** Excellent, very productive. Pods a silvery-green color of large size and entirely stringless. Pt. 30c., qt. 50c.
- Italian Pole (New).** A green-podded pole string Bean, slightly streaked with purple, absolutely stringless, unsurpassed for a string or shell Bean. Pt. 75c., qt. \$1.35.
- Kentucky Wonder Wax.** A Wax Pole Bean with all the good qualities of old Kentucky Wonder or Old Homestead. Pt. 40c., qt. 75c.
- King Horticultural (Worcester).** Early and productive. The long, beautifully colored pods hang in rich clusters. A greatly improved pole horticultural. Pt. 40c., qt. 75c.
- Lazy Wife.** Pods long, stringless and of a rich buttery flavor. Pt. 40c., qt. 75c.
- Lima, Carpinteria.** A large-seeded variety of vigorous growth. Pods large and well filled with Beans of excellent flavor. Pt. 50c., qt. 90c.
- Lima, Dreer's Improved or Challenger.** An improved Lima, different in shape, being much thicker than the old Lima and superior in quality. Pt. 50c., qt. 90c.

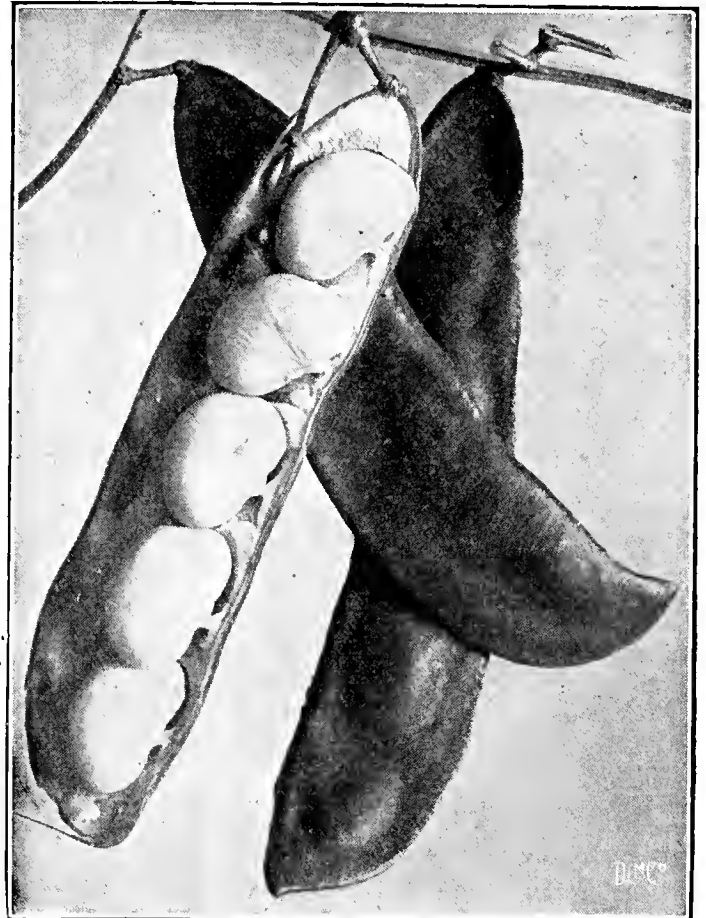

Dreer's Improved Lima

- Lima, Siebert Early.** An immense yielder and excellent quality. Pt. 50c., qt. 90c.
- Lima Sieva, or Small.** A popular small-seeded variety. Pt. 40c., qt. 75c.
- Mont d'Or, or Golden Butter.** A strong, vigorous grower, with pods 6 to 8 in. long in clusters, thick and fleshy. Pt. 50c., qt. 90c.
- Runner, Scarlet.** Bright scarlet flowers. Used both as a string and shelled Bean. Pt. 40c., qt. 75c.
- Runner, White.** Very effective planted with the Scarlet Runner. Pt. 40c., qt. 75c.

DWARF SHELL BEANS

- Improved Yellow Eye.** One of the best sorts for baking, extremely productive and of superior quality. Pt. 25c., qt. 40c., 4 qts. \$1.50.
- Vermont Pea Bean.** A most productive small white baking variety, of superior quality. Pt. 25c., qt. 40c., 4 qts. \$1.50.
- Red Kidney.** Popular baking Bean. Pt. 25c., qt. 40c., 4 qts. \$1.50.

BROCCOLI

One ounce will produce 2000 plants

This vegetable closely resembles the Cauliflower. A very rich, deep soil is required to grow the Broccoli to perfection, the seed should be sown early in the Spring and the plants transplanted into rows 3 feet apart, with 2 feet between the plants.

- Early Green Calabrese.** A distinct variety forming good sized green heads; this vegetable resembles the Cauliflower with the combined Cauliflower and Asparagus flavor. Seed imported. Pkt. 25c., oz. \$1.50, ¼ lb. \$5.00.
- White Cape.** Heads compact, good size, and of a creamy white. Pkt. 10c., oz. \$1.00.

BEET

One ounce will sow 50 feet of drill; 5 to 6 lbs. an acre.

A deep, light, sandy loam that has been well enriched is best adapted to the growth of the Beet. Sow in drills from April until July, 16 inches apart and about 1 inch deep; thin the plants to about 3 inches apart. The Turnip-rooted are the best, and all early varieties are used extensively for greens.

Bastian's Early. Of quick and large growth; bright red color. Pkt. 10c., oz. 20c., $\frac{1}{4}$ lb. 50c., lb. \$1.50.

Crimson Globe. Early, of globe shape, and rich, deep crimson flesh. Pkt. 10c., oz. 20c., $\frac{1}{4}$ lb. 50c., lb. \$1.50.

Crosby's Egyptian, Selected, Arlington Grown. One of the earliest dark-leaved varieties; fine quality. Pkt. 15c., oz. 50c., $\frac{1}{4}$ lb. \$1.50, lb. \$4.00.

Crosby's Egyptian. One of the earliest dark red varieties; fine quality. Very popular among market gardeners. Pkt. 10c., oz. 25c., $\frac{1}{4}$ lb. 75c., lb. \$2.00.

Detroit Dark Red. Round and smooth, deep red, very tender. Pkt. 10c., oz. 25c., $\frac{1}{4}$ lb. 75c., lb. \$2.00.

Dewing's Blood Turnip. Of fine form and flavor; deep red. A desirable variety. Pkt. 10c., oz. 20c., $\frac{1}{4}$ lb. 50c., lb. \$1.50.

Early Eclipse. Early, globe-shaped, dark red, small top, smooth roots. Pkt. 10c., oz. 20c., $\frac{1}{4}$ lb. 50c., lb. \$1.50.

Early Wonder. The most perfect model of an extra early round Beet. The flesh is deep blood-red crimson. It is an ideal all season Beet, for while it grows a nice size Beet early, it retains its tender quality throughout the season. Pkt. 10c., oz. 25c., $\frac{1}{4}$ lb. 75c.

Edmand's. Deep blood-red color, round and smooth, excellent quality; highly recommended. Pkt. 10c., oz. 20c., $\frac{1}{4}$ lb. 50c., lb. \$1.50.

Grey's Blood Turnip. One of the very best strains for market gardeners; small top, round, handsome and very dark red. Pkt. 10c., oz. 25c., $\frac{1}{4}$ lb. 75c., lb. \$2.00.

Perpetual, or Spinach Beet. Producing green leaves in abundance close to the ground. This variety will give a constant supply of Spinach throughout the season. Pkt. 10c., oz. 25c., $\frac{1}{4}$ lb. 75c.

Swiss Chard. The leaves are used as Spinach, and the midrib of the leaf, cooked and served up like Asparagus, is delicious. Pkt. 10c., oz. 20c., $\frac{1}{4}$ lb. 50c.

Swiss Chard, Lucullus. A tall-growing variety, crinkled leaves, tender and of fine flavor. Pkt. 10c., oz. 20c., $\frac{1}{4}$ lb. 50c.

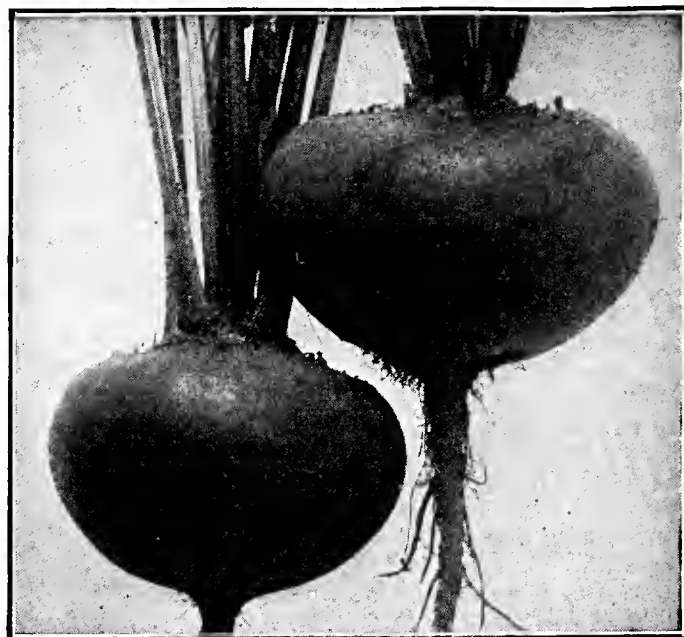

Early Wonder

SUGAR BEET and MANGEL WURZEL

Sow in April or May, using 6 to 10 lbs. of seed to the acre.

Danish Sludstrup. Very high yielder. Roots long, oval, orange colored; flesh white with faint yellow tinge. Oz. 10c., $\frac{1}{4}$ lb. 25c., lb. 75c.

Grey's Prize Long Red Mangel Wurzel. The most largely grown of any of the Mangels; roots attain an enormous size, producing 30 to 50 tons to the acre; quality superior, the best for deep soil. Oz. 10c., $\frac{1}{4}$ lb. 35c., lb. \$1.00.

Golden Tankard Mangel Wurzel. The flesh is bright golden yellow; very large, and will produce more Mangels to the acre than any other variety; excellent for feeding stock. Oz. 10c., $\frac{1}{4}$ lb. 25c., lb. 75c.

Giant Yellow Intermediate Mangel Wurzel. A very large yellow sort, of good quality, and produced in great abundance. Oz. 10c., $\frac{1}{4}$ lb. 25c., lb. 75c.

Lane's Improved Sugar Beet. Large, hardy, productive and excellent quality. Oz. 10c., $\frac{1}{4}$ lb. 25c., lb. 75c.

Norbiton Giant Mangel Wurzel. Long red. A valuable variety for deep soil; very productive. Oz. 10c., $\frac{1}{4}$ lb. 25c., lb. 75c.

Red Globe. Similar to Yellow Globe except in color. Oz. 10c., $\frac{1}{4}$ lb. 25c., lb. 75c.



Brussels Sprouts, Dobbie's Exhibition

BRUSSELS SPROUTS

One ounce will produce 2000 plants.

Cultivated for the small heads that grow from the main stem; these small heads are firm and compact, like little Cabbages, and are considered a great delicacy by many people. Cultivate the same as Cabbage or Cauliflower.

Aigburth. Very large sprouts; hardy and productive. Pkt. 10c., oz. 50c., $\frac{1}{4}$ lb. \$1.50.

Dobbie's Exhibition. Grows taller than the above; is of good quality and very productive. Pkt. 25c., oz. \$1.25.

Improved Dwarf French. Tender and of fine flavor. Pkt. 10c., oz. 75c.

Long Island Improved. Very compact heads; productive. Pkt. 25c., oz. \$1.25.

CABBAGE

One ounce produces about 3000 plants

For early use a sowing may be made in the hotbed in February or March, and for Winter use seed should be sown in the open ground in May or June. When the plants are 5 or 6 inches in height, transplant into rows 3 to 3½ feet apart, setting the plants from 2 to 3 feet apart in the rows, according to the variety. A deep, rich, loamy soil is best adapted to the growth of this crop, and if large, fine heads are expected, the land must be prepared by very heavy manuring. A handful of wood ashes thrown into the forming heads will not only keep off the cabbage-fly, but will assist the growth of the plants to a considerable extent. Slug Shot is equally effective.

All-Seasons. An early drumhead, sure heading, solid variety. Desirable for early or Fall use. Pkt. 10c., oz. 35c., ¼ lb. \$1.25.

All-Head. Earliest of the large Cabbages; heads uniformly solid. Pkt. 10c., oz. 35c., ¼ lb. \$1.25.

American Improved Savoy. The favorite curled Savoy Cabbage of finest quality, and an excellent keeper. Pkt. 10c., oz. 35c., ¼ lb. \$1.25.

Autumn King. The heads are of enormous size and very solid. Pkt. 10c., oz. 35c., ¼ lb. \$1.25.

Baby Head Cabbage. Introduced by one of the best Cabbage growers in Denmark. This is an extra early round, hard headed Cabbage, 10 days earlier than any other round headed variety. The heads are small and of fine quality. We recommend Baby Head Cabbage for greenhouse growing and where space is limited. The seed we offer is grown for us in Denmark. Pkt. 15c., oz. 75c.

Charleston, or Large Wakefield. This strain is about one week later than early Jersey Wakefield. Pkt. 10c., oz. 35c., ¼ lb. \$1.25.

Chinese Wong Bok. This is the famous Chinese Celery Cabbage. It has wide midribs at the base and merges into crisp, tender leaves at the top, the whole being very compact and heavy. It blanches to almost clear white. The culture for Wong Bok is the same as for late Cabbage. Well grown plants should be blanched by tying loosely with burlap. Pkt. 10c., oz. 35c., ¼ lb. \$1.25.

Copenhagen Market. As early as Charleston Wakefield. Very solid. Excellent market sort. Pkt. 10c., oz. 75c., ¼ lb. \$2.50.

Danish Ball Head. A Winter Cabbage. Extra hard-headed of fine quality. Pkt. 10c., oz. 50c., ¼ lb. \$1.50.

Danish Round Head. A short-stemmed type of the Danish Ball Head, maturing earlier than that variety; excellent quality, large, solid, globe-shaped heads. One of the best Winter sorts. Pkt. 10c., oz. 50c., ¼ lb. \$1.50.

Earliest of All. Similar to Copenhagen Market, but much earlier. A Danish introduction. Pkt. 10c., oz. 35c.



Copenhagen Market

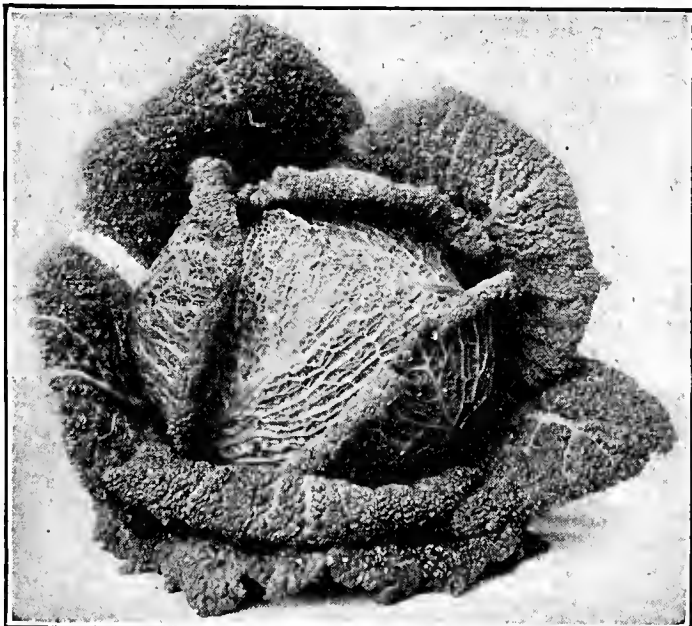

Globe Curled Savoy, Special Strain

Early Summer, Henderson's. A few days later than Wakefield, rather larger and more globe-shaped. Pkt. 10c., oz. 35c., ¼ lb. \$1.25.

Early Jersey Wakefield. One of the most popular early pointed varieties; good grower. Pkt. 10c., oz. 35c., ¼ lb. \$1.25.

Early Wonder Red. The earliest of all red Cabbages. The heads are large, solid and handsome, of delicious flavor, color dark red. Pkt. 10c., oz. 50c.

Early Winnigstadt. Pointed variety; both for early and late sowing. Pkt. 10c., oz. 35c., ¼ lb. \$1.25.

Fotler's Brunswick. The standard market variety; a drumhead; grows to a large size; solid, tender, good shape and a good keeper. Pkt. 10c., oz. 35c., ¼ lb. \$1.25.

Globe Curled Savoy. A variety with finely curled leaves and of delicate flavor; used for Fall crop or for Winter. Pkt. 25c., oz. 75c., ¼ lb. \$2.50.

Golden Acre. A new Cabbage, head measuring 9 in. in diameter; 10 days earlier than Copenhagen Market and more compact. Pkt. 25c., oz. 75c.

Mammoth Red Rock. The largest and surest heading Red Cabbage; heads as large and solid as Flat Dutch and fine grained. Pkt. 10c., oz. 35c., ¼ lb. \$1.25.

Marblehead Mammoth. The largest known variety, drumhead; sometimes growing to weigh over 50 pounds; reliable header. Pkt. 10c., oz. 35c., ¼ lb. \$1.25.

Penn State Ball Head. A large somewhat flattened form of the ball head, producing probably the largest tonnage per acre of any known variety. This is one of the best Winter varieties. Pkt. 15c., oz. 75c., ¼ lb. \$2.50.

Red Dutch Pickling. Used extensively for pickling; tender, medium size. Pkt. 10c., oz. 35c., ¼ lb. \$1.25.

Stone Mason. Select strain. One of the oldest and best known varieties; large size; drumhead; grown principally as a late Cabbage, and for Winter keeping. Pkt. 20c., oz. \$1.00, ¼ lb. \$3.50.

Cabbage Plants. See page 24.

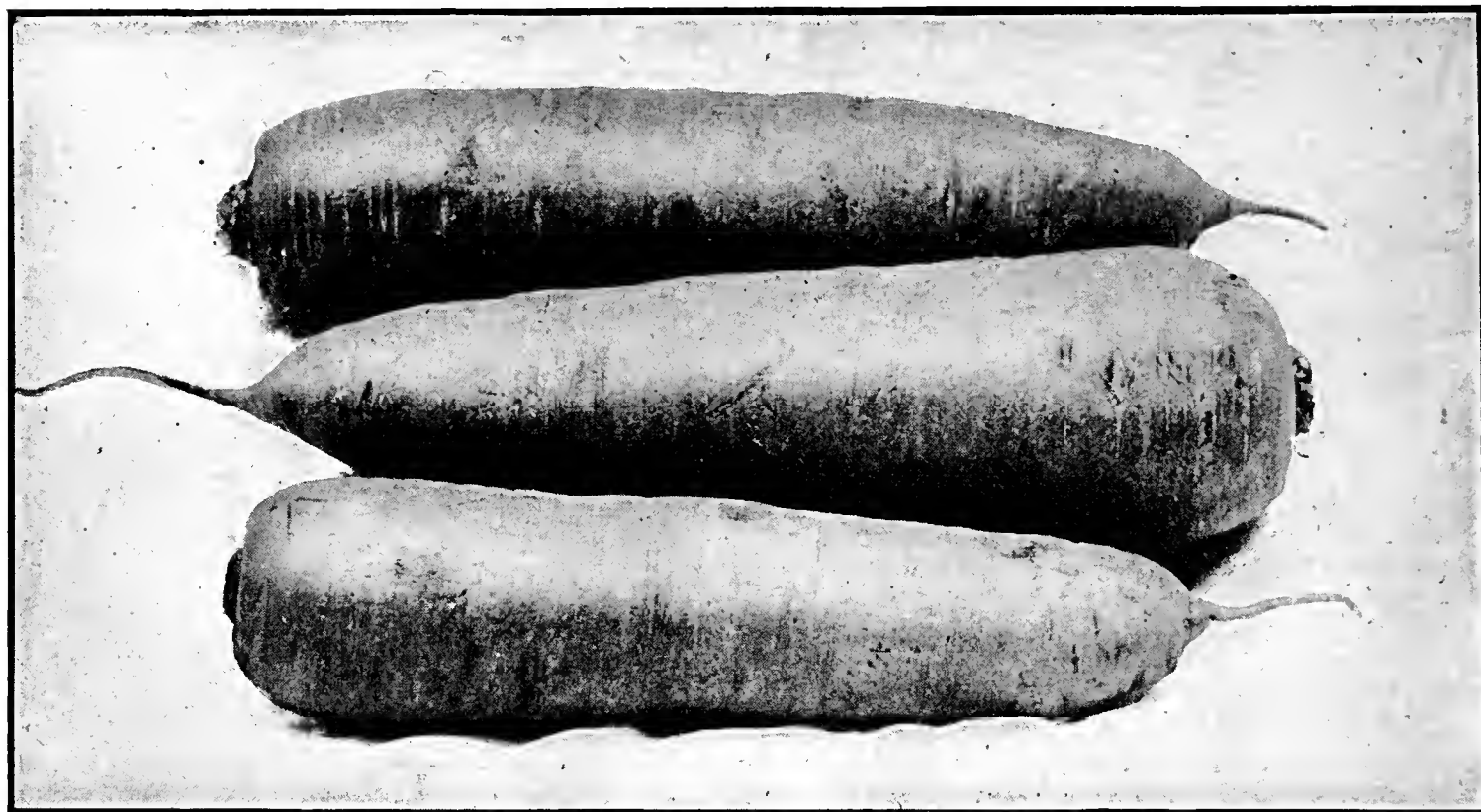

Carrots, Danvers Half-long Improved, Special Strain

CARROT

One ounce will sow 100 feet of drill, 3 lbs. required for one acre.

The Carrot flourishes best in a good, light, well enriched loam. Where there is a choice of situations, heavy and wet soils should be avoided, and preference given to the light and dry. For an early crop sow as soon as the ground is in good working condition; planting for general erop may be made as late as June, but early sowings succeed best. The early, small-sized varieties may be sown in drills 10 inches apart, but the larger sorts require at least 18 inches between the rows; cover about $\frac{1}{2}$ inch deep, and when the plants are well up, thin to 3 to 4 inches apart. As an agricultural root, the Carrot is unsurpassed for feeding stock.

We furnish packets of all varieties of Carrots at 10c. each, postpaid, except where noted.

Chantenay Half-long, Stump-rooted. The best sort for bunching, stump-rooted and a good color at all stages of growth. Oz. 25c., $\frac{1}{4}$ lb. 75c.

Danvers Half-long. The best variety for general crop; is of rich color and a good keeper; yields largely and is easily harvested. Oz. 25c., $\frac{1}{4}$ lb. 75c., lb. \$2.00.

Danvers Half-long Improved, Special Strain. Grown for us by a leading market gardener in Danvers. Pkt. 15c., oz. 50c., $\frac{1}{4}$ lb. \$1.50.

Earliest French Forcing. A small, round root; the earliest variety and good for forcing under glass. Pkt. 10c., oz. 25c., $\frac{1}{4}$ lb. 75c.

Early Scarlet Horn. A medium sized root, half long, of fine color, and much used for cooking; grown for early use and to sell in bunches. Oz. 25c., $\frac{1}{4}$ lb. 75c., lb. \$2.00.

Guerande or Oxheart. Intermediate length, 3 to 5 in. in diameter; fine quality. Oz. 25c., $\frac{1}{4}$ lb. 75c., lb. \$2.00.

Hutchinson Strain. A very fine Carrot, 8 to 9 in. long, nearly the same size the whole length and stump-rooted. Color deep orange and of fine quality. Pkt. 15c., oz. 75c., $\frac{1}{4}$ lb. \$2.75.

Half-long Scarlet Nantes. A stump-rooted variety of fine color. Oz. 30c., $\frac{1}{4}$ lb. 75c., lb. \$2.00.

Improved Long Orange. Excellent for stock or table use; roots deep orange. 12 to 15 in. Oz. 20c., $\frac{1}{4}$ lb. 60c., lb. \$1.50.

Improved Short White. The largest and heaviest cropping Carrot known; the roots are short, very heavy at the shoulder, of uniform shape and smooth. Oz. 20c., $\frac{1}{4}$ lb. 60c., lb. \$1.50.

James' Intermediate. The best intermediate variety tapering to a point; small core and of fine flavor. Oz. 25c., $\frac{1}{4}$ lb. 75c., lb. \$2.00.

Pride of Denmark. A wonderful fine Carrot, 8 to 9 in. long and 2 to 3 in. in diameter, being practically the same size the whole length. It closely resembles the Hutchinson, but has less core and deeper color. Pkt. 15c., oz. 75c., $\frac{1}{4}$ lb. \$2.75.

Chantenay. Morse's Red Cored. Excellent medium early, half long, stump rooted variety, $5\frac{1}{2}$ to 6 inches long. Very thick, smooth and of a deep orange color. An excellent table Carrot. Pkt. 10c., oz. 25c., $\frac{1}{4}$ lb. 75c.

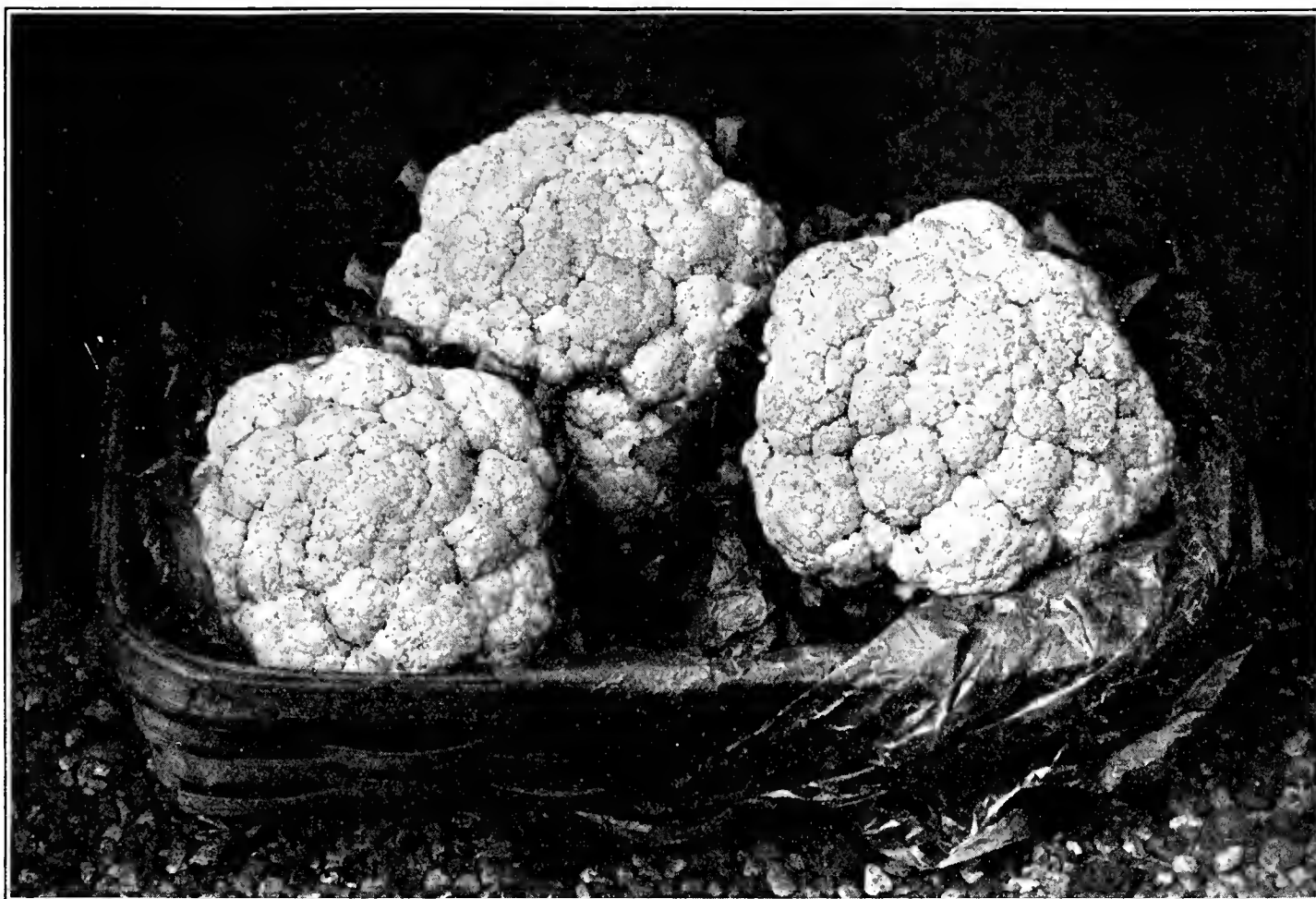

Cauliflower, Early Snowball, Grey's Selected

CAULIFLOWER

One ounce will produce 3000 plants.

The Cauliflower, like the Cabbage, requires a deep, rich soil and seldom succeeds well when grown on land long under cultivation. Sow the seed in the hotbed in March and transplant into the garden in May; set the plants in rows and cultivate the same as Cabbage. If the season is dry, water often, as Cauliflowers cannot be grown to perfection without plenty of moisture.

Danish Perfection. A very early variety of the Dwarf Erfurt type. The leaves are long, stand straight up, making the inner leaves curl over and protect the head. All the heads mature the same time, making it possible to clear the ground at one cutting. Pkt. 25c., oz. \$5.00.

Early Snowball. Grey's Selected. A favorite variety very sure to head. This strain has given excellent satisfaction during the many years we have sold it, and we believe no better strain can be found. Pkt. 25c., oz. \$5.00, ¼ lb. \$16.00.

Earliest Dwarf Erfurt. One of the earliest varieties; very dwarf, with large, white, compact heads of finest quality. Excellent for forcing. Pkt. 25c., oz. \$5.00, ¼ lb. \$16.00.

Early Dwarf Danish, or Dry Weather. A choice strain that comes to maturity very evenly; a favorite for first crop with many growers. Pkt. 25c., oz. \$4.00, ¼ lb. \$15.00.

Lenormand's Short-Stem. A large, late short-stemmed variety. Pkt. 10c., oz. \$1.50, ¼ lb. \$5.00.

Veitch's Autumn Giant. Heads very large, white and compact; well protected by foliage; will remain suitable for use a long time. Pkt. 15c., oz. \$1.00, ¼ lb. \$3.00.

CARDOON

Large Smooth. A tender and richly flavored variety which blanches easily. Pkt. 10c., oz. 50c., ¼ lb. \$1.50.

CHERVIL

Curled Chervil. Cultivated like Parsley. The young leaves for flavoring soups and salads and are also used for garnishing. Pkt. 10c., oz. 30c., ¼ lb. \$1.00.

CHICORY See Endive, page 11

Large-rooted Madgeburg. Roots when dried and roasted are used as a substitute for coffee. Pkt. 10c., oz. 35c., ¼ lb. 75c.

Witloof, or French Endive. This grows in a solid oblong head and blanches ivory white. One of the choicest of all Winter salads. Pkt. 10c., oz. 50c., ¼ lb. \$1.50.

CHIVES

Seed. Pkt. 25c., oz. \$1.00.

Roots. 30c. per clump, 12 clumps \$3.00. By mail, add 10c. extra for each clump.

CELERY

One ounce will produce about 4000 plants.

Sow the seeds in March or April in a hotbed or cold-frame. As soon as the plants are 3 inches high, transplant into a prepared border, setting them 4 inches apart. When grown 6 inches, and fine stocky plants, set in richly manured deep soil, in rows 3½ feet apart and about 9 inches from plant to plant. Water if dry weather follows transplanting. During the next two months all the attention required is to keep down weeds. Afterward earth up a little and continue doing so at intervals until only the tops of the leaves are visible late in Autumn. Never hoe or earth up when the plants are wet.

Boston Market (Arlington grown). The finest flavored variety in cultivation; solid, crisp and of excellent nutty flavor; dwarf, branching habit; blanches perfectly white; a splendid keeper. Pkt. 25c., oz. \$2.00.

Carter's Dwarf Crimson. Crisp, tender and delicious; a good keeper. Pkt. 25c., oz. \$1.50.

Celeriac or Turnip-rooted Celery, Giant Smooth Prague. Turnip-shaped roots which may be cooked, sliced and used in vinegar, also in soup; cultivated as Celery. Pkt. 10c., oz. 50c., ¼ lb. \$1.50.

Easy Blanching. The plants make a rapid and vigorous growth, producing rather thick, solid stalks of excellent quality and rich, nutty flavor. Pkt. 15c., oz. \$1.50.

Giant Pascal (Arlington grown). Of a fine, nutty flavor, entirely free from any bitter taste. It grows about 2 ft. high, the stalks being broad, thick, solid and crisp, with golden yellow heart. A valuable variety for both second early and Winter use. Pkt. 10c., oz. \$1.00, ¼ lb. \$3.50.

Golden Plume. An improved strain of Golden Self-blanching. The plants are of strong growth and produce thick and heavy stalks of excellent crisp and nutty flavor. Pkt. 10c., oz. \$1.00, ¼ lb. \$3.50.

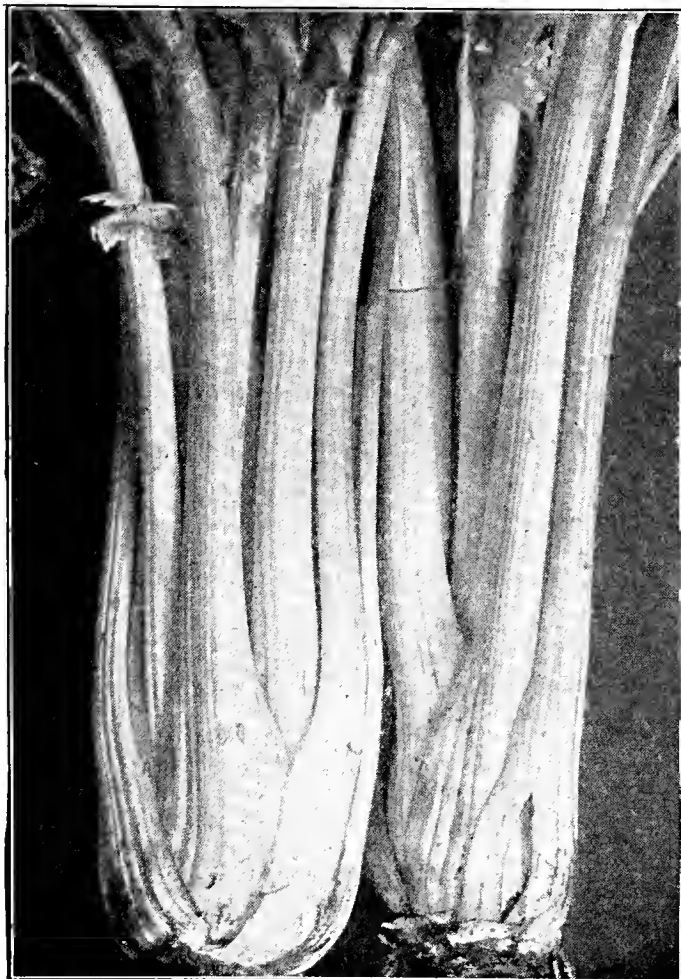

Golden Self-blanching



Giant Pascal

Newark Market. Green, easy blanching variety; stalks large and heavy, broad, solid, crisp and tender; a good keeper and will blanch in cold storage. Pkt. 15c., oz. \$1.50.

Paris Golden. Without doubt the finest early Celery in cultivation. The plant blanches quickly to a beautiful golden yellow; the stalks are brittle and have a fine, nutty flavor. Pkt. 10c., oz. \$1.00, ¼ lb. \$3.50.

White Plume. Ornamental; stalks and portions of leaves are naturally white. Pkt. 10c., oz. 75c., ¼ lb. \$2.25.

Winter Queen. This is one of the finest dwarf Winter Celeries. The plants make large bunches of extra heavy stalks with very large heart which, when blanched, are of a creamy white color. Pkt. 10c., oz. 50c.

CRESS, or PEPPER GRASS

One ounce will sow 100 feet of drill

A popular salad, which should be sown early in Spring—very thickly in shallow drills—and at short intervals, for succession, as it soon runs to seed.

Extra Curled. The best variety grown; leaves are beautifully cut and curled; highly prized for garnishing. Pkt. 10c., oz. 20c., ¼ lb. 50c., lb. \$1.50.

Water. This wholesome salad may be grown in any moist situation. Plants should be set not less than a foot apart. The Cress is fit for gathering the second year. Pkt. 10c., oz. 75c.

COLLARDS

Georgia, Southern, or Creole. This vegetable develops a loose-leaved head. It grows 2 or 3 feet high and produces large, light green leaves on rather long stems. A frost, if not too severe, will improve the crop. Pkt. 10c., oz. 25c., ¼ lb. 75c., lb. \$2.00.

CORN, Sweet, or Sugar

One quart will plant 200 hills; ten quarts will plant one acre in hills

We furnish 15c. packets of all varieties of Sweet Corn free of postage by mail. For other quantities and Parcel Post rate if to go by mail. One quart weighs about 2 pounds.

Corn requires a mellow, loamy, well pulverized soil, and frequent hoeings. Plant in hills 3 feet apart each way, dropping five or six kernels in each hill, or plant in rows 3 to 4 feet apart, and thin the plants out to 8 or 9 inches in the row. From the beginning of May until the middle of July successive plantings can be made every two or three weeks, and by properly selecting the varieties a continued supply can be had until frost kills the plants.

Bantam Evergreen Corn. A yellow variety maturing about 10 days after the Golden Bantam and a week earlier than the Stowell's Evergreen white. It has an ear three times the size of Golden Bantam. Pt. 30c., qt. 50c., pk. \$3.25.

Corn, Field and Fodder. See page 25.

Country Gentleman. Cob small, with deep kernels of pearly whiteness; quality delicious. Pt. 30c., qt. 50c., pk. \$3.25.

Early Crosby. A popular variety; early, good size and quick growth; white kernels and one of the best. Pt. 30c., qt. 50c., pk. \$3.25.

Early Golden Improved. Sweet, tender and delicious. Ears large, 10- to 12-rowed, rich golden yellow color. New England grown. Pt. 30c., qt. 50c., pk. \$3.25.

Golden Bantam. Early, sweet and tender. Smaller than Early Golden; 8-rowed. A favorite variety. Pt. 30c., qt. 50c., pk. \$3.25.

Golden Giant. With its 12- to 16-rowed ears and deep golden yellow kernels is the most desirable yellow sweet Corn yet introduced. The stalks are short, sturdy and frequently produce two ears. Seed offered this year has been carefully grown in Massachusetts. Pt. 35c., qt. 60c.

Golden Sunshine. The earliest of the Golden Bantam type, maturing a week to 10 days earlier than that variety; more dwarf in habit than Bantam, with ears 6½ in. long, containing 12 rows of broad, yellow, sweet grains; especially desirable for its extreme earliness. Pt. 30c., qt. 50c., pk. \$3.25.

Mayflower, Early. An extra early white variety. Matures one week in advance of White Cory. Growth of stalk 4½ to 5 ft., 8 to 12 rows of kernels; large ear. Pt. 25c., qt. 40c., pk. \$2.50.

Peep-O-Day. This Corn has two valuable points—extraordinary earliness and sweetness. It may be used as an early or late variety with equal success. Pt. 25c., qt. 40c., pk. \$2.50.

Pocahontas. One of the earliest varieties in cultivation; ears large and very productive; of fine quality. Pt. 25c., qt. 40c., pk. \$2.50.

Potter's Excelsior or Squantum. Medium late; grows to a good height and produces medium-sized, 12-rowed ears of excellent quality. The sweetest white Corn. Requires liberal seeding, the germ being delicate. Pt. 25c., qt. 40c., pk. \$2.50.

Spanish Gold. Grows from 5 to 6 ft. high, and produces one or more good sized ears on each stalk. Ripens early and has much of the tenderness and flavor of Golden Bantam. Pt. 30c., qt. 50c.

Stowell's Evergreen Special Strain. The Corn is an earlier type than the old variety, maturing a week earlier and especially adapted for New England. The kernels are long and narrow, 18- to 22-rowed. Pt. 30c., qt. 50c., pk. \$3.25.

Whipple's Yellow Sweet Corn. This is a wonderful early yellow Corn that has proved very profitable to raise for market. This Corn is earlier than Bantam and as large as Evergreen. The ears are very large, 8 to 9 in. long, having 14 to 18 rows of deep kernels. Pt. 30c., qt. 50c., pk. \$3.25.

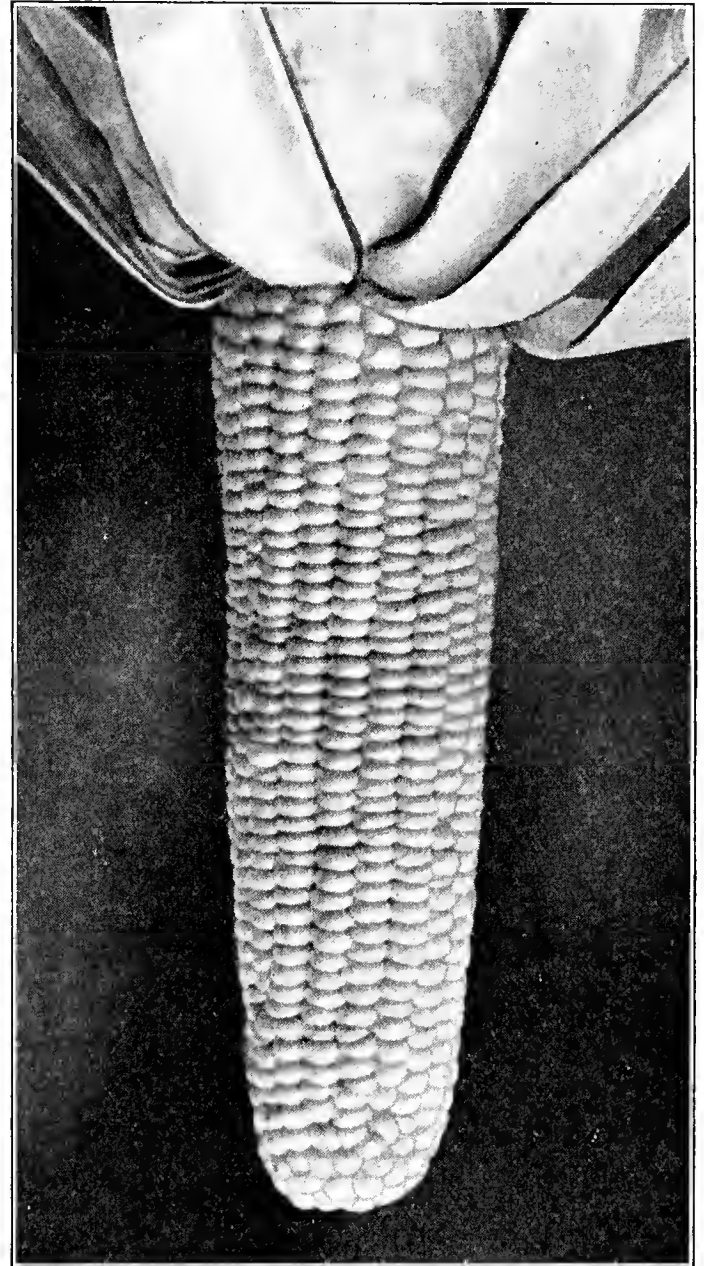

Stowell's Evergreen, Platt's Strain

CORN SALAD or FETTICUS

One ounce will sow 100 feet of drill

This excellent salad may be had the year round. Sow in September, in drills 8 inches apart, covering the seeds lightly and protect from frost by a light covering of hay or litter. The seed may also be sown in Spring.

Large-seeded. The most popular variety grown. Pkt. 10c., oz. 25c., ¼ lb. 75c.

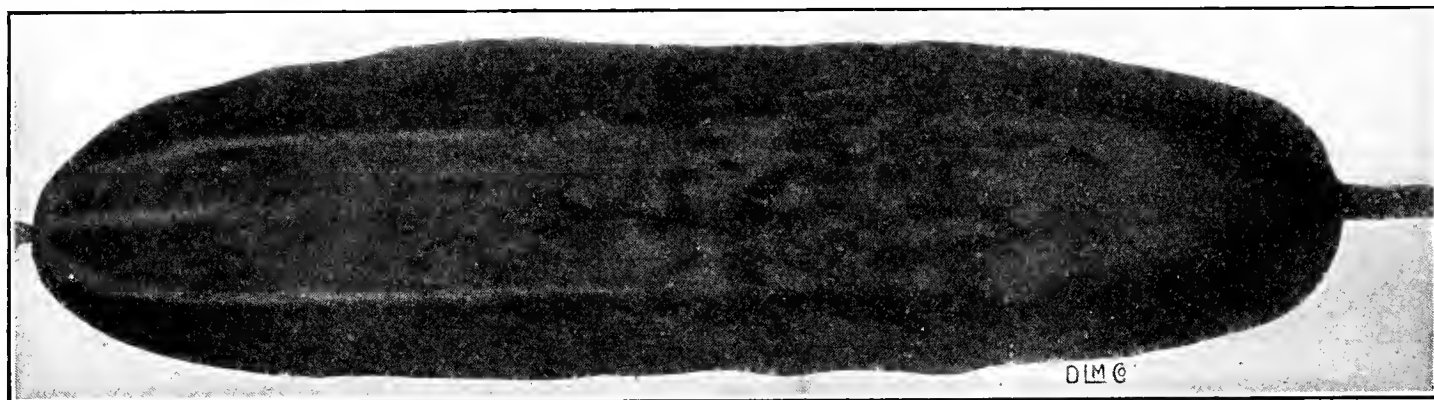

Arlington White Spine

CUCUMBER

One ounce will plant about 50 hills, 1½ lbs. to one acre.

For very early use seed may be started in heat and the plants set out in May. Pieces of inverted sod are an excellent medium for starting and growing early Cucumber plants, as they can be readily lifted from the hotbed to the garden without disturbing the young plants growing upon them. For main crop, plant in hills 4 feet apart, in the end of May. Make the hills rich with well rotted manure, and keep the young plants safe from the striped bug by dusting with plaster, or powdered Hellebore. Leave four strong plants to each hill.

Arlington White Spine. One of the finest Cucumbers for forcing and one of the most perfect in shape, size, color and quality, and is very brittle and crisp. Pkt. 15c., oz. 35c., ¼ lb. \$1.25.

Boston Pickling. The best pickling variety yet introduced; very productive; quick growing, superior color and quality; the most popular variety among the market gardeners. Pkt. 10c., oz. 25c., ¼ lb. 75c.

Davis Perfect. Highly recommended; dark, rich green in color, crisp and tender. Pkt. 10c., oz. 25c., ¼ lb. 75c.

Early Frame, or Short Green. Medium size, very early and good for pickling and slicing. Pkt. 10c., oz. 20c., ¼ lb. 60c.

Fordhook Famous. Largest of the White Spine family; fruit long, thick, and tapering at both ends, crisp and solid; a fine slicing sort; color light green. Pkt. 10c., oz. 25c., ¼ lb. 75c.

Grey's A-1. This variety, unlike most other sorts, succeeds equally well in the garden or in the greenhouse; the vines are exceptionally healthy and productive. The fruits will average 12 to 14 inches in length by 2½ inches in diameter and are very symmetrical; the color a very dark green. Pkt. 50c., oz. \$3.50.

Improved White Spine. The best variety for table use or for market; retains its color a long time after being picked; very productive. Pkt. 10c., oz. 25c., ¼ lb. 75c.

Japanese Climbing. Fruit about 10 inches long; thick and of fine flavor. Skin dark green, flesh pure white; can be grown on trellises and fences. Pkt. 10c., oz. 25c., ¼ lb. 75c.

Long Green. Prickly; firm, crisp, dark green; excellent table variety. Pkt. 10c., oz. 25c., ¼ lb. 75c.



Early Frame, or Short Green

West India Gherkin. Used for pickling purposes; a small, oval-shape variety; has the appearance of a bur. Pkt. 10c., oz. 25c., ¼ lb. 75c.

Woodruff's Hybrid. One of the best of the White Spines for market. Grows 8 to 10 inches long and stays green a long time. We have a very fine strain of this Cucumber. Pkt. 10c., oz. 25c., ¼ lb. 75c.

English Frame Varieties

The following are excellent varieties for growing in forcing houses.

Delicacy (Sutton's). Fruits dark green, slightly ribbed; ideal form and fine flavor. Pkt. 50c.

Every-day (Sutton's). Fruits of good length, color deep green, almost smooth. Pkt. 50c.

King George (Sutton's). Fruits are unusually handsome and perfect in form. Pkt. 50c.

Matchless (Sutton's). Fruits smooth, dark in color and of the highest quality. Pkt. 50c.

Rochford's Market. A well-known variety, heavy cropper. Pkt. 50c.

Satisfaction (Sutton's). Fruit large, straight, dark green, flavor excellent. Pkt. 50c.

Telegraph Improved (Sutton's). Fruit handsome with very small neck; very prolific. Pkt. 50c.

Tender and True. A well known variety, heavy cropper. Pkt. 50c.

DANDELION

One ounce will sow 200 feet of drill; 2 lbs. will sow an acre

Sow seed in May or June, in drills ½ inch deep and 15 inches apart. Thin the plants to stand 4 inches apart, cultivate during the Summer to keep down weeds. Dandelion may be blanched like Endive for salad purposes, or it may be sown later in the season. Plant—cover lightly with salt hay, and the following Spring they will be fit for use as early greens, and considered one of the earliest and most healthful Spring greens or salads.

American Improved. The finest variety, leaves very numerous, thick in texture and blanch readily. Pkt. 25c., oz. \$1.50, ¼ lb. \$5.00.

French Thick Leaf. Unsurpassed in thickness of leaf and deep green color. Pkt. 25c., oz. \$1.50, ¼ lb. \$5.00.

EGGPLANT

One ounce will produce 1000 plants

Sow in hotbeds very early in Spring, and transplant when two inches high into a second bed or into small pots. If that is not done, thin to 4 inches apart. Do not plant out till the weather becomes perfectly settled and warm. Keep plants watered for a few days if the sun is hot when put out. Set out plants 3 feet by 2.

Black Beauty. Very early and as large as New York Improved. Rich purplish black color. Pkt. 10c., oz. 75c.

Black Pekin. Fruit globular, almost black in color, fine grained and delicately flavored. Pkt. 10c., oz. 75c.

Early Long Purple. A very early, hardy and productive variety of good quality. Pkt. 10c., oz. 75c.

New York Improved. A leading market variety; fruit large, oval, very productive. Pkt. 10c., oz. 75c.

ENDIVE

One ounce will sow 150 feet of drill

A rather moist soil is preferred. Sow early in the Spring in drills, 12 inches apart, and thin out the plants to 10 inches apart in the drills as soon as they are large enough to handle.

Broad-leaved Batavian. Leaves broad; light green, and require to be tied up for blanching. Pkt. 10c., oz. 35c., $\frac{1}{4}$ lb. \$1.00.

Green Curled. A very hardy dark green, closely curled variety, tender and crisp. Pkt. 10c., oz. 35c., $\frac{1}{4}$ lb. \$1.00.

Moss Curled. Beautifully curled, and when well developed resembles a tuft of moss. Pkt. 10c., oz. 35c., $\frac{1}{4}$ lb. \$1.00.

Witloof. See **Chicory**, page 7.

FENNEL, Florence, or Naples

(Finocchio di Napoli)

Sow in Spring in rows 16 to 20 inches apart and thin to 5 or 6 inches apart. Water freely. Pkt. 10c., oz. 50c.

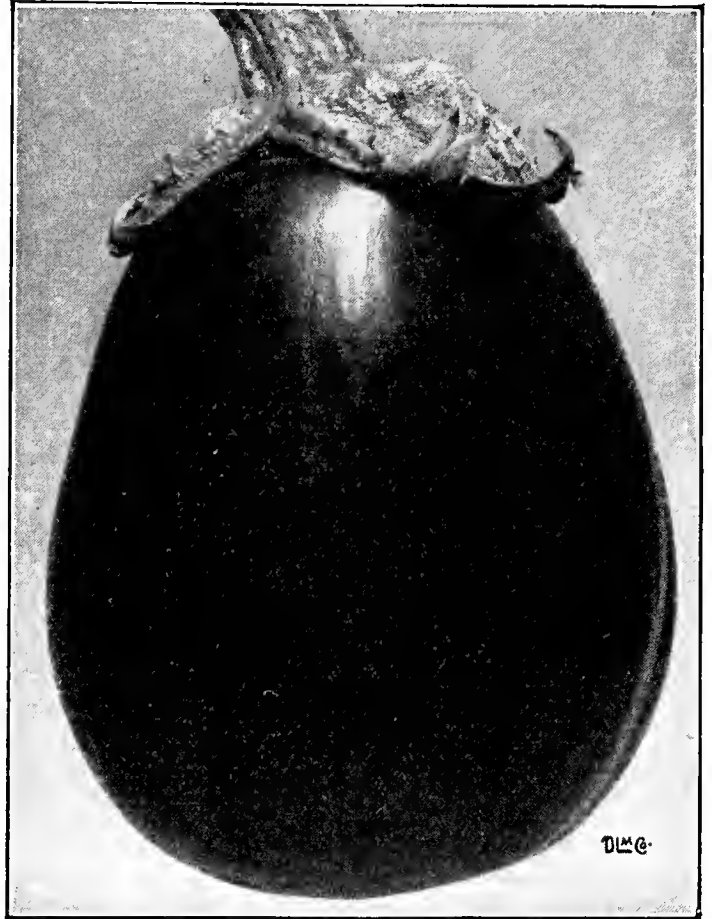
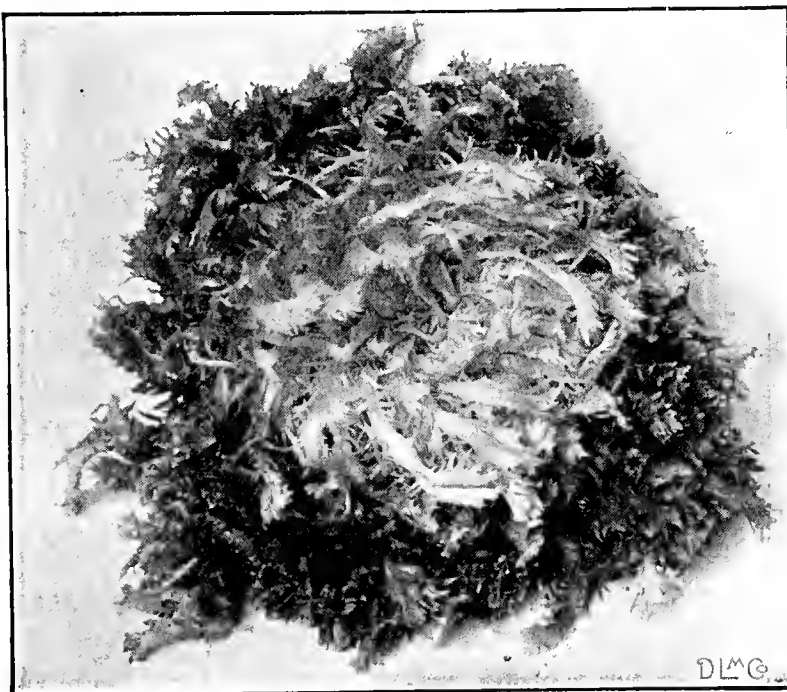

GARLIC

The bulbs are set out like Onion sets, about 4 inches apart in the row, divided into "cloves" or flakes and covered 2 inches deep. Lb. 60c.

HORSERADISH SETS

Maliner Kren. A variety producing very large, pure white roots. Strong sets. Doz. 35c., 100 \$1.75.

KALE, or BORECOLE

One ounce will produce 1500 plants

Early plants may be started in the hotbed, or the seeds may be sown in the open ground in April or May; transplant in June, into rows, and cultivate the same as Cabbage. Sea Kale should be blanched either under large pots or by banking up with sand.

Dwarf Green Curled. One of the best; very hardy and improved by a moderate frost. Pkt. 10c., oz. 25c., $\frac{1}{4}$ lb. 75c.

Sea Kale. Pkt. 20c., oz. \$1.00.

Winter, or Siberian Greens (Sprouts). Sow in August or early in September in rows 1 foot apart. Pkt. 10c., oz. 25c., $\frac{1}{4}$ lb. 75c.

KOHL-RABI

One ounce will sow 200 feet of drill

The seed may be sown in June in rows 18 inches apart, and the plants thinned out to 8 or 10 inches.

Purple Vienna. Similar to the following, except in color. Pkt. 10c., oz. 50c., $\frac{1}{4}$ lb. \$1.50.

White Vienna. The earliest and best table or market variety. Pkt. 10c., oz. 50c., $\frac{1}{4}$ lb. \$1.50.



Lettuce, Improved Big Boston

LETTUCE

One ounce will produce about 3000 plants

Lettuce succeeds best in rich and comparatively moist soil and is most crisp and tender if grown in cool, moist weather. The more rapidly the plants are grown, the more tender and brittle will be their quality. For early use, sow under glass in February or March, and transplant into a previously prepared hotbed; rows at least 12 inches apart, according to the varieties. Sowing may be made in the open ground as soon as all danger from frost is over; if a continuous supply is desired during season, make sowing every two or three weeks until September.

All the Year Round. A valuable variety, with compact, close heads. Pkt. 10c., oz. 40c., $\frac{1}{4}$ lb. \$1.25.

Big Boston. A most desirable variety either for forcing or open ground planting. Pkt. 10c., oz. 40c., $\frac{1}{4}$ lb. \$1.25.

Boston Curled. A variety highly esteemed for earliness and beauty of form. Pkt. 10c., oz. 40c., $\frac{1}{4}$ lb. \$1.25.

Black Seeded Mammoth Butter. The largest and considered by many the best variety for the late crop. Produces enormous formed heads of the finest quality. Pkt. 10c., oz. 40c., $\frac{1}{4}$ lb. \$1.25.

Deacon. Splendid variety for standing Summer heat; large, solid heads, tender, crisp and sweet. Pkt. 10c., oz. 40c., $\frac{1}{4}$ lb. \$1.25.

French, Unrivaled. Suitable for growing at any season. A sure heading variety, forming large, compact heads, and slow to run to seed. Similar to Big Boston, being lighter green in color and not tinged with brown. Pkt. 10c., oz. 40c., $\frac{1}{4}$ lb. \$1.25.

Giant Crystal Head. Outside leaves curled, with red edges. Heads large and solid. Pkt. 10c., oz. 40c., $\frac{1}{4}$ lb. \$1.25.

Grand Rapids. Crisp and tender, fine for forcing or outdoor culture. Pkt. 10c., oz. 40c., $\frac{1}{4}$ lb. \$1.25.

Hanson Improved. A superior, curled heading variety of large size, sweet, tender and crisp. Pkt. 10c., oz. 40c., $\frac{1}{4}$ lb. \$1.25.

Iceberg. A solid heading large variety of excellent quality. Pkt. 15c., oz. 75c., $\frac{1}{4}$ lb. \$2.25.

May King. Grows quickly and produces globe-shaped heads which are ten to fourteen days earlier than any other, and which stand a long time before going to seed. Pkt. 10c., oz. 40c., $\frac{1}{4}$ lb. \$1.25.

May King. Selected Strain. As a Lettuce for greenhouse forcing, this is the best; heads form very quickly, are firm and of fine quality. Pkt. 15c., oz. 75c., $\frac{1}{4}$ lb. \$2.25.

Mignonette. Very solid and compact and of a distinct russet color. Pkt. 10c., oz. 40c., $\frac{1}{4}$ lb. \$1.25.

Prize Head. Large, loose heads, tinged with brown. Pkt. 10c., oz. 40c., $\frac{1}{4}$ lb. \$1.25.

Salamander. Fine compact heads which resist Summer heat admirably. Pkt. 10c., oz. 40c., $\frac{1}{4}$ lb. \$1.25.

Simpson Black Seeded. Leaves delicate golden yellow; a superior variety either for forcing or sowing out of doors. Pkt. 10c., oz. 40c., $\frac{1}{4}$ lb. \$1.25.

Simpson Early Curled. Early variety; good for forcing or open ground. Pkt. 10c., oz. 40c., $\frac{1}{4}$ lb. \$1.25.

Sutton's Supreme. A fine Lettuce of the Drumhead type, and a marked advance on other varieties of the same class. Attains a large size, with a firm heart, which remains good for a long time before starting seed stems. Leaves prettily edged with red. Pkt. 25c.

Tennis Ball, Black Seeded, Select Strain. A very popular sort for open ground culture; forms a handsome head and is crisp and tender. Pkt. 15c., oz. 75c., $\frac{1}{4}$ lb. \$2.50.

Tennis Ball, White Seeded. Extensively grown for forcing and heading under glass; heads firm and good size, very white and crisp. Pkt. 10c., oz. 40c., $\frac{1}{4}$ lb. \$1.25.

Tom Thumb. A splendid variety for hotbeds and pot culture; compact heads and crisp. Pkt. 10c., oz. 40c., $\frac{1}{4}$ lb. \$1.25.

"Wayahead." Very early, with large, tightly folded heads; the outer leaves are light green, with the inner head finely blanched to a rich buttery yellow. Pkt. 10c., oz. 40c., $\frac{1}{4}$ lb. \$1.25.

White Boston. A sure, hard-heading variety, the heart and inner leaves are a rich yellow. It is deliciously flavored, very tender, of splendid quality. Pkt. 10c., oz. 40c.

Wonderful, or New York Cabbage. One of the largest varieties. Wonderful heat resister; strong grower. Heads solid, crisp and tender. Pkt. 10c., oz. 40c., $\frac{1}{4}$ lb. \$1.25.

Romaine, or Cos Varieties

Sutton's Little Gem Cos. An entirely distinct Cos Lettuce, and a most valuable dwarf, compact variety. Dark green, small, solid, crisp, slow in running to seed, and of delicious quality. Pkt. 25c., $\frac{1}{2}$ oz. 60c., oz. \$1.00.

Trianon Self-Closing Cos. The finest of the Cos varieties. Leaves long, narrow and erect. Pkt. 10c., oz. 40c., $\frac{1}{4}$ lb. \$1.25.



Lettuce, Cos or Romaine

LEEK

One ounce will sow 100 feet of drill.

Sow as early in Spring as practicable, in drills 1 inch deep and 1 foot apart. When 6 or 8 inches high, transplant in rows 10 inches apart each way, setting them deep, that the neck, being covered may be blanched.

Musselburgh, or Scotch. A very large variety of superior quality. Pkt. 10c., oz. 40c., $\frac{1}{4}$ lb. \$1.25.

Giant Carantan. Large size and extra fine quality. Pkt. 10c., oz. 40c., $\frac{1}{4}$ lb. \$1.25.

Large Flag Winter. Desirable for market or family use. Pkt. 10c., oz. 40c., $\frac{1}{4}$ lb. \$1.25.

Large Rouen. Grows to a large size and keeps well. Pkt. 10c., oz. 40c., $\frac{1}{4}$ lb. \$1.25.

MARTYNIA

One ounce will plant 100 hills

Sow in the open ground in May, and thin out the plants to 2 or 3 feet apart, or a few seeds may be sown in a hotbed and afterward transplanted.

Proboscidea. Pkt. 10c., oz. 50c.

MUSKMELON

One ounce will plant 60 hills, two to three pounds for an acre.

Plant in May, six to eight seeds to the hill, and when the plants are well up, thin out to three. Cultivate until the vines cover the ground, and pinch the ends of the growing shoots to induce early fruiting.

Green and Yellow-Fleshed Varieties

Arlington Nutmeg. Deep green, finely netted, flesh greenish yellow; rich and sugary. Pkt. 10c., oz. 25c., $\frac{1}{4}$ lb. 75c.

Bay View. Largest, most prolific, best flavored, finest Cantaloupe in cultivation. Pkt. 10c., oz. 25c., $\frac{1}{4}$ lb. 75c.

Extra Early Hackensack. Large size, round shape, deeply ribbed, roughly netted; flesh green, very sweet, and highly flavored. Pkt. 10c., oz. 25c., $\frac{1}{4}$ lb. 75c.

Honey Ball. Very productive; fruits globular; 5 in. diameter; yellowish white; smooth; sparsely netted. Flesh silvery green, juicy, with sweet honeylike flavor. Pkt. 10c., oz. 25c., $\frac{1}{4}$ lb. 75c.

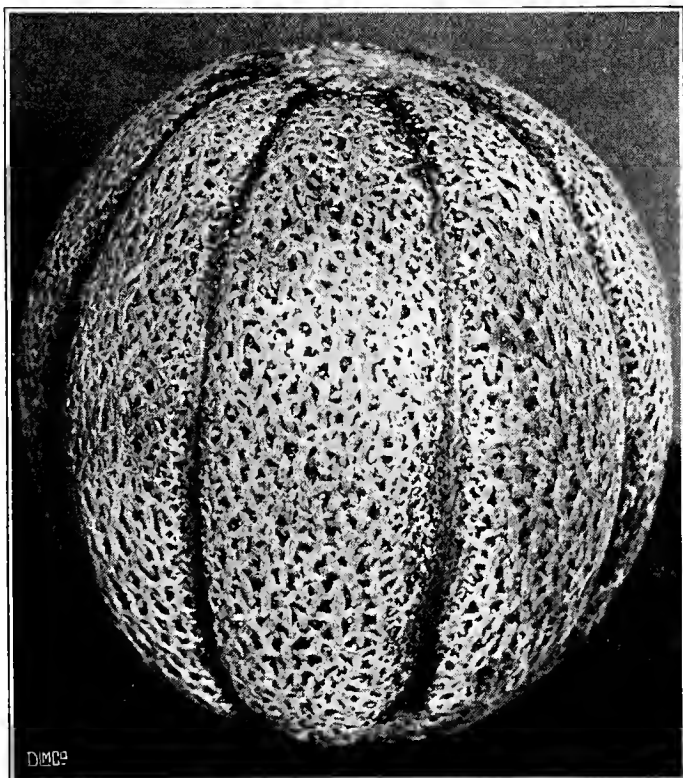

Rocky Ford Melon

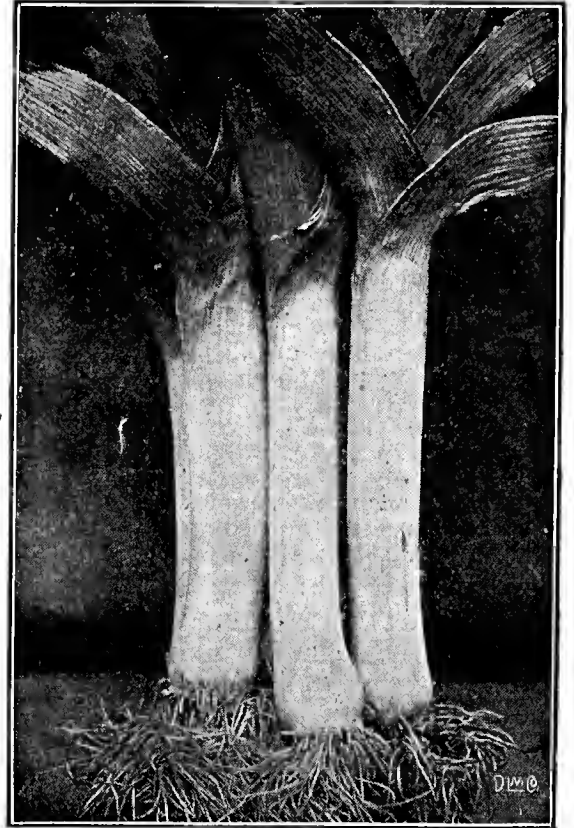

Miller's Cream. Nearly round, light green netted skin, with yellow flesh. Quality good. Pkt. 10c., oz. 25c., $\frac{1}{4}$ lb. 75c.

Rocky Ford. One of the best varieties. Flesh thick and green; sweet and luscious. Pkt. 10c., oz. 25c., $\frac{1}{4}$ lb. 75c.

Red, or Salmon-Fleshed Varieties

Bender's Surprise. It is medium early with deep orange flesh, which is very thick and deliciously sweet. Pkt. 10c., oz. 25c., $\frac{1}{4}$ lb. 75c.

Emerald Gem. Small, extra early; smooth ribbed dark green skin and orange flesh; sweet. Pkt. 10c., oz. 25c., $\frac{1}{4}$ lb. 75c.

Hale's Best. An early variety, flesh is very thick and fine grained, deep salmon pink in color and richly flavored. Pkt. 10c., oz. 25c., $\frac{1}{4}$ lb. 75c.

Hearts of Gold. A splendid small, midseason variety. Flesh very thick, deep salmon color, and of high quality. A good shipping Melon. Pkt. 10c., oz. 25c., $\frac{1}{4}$ lb. 75c.

Lake Champlain (Golden Champlain). An exceedingly early salmon-fleshed Melon of medium size and fine quality. Pkt. 10c., oz. 50c., $\frac{1}{4}$ lb. \$1.50.

Oka. A Montreal Melon originated by a Canadian horticulturist, is the result of several years selection of the Montreal Market crossed with a red-fleshed variety, sweet and juicy. The color is a beautiful cream, with a bright salmon flesh. Pkt. 25c.

MUSKMELONS FOR FORCING

Blenheim Orange. Handsome scarlet flesh, superb flavor. Pkt. 50c.

Cotting's Hybrids. Flesh orange, oval shaped, delicious flavor. Pkt. 50c.

Hero of Lockinge. Fruit handsome, flesh white, extremely rich in flavor. Pkt. 50c.

King George. Scarlet flesh, yellow skin, large, luscious fruits. Pkt. 50c.

Superlative. Flavor exceptionally fine, scarlet flesh, round fruits; very productive. Pkt. 50c.

Sutton's A-1. Rich scarlet flesh, large globular fruits; fine flavor. Pkt. 50c.

Sutton's Universal. Fruits large, flesh is white and very thick; flavor exceptionally fine. Pkt. 50c.

WATERMELON

One ounce will plant 30 hills. Four pounds will plant one acre.

Cultivate in the same manner as Muskmelons, but plant 8 to 10 feet apart.

Cole's Early. Very early variety; flesh very deep and sweet; color light green striped. Pkt. 10c., oz. 20c., $\frac{1}{4}$ lb. 50c.

Colorado Preserving. This is more productive than the common preserving Citron, and larger; the flesh is firm and solid. Pkt. 10c., oz. 20c., $\frac{1}{4}$ lb. 50c.

Cuban Queen. Beautifully striped, dark and light green; vigorous in growth; flesh bright red, solid, luscious, crisp and sugary. Pkt. 10c., oz. 20c., $\frac{1}{4}$ lb. 50c.

Early Fordhook. Extra early, good size, green skin, red flesh. Pkt. 10c., oz. 20c., $\frac{1}{4}$ lb. 50c.

Halbert Honey. Dark green skin; flesh crimson, luscious and sweet. Vigorous grower. Pkt. 10c., oz. 20c., $\frac{1}{4}$ lb. 50c.

Kleckley Sweets. Exceedingly sweet and fine flavored. Scarlet flesh. Pkt. 10c., oz. 20c., $\frac{1}{4}$ lb. 50c.

Ice Cream. Fruit round, of medium size; skin pale green; flesh scarlet, crisp and delicious. Pkt. 10c., oz. 20c., $\frac{1}{4}$ lb. 50c.

Mountain Sweet. One of the best for general culture; color dark green, rind thin, flesh scarlet, solid, very sweet and delicious. Pkt. 10c., oz. 20c., $\frac{1}{4}$ lb. 50c.

Phinney's Early. An early variety, of medium size; red fleshed, quite hardy, and very productive; quality excellent. Pkt. 10c., oz. 20c., $\frac{1}{4}$ lb. 50c.

Tom Watson. The flesh is rich red color. Solid sweet and luscious. and ripens close up to the rind. Pkt. 10c., oz. 20c., $\frac{1}{4}$ lb. 50c.

Vick's Early. Very early, oblong, medium size, with bright pink flesh, solid and sweet. Pkt. 10c., oz. 20c., $\frac{1}{4}$ lb. 50c.

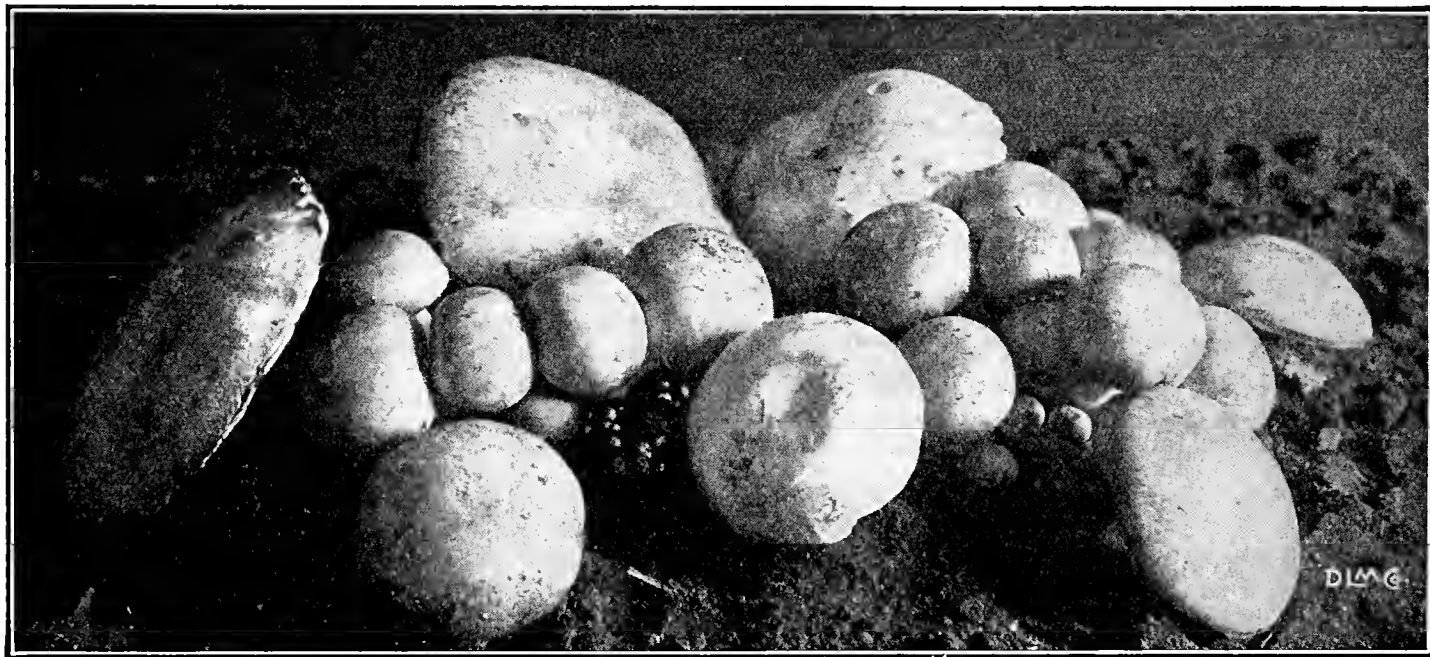

MUSHROOM

One pound of spawn is sufficient for nine square feet of bed.

Mushrooms are more easily cultivated than many people imagine, and may be grown in any dark room or cellar where the temperature can be maintained at from fifty to sixty-five degrees. For the bed, use a mixture of horse manure and good fresh loam in equal proportions. Before being placed in the bed let this material be thoroughly mixed, and well turned three or four times to sweeten in some dry place. Upon a dry, firm bottom, proceed to make the bed, by spreading a thin layer of the prepared mixture and pound it firm till the bed is eight inches thick. Leave it thus for about a week, or till the temperature of the bed has subsided to ninety or ninety-five degrees. Then make holes about 10 inches apart, and put in each a piece of spawn about the size of an egg. Cover the holes and press the soil solid and smooth. Let the bed remain in this condition ten days. Then cover with 2 inches of fresh loam. Over this place a few inches of straw. If the temperature is right, Mushrooms will appear in six to eight weeks from time of spawning. The bed will continue bearing about a month. After the first crop is gathered, spread over the bed an inch of fresh loam, and moisten with warm water. In the event of the surface of the bed getting very dry at any time, it should be moistened freely with water at a temperature of eighty to eighty-five degrees.

If wanted by mail, add postage at parcel post rates.

American Pure Culture. Single bricks 30c. each, 20 bricks \$5.00.

American Pure Culture. New mammoth strain. Single bricks, 40c. each, 20 bricks, \$7.00.

MUSTARD

One ounce will sow 50 feet of drill.

Green mustard imparts a delightfully pungent flavor to the various forms of prepared salads. For early crops the seed may be sown in a hotbed in March, and for general crop at frequent intervals through the Spring, in drills from 8 to 12 inches apart.

Chinese Broad-leaved. Leaves much larger than the white Mustard. Flavor pleasantly sweet and pungent. Can be cooked like Spinach. Pkt. 10c., oz. 25c., ¼ lb. 75c., lb. \$2.00.

Fordhook Fancy. Very ornamental. Plants of vigorous growth; cooked same as Spinach. Pkt. 10c., oz. 25c., ¼ lb. 75c.

White. Much used for salads; the seed is also used medicinally, and as a seasoning for pickles. Pkt. 10c., oz. 25c., ¼ lb. 75c., lb. \$2.00.

OKRA, or GUMBO

One ounce will sow 40 feet of drill.

This plant is extensively cultivated for its green pods, which are used in soups and stews, and are very wholesome and nutritious. Sow about the middle of May, in drills 3 feet apart, and thin out the plants to 1 foot apart.

Improved Dwarf Green. Very early; smooth pods. Pkt. 10c., oz. 25c., ¼ lb. 75c.

White Velvet, or Creole. Pods smooth, of large size, and a creamy white. Pkt. 10c., oz. 25c., ¼ lb. 75c.

“HERBICIDE” THE WEED EXTERMINATOR

ONION

One ounce will sow 100 feet of drill. Four or five pounds to the acre.

The Onion thrives best in light, loamy, mellow soil; and, unlike most kinds of garden vegetables, succeeds well when cultivated on the same land for successive years. The seed should be sown as early in the Spring as the ground is in good working condition, in drills 14 inches apart, and covered ¼ inch deep. Keep free from weeds, but be careful not to disturb the growing bulbs. A top dressing of wood ashes, applied after the second weeding, is very beneficial. The Onions will ripen early in September, and after being gathered and exposed to the sun for a few days for drying, they will be ready for storing or the market.

Ailsa Craig. Grows to a large size; very mild flavor; pale yellow. A valuable exhibition variety. Pkt. 25c., oz. \$1.00, ¼ lb. \$3.50.

Barletta. A very early, small, pure white variety, flesh firm and mild in flavor. Excellent for pickling. Pkt. 15c., oz. 60c., ¼ lb. \$2.00.

Cranston's Excelsior. Handsome globe-shaped variety; large, solid, with small neck; straw color. An exhibition variety. Pkt. 25c., oz. \$1.00.

Danvers Yellow Globe. Selected with the greatest care; the true shape and color; a reliable and sure cropper. Pkt. 10c., oz. 50c., ¼ lb. \$1.50.

Danvers Yellow Globe. Selected Strain. The finest type of this popular variety on the market. Pkt. 25c., oz. \$1.00, ¼ lb. \$3.00.

Early Red Globe. Of beautiful shape; splendid quality and an excellent keeper. Pkt. 10c., oz. 50c., ¼ lb. \$1.50.

Giant White Italian Tripoli. An excellent, large, white Italian variety; of quick growth, mild and pleasant flavor. Pkt. 10c., oz. 50c., ¼ lb. \$1.50.

Gigantic Gibraltar. A handsome straw-colored Onion of enormous size, possessed of many sterling qualities. Grand for exhibition. Pkt. 25c., oz. \$1.00.

Large Red Wethersfield. The leading red variety of the East; almost round; deep red color; grows to good size and is a good keeper. Pkt. 10c., oz. 50c., ¼ lb. \$1.50.

Mammoth Silver King. Of attractive shape, with silvery white skin and flesh of a most agreeable mild flavor. Pkt. 10c., oz. 50c., ¼ lb. \$1.50.

Prizetaker. Of a rich straw color and enormous size, averaging 12 to 14 inches in circumference. Although of such great size, it is very hard and an excellent keeper. Pkt. 10c., oz. 50c., ¼ lb. \$1.50.

Southport Red Globe. A good late sort. Keeps well. Pkt. 10c., Oz. 50c., ¼ lb. \$1.50.

Southport Yellow Globe. A fine large variety. Somewhat later than the Danvers. Pkt. 10c., oz. 50c., ¼ lb. \$1.50.

Sweet Spanish. A handsome globe-shaped Onion of the largest size, skin light yellow, flesh white and very mild. Eating and keeping qualities excellent. Pkt. 10c., oz. 50c., ¼ lb. \$1.50.

The Queen. A handsome silver-skinned variety; esteemed for its rapid growth, mild flavor and fine keeping qualities. Pkt. 10c., oz. 50c., ¼ lb. \$1.50.

White Globe. Of mild flavor; good keeper. One of the best. Pkt. 10c., oz. 50c., ¼ lb. \$1.50.

White Portugal, or Silver Skin. Bulbs of medium size; flattened; skin silvery white; flesh fine grained and mild flavored. Pkt. 10c., oz. 50c., ¼ lb. \$1.50.

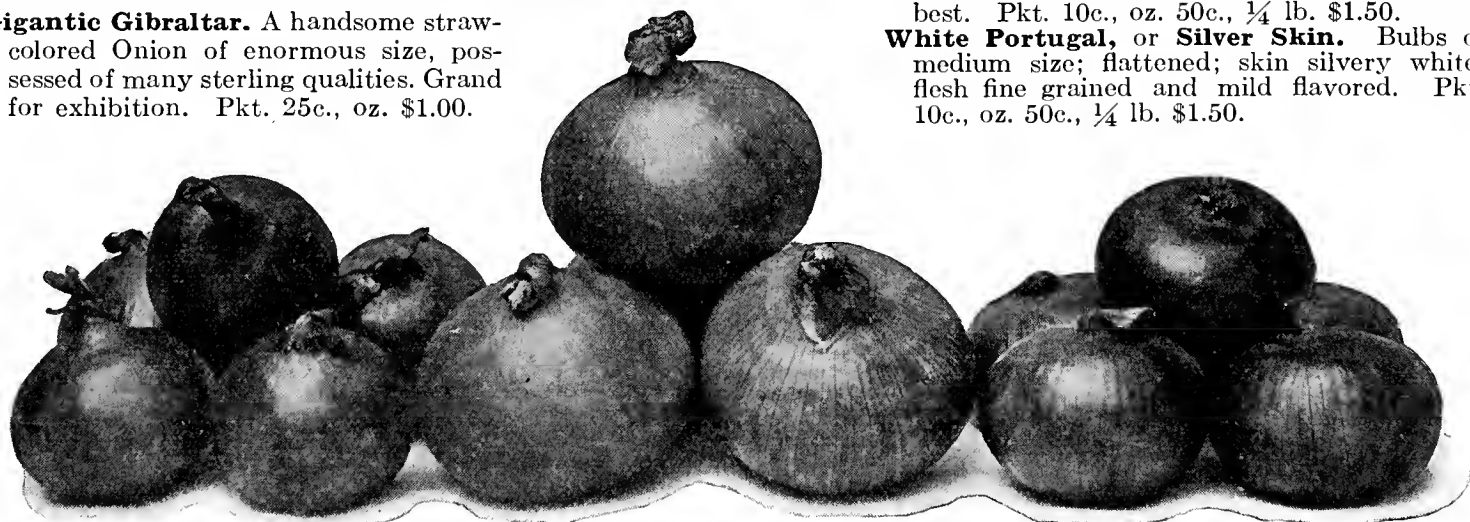

Southport Red Globe

Danvers Yellow Globe

Red Wethersfield

ONION SETS

Prices Variable

These are small Onions grown the previous year, ripened off and taken up when mere bulblets. They produce a very early crop, and grow in any good soil. Set them 3 or 4 inches apart in rows 1 foot apart. Potato Onions are generally grown from bulbs grown in clusters which are separated when planted.

If ordered by mail, add postage.

Shallots. Much used in soups, salads, etc. Qt. 50c., 4 qts. \$1.75, pk. \$3.25.

Japanese Yellow Onion Sets. The best variety of yellow sets for earliness, quality and production. Qt. 40c., 4 qts. \$1.40, pk. \$2.75.

Potato Onions, White (Multipliers). Very productive and early and keep remarkably well. Qt. 50c.

Potato Onions, Yellow. A little earlier than the white and yellow sets. Qt. 50c., pk. \$3.25.

White Sets. The best for general use, early, and of fine flavor. Qt. 40c., 4 qts. \$1.40, pk. \$2.75.

Yellow Sets. Preferred by some to white sets. Qt. 40c., 4 qts. \$1.40, pk. \$2.75.

PARSNIP

One ounce will sow 100 feet of drill. Five to six pounds to the acre

Sow in April or early in May, as Parsnips require a long season to mature. Their cultivation is otherwise the same as directed for Carrots. If left in the ground till the following Spring, they are very much improved in flavor.

Arlington Long White. A good variety for general use; long and smooth. Pkt. 10c., oz. 25c., $\frac{1}{4}$ lb. 75c.

Early Round. The earliest variety in cultivation, of good flavor but of small size. Pkt. 10c., oz. 30c., $\frac{1}{4}$ lb. \$1.00.

Hollow-Crowned. Roots very long, white, smooth and sweet. Excellent flavor. Pkt. 10c., oz. 25c., $\frac{1}{4}$ lb. 75c.

Student. A favorite English variety; tender and smooth. Pkt. 10c., oz. 30c., $\frac{1}{4}$ lb. \$1.00.

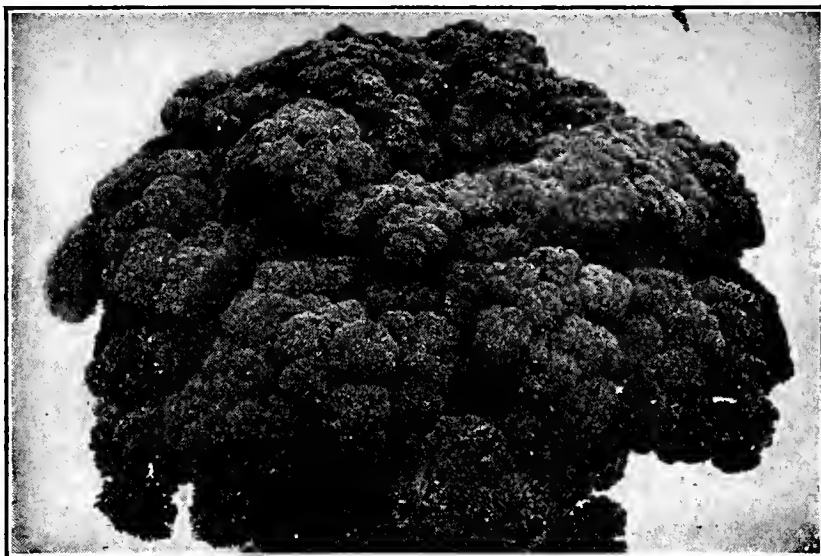

Grey's Perfection

PARSLEY

One ounce will sow 150 feet of drill.

Parsley succeeds best in rich, mellow soil, and as the seed germinates slowly—sometimes remaining in the earth four or five weeks before the plants appear—the sowing should be made as early in Spring as the ground is in working condition. Can also be sown in hotbed in February. When the plants are 2 or 3 inches high, thin them out to 8 or 10 inches apart. The leaves of the curled varieties are used for garnishing, also for flavoring soups and stews.

Double Curled. Dwarf, finely curled; excellent for table and edgings. Pkt. 10c., oz. 25c., $\frac{1}{4}$ lb. 75c.

Dobbie's Exhibition. This Parsley has long been recognized as a standard exhibition sort. It is remarkable for its large, fine leaves and close habit. The seed offered has been saved from selected plants only; every one was a perfect specimen. Pkt. 25c., oz. 75c.

Fern-leaved. Resembles crested fern or moss; grand for table decoration. Pkt. 10c., oz. 25c., $\frac{1}{4}$ lb. 75c.

Grey's Perfection. Beautifully curled and highly ornamental. Pkt. 25c., oz. 75c.

Hamburg, or Rooted. The roots are used for flavoring. Pkt. 10c., oz. 30c., $\frac{1}{4}$ lb. \$1.00.

Moss Curled. One of the finest varieties for garnishing on account of its mossy appearance and its bright color. Pkt. 10c., oz. 25c., $\frac{1}{4}$ lb. 75c.



Hollow-Crowned

PEAS

One quart will sow 100 feet of drill. One and one-half bushels per acre.

Peas succeed best in light, rich soil; dwarf varieties require liberal manuring, the tall varieties requiring less; they also succeed best under a low temperature. The early round, smooth varieties should be planted as early in Spring as possible, while the wrinkled sorts, which are more tender, will do better if planted after the ground becomes warmer. Sow in drills, 2 to 3 feet apart, according to variety, and cover early sowings about 2 inches; later plantings should be covered 3 to 4 inches. Make the drills deep enough to allow room for the manure, which should be scattered along the bottom of the drill and then covered thinly with soil before sowing the Peas, so that they will not come in contact with it. Successive plantings can be made every ten days up to the middle of July. For the later plantings the early varieties are preferred.

If ordered to go by mail, add Parcel Post rate to cover postage. We furnish 20c. packages of all kinds of Peas, except where noted, free postage. One quart weighs about 2 pounds.

Early Varieties

Alaska, or Clipper. A superior blue-seeded variety, very early and productive. A valuable variety either for private use or for market. Pods well filled. 2½ feet. Pt. 30c., qt. 50c., 4 qts. \$1.50.

Blue Bantam. A fine extra early, wrinkled Pea. Large pods well filled with deep green, fine flavored Peas. Height 2¼ ft. Pt. 40c., qt. 75c., 4 qts. \$2.25.

Early Bird. A splendid early variety. This Pea matures as early as Laxtonian; seed blue, semi-wrinkled. Pods large and well filled. Height 16 inches. Pt. 40c., qt. 75c.

Early Morn. Of Gradus type. Early, with large pods and Peas of good flavor. 3 ft. Pt. 40c., qt. 75c., 4 qts. \$2.25.

Gradus (Prosperity). Large, handsome pods, well filled, ripening with the earliest; pods long, straight, slightly rounded at the point. 3 ft. Pt. 40c., qt. 75c., 4 qts. \$2.25.

Grey's Perfection. One of the earliest Peas in cultivation; the pods, which are numerous, contain six or seven good-sized Peas. Very productive and of fine flavor. 2½ ft. Pt. 40c., qt. 75c., 4 qts. \$2.25.

Hundredfold. A splendid large-podded dwarf variety; the pods are 4 inches long and well filled with large deep green Peas of fine quality. The vines grow 16 to 18 inches high and very strong. This is one of the best dwarf early Peas for the home garden and market. Pt. 40c., qt. 75c., 4 qts. \$2.25.

Laxton's Progress. This is the finest new early dwarf Pea Laxton has ever yet raised; wrinkled, averaging 9 to 10 Peas to a pod. The pods are dark green, height 18 to 24 in. Pt. 40c., qt. 75c.

Laxtonian, Re-Selected. This fine new Pea has been carefully selected, and the stock now offered is saved from deep green, giant pods only. Pods are slightly curved and deep green Peas are of excellent flavor. Pt. 40c., qt. 75c.

Little Marvel. This is one of the best among the dwarf Peas, being a heavy cropper and producing Peas of best quality. Pods green, blunt-ended and well filled. Pt. 40c., qt. 75c., 4 qts. \$2.25.

Nott's Excelsior. An improvement on American Wonder, being more vigorous and prolific, with larger pods and more Peas. Height 15 in. Pt. 30c., qt. 50c., 4 qts. \$1.75.

Pilot. An extra early round-seeded or smooth Pea. Can be planted as soon as ground can be worked. Pods as large as the Gradus. Very prolific, highly recommended as an extra early market sort. Pt. 40c., qt. 75c., 4 qts. \$2.25.

Sutton's Pioneer. A first early Pea which has won great popularity for its many excellent qualities. Height about 2 ft. Pt. 30c., qt. 55c.

Sutton's Excelsior. An extra early, dwarf, wrinkled Pea, fully as early as the American Wonder, with much broader pods, filled with large Peas of the finest flavor. 1½ ft. Pt. 30c., qt. 55c., 4 qts. \$1.75.



Peas, Laxtonian

Thomas Laxton. One of the best early wrinkled Peas yet introduced; very productive, with large, well-filled pods. 3 ft. Pt. 40c., qt. 75c., 4 qts. \$2.25.

World's Record. An earlier strain of the well-known Gradus Peas. The medium green, moderately stout vines, bearing medium green pods, 4 inches long, which are fairly broad, pointed, and well filled with from 7 to 9 very fine dark green Peas of exceptional quality. Pt. 40c., qt. 75c., 4 qts. \$2.25.

Second Early and Late Varieties

Alderman. A large-podded wrinkled Pea of robust habit. Pods 4 to 5 inches long, well filled with Peas of excellent flavor. 3½ ft. Pt. 40c., qt. 75c., 4 qts. \$2.25.

Admiral Beatty. A new and very popular variety, highly productive and of excellent quality. Height 4 feet, pods large, green and produced in pairs. Pt. 40c., qt. 75c.

Canada Field. See page 28.

Champion of England. A standard variety; very sweet and delicious. One of the best and most popular. 5 ft. Pt. 30c., qt. 55c., 4 qts. \$1.75.

Duke of Albany (American Champion). Immense pod on style of Telephone. 3 ft. Pt. 40c., qt. 75c., 4 qts. \$2.25.

PEAS—Continued.

Dwarf Champion. A dwarf form of popular Champion of England with large pods, very productive, finest quality. 2 ft. Pt. 30c., qt. 55c., 4 qts. \$1.75.

Dwarf Telephone or Daisy. Season medium. Pods long, remarkably well filled, color pale green; peas large, tender and of delicious flavor. 1½ ft. Pt. 30c., qt. 55c.

Everbearing Bliss. A continuous bearing variety which gives it especial value for late Summer and Autumn use. Pods 3 to 4 in. long, producing six to eight large, wrinkled peas; quality unsurpassed. 2 ft. Pt. 30c., qt. 55c., 4 qts. \$1.75.

French Canner (Petit Pois). Very prolific, with long, slim, curved pods, containing seven to nine peas. 3 to 3½ ft. Pt. 40c., qt. 75c., 4 qts. \$2.25.

Mammoth Melting Sugar. Best of all the edible-podded Peas. Pods straight, smooth, brittle and delicious. 3 ft. Pt. 50c., qt. 90c.

Sutton's Super V. C. The largest podded Pea in existence; height from 5 to 6 ft. Large pods of fine flavor, and exhibition variety. Pt. 75c., qt. \$1.25.

Onward. Decidedly the best Pea of recent introduction; pods are 4 in. long with 6 to 8 deep green peas of the finest flavor. Pt. 50c., qt. 90c.

The Britisher. A prolific, strong growing variety with medium green foliage. Pods are perfectly straight; pointed at the ends, and of a medium green color, containing nice, large, nicely flavored peas. 4 ft. Main crop; wrinkled. Pt. \$1.00, qt. \$1.75.

Quite Content, Carter. The largest and finest podded Pea in cultivation. Received First Class Certificate from the Royal Horticultural Society of London. A main crop variety; grows 5 feet high; foliage and pod deep green; pods 6 to 7 in. long, hanging mostly in pairs; ten to twelve peas in a pod. Flavor superb. Pt. 50c., qt. 90c.

Stratagem. A dwarf, wrinkled, blue marrow; a heavy cropper, and produces large, remarkably well filled pods of excellent flavor. One of the best. 2 ft. Pt. 30c., qt. 55c., 4 qts. \$1.75.

Telephone. Immensely productive, of the finest quality and excellent sugary flavor, the pods are of large size and closely packed with large, delicious peas. 4 ft. Pt. 40c., qt. 75c., 4 qts. \$2.25.

The Gladstone. One of the best late Peas; immense cropper, long, curved, deep green, well filled pods. 3½ ft. Pt. 50c., qt. 90c., 4 qts. \$3.25.

Yorkshire Hero. A large dwarf, wrinkled variety of delicious flavor and great productiveness. 2½ ft. Pt. 30c., qt. 55c., 4 qts. \$1.75.

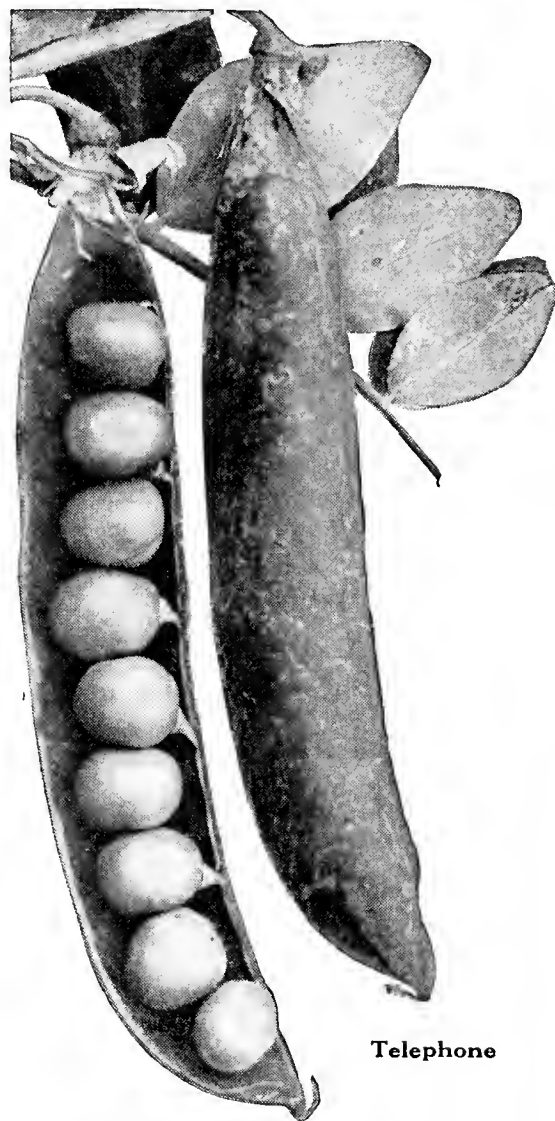

Telephone

PEPPER *One ounce will produce about 1,500 plants*

Sow in March or April in a hotbed and transplant into open ground late in May or early in June when the weather has become well settled, as the plants are quite tender. Set in rows about 2 feet apart, and 15 inches apart in the row. A warm, sandy loam is best suited to their growth.

California Wonder. A sweet variety of great merit. Heavily productive over a long season. Fruits very large, smooth and regular. Pkt. 15c., oz. 75c., ¼ lb. \$2.50.

Chinese Giant. Very large, flesh mild and thick. Pkt. 10c., oz. 50c., ¼ lb. \$1.50.

Golden Dawn. A large yellow variety, resembling the bell in shape. Mild and sweet. Pkt. 10c., oz. 50c., ¼ lb. \$1.50.

Harris Early Giant. The largest Pepper grown; early and prolific. The plants produce enormous yield. The Peppers are 5 in. high and 3½ in. through; deep green turning to brilliant red. Flesh thick and of a very sweet flavor. Pkt. 15c., oz. 75c.

Large Bell, or Bull Nose. Good for Mangoes; early, sweet and less pungent than many; one of the best. Pkt. 10c., oz. 50c., ¼ lb. \$1.50.

Long Red Cayenne. A long, slim pod, rather pointed, and when ripe, of a bright red color, extremely strong and pungent. Pkt. 10c., oz. 50c.

Neapolitan Large Early. The earliest of the large, sweet Peppers. Pkt. 10c., oz. 50c., ¼ lb. \$1.50.

Ruby King. Long, about 5 in.; very thick, fine, mild flavor. Pkt. 10c., oz. 50c., ¼ lb. \$1.50.

Squash. Flesh thick, mild and pleasant to the taste, though more piquant than some. Pkt. 10c., oz. 50c., ¼ lb. \$1.50.

Sunnybrook. The fruit measures 2½ to 3 in. thick and 2 to 2½ deep. The skin is smooth and of a deep scarlet color. The flesh is unusually thick and very sweet. Pkt. 10c., oz. 50c., ¼ lb. \$1.50.

Sweet Mountain. Grows to large size; shape somewhat like the Bell, but much larger. Pkt. 10c., oz. 50c., ¼ lb. \$1.50.

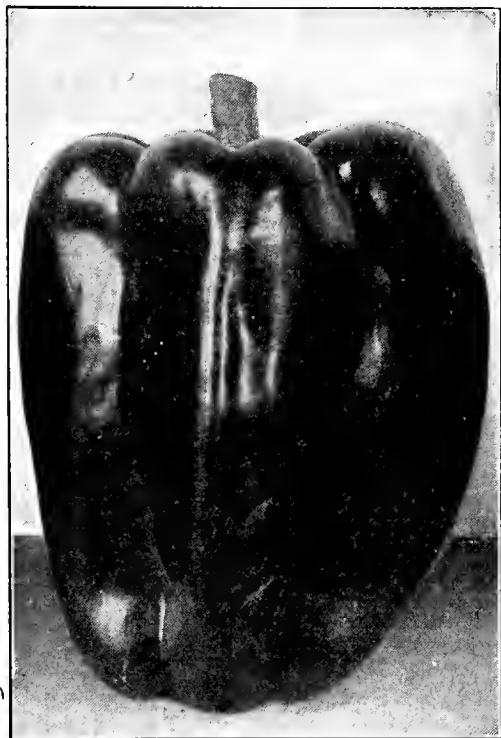

Chinese Giant Pepper

POTATOES

Eight to ten bushels will plant one acre.

Owing to unsettled Market Conditions prices will be given on application.

A good, sandy loam produces the best Potatoes, but they can be grown on all kinds of soil. New or pasture land, with the turf freshly turned, produces the finest crop. Make furrows of good depth, 3 feet apart. Scatter a liberal dressing of phosphate or decayed stable manure along the drill, and set the seed about 10 inches apart in the rows. Cover with about 2 inches of soil, and begin to cultivate when the plants are well up. At each successive hoeing, bring additional soil about the plants. A change of seed is advisable.

Delaware. Tubers large, smooth and of best quality; white and yields well.

Early Ohio. One of the best for early market. A week earlier than Early Rose. Of fine quality.

Early Rose. The well known variety; early and prolific.

Green Mountain. We can recommend this variety as one of the best for all purposes.

Irish Cobbler. Cream white color and of excellent quality. A vigorous grower, early, ripens uniformly, and keeps well.

New Queen. Flesh white and quality good; early and productive. In shape and color it resembles the Beauty of Hebron.

Norcross. A splendid sort, uniform size and fine quality.

Rural Russet. A reliable late variety, practically blight-resistant. Quality excellent. A good keeper.

Spaulding Rose. A valuable early Potato of exceptional quality. Cooks white and mealy; does well in light soils.

SWEET POTATO PLANTS

Culture—The young plants should be set in hills about 4 feet apart and 5 inches above the ground level. A light soil and sunny location are preferable. Rooted slips ready in May.

Nansemond. Best sort for New England. Plants, \$1.25 per 100, \$10.00 per 1000; add 15c. per 100 if wanted by parcel post.

PUMPKIN

One ounce will plant 20 hills. One pound 250 hills.

Sow in good soil in May, when the ground has become warm, in hills 8 or 10 feet apart each way; or in fields of Corn, about every fourth hill. The Pumpkin is not so particular in regard to soil as the Melon or Cucumber, but in other respects is cultivated in a similar manner. If planted in hills by themselves, thin out the plants when beginning to run, to three in each hill.

Connecticut Field. A large yellow variety, productive, and grown for feeding stock. Pkt. 10c., oz. 15c., $\frac{1}{4}$ lb. 50c., lb. \$1.50.

Mammoth. A productive variety, which grows to an immense size, often weighing more than a hundred pounds. Pkt. 10c., oz. 25c., $\frac{1}{4}$ lb. 75c., lb. \$2.50.

Sugar. A small, fine-grained, sweet Pumpkin; very prolific and a fine table variety. Pkt. 10c., oz. 15c., $\frac{1}{4}$ lb. 50c., lb. \$1.50.

Winter Luxury. Flesh thick, sweet and excellent for pies. Pkt. 10c., oz. 25c., $\frac{1}{4}$ lb. 75c.

RADISH

One ounce will sow 100 feet of drill.

For very early use seeds can be sown in frames in February, making successive sowings every two or three weeks. Sow also in the open ground the last of April in light, rich, sandy soil, selecting a warm or sheltered location. Later sowings can be made at intervals during the Summer in a moist location where they can grow quickly. Sow broadcast or in drills. Seeds of Winter Radishes should be sown during Midsummer, and the Radishes can be kept during Winter if covered with sand and placed in a cool cellar.

Celestial. A quick growing radish either in the fall or spring. The flesh and skin white. Pkt. 10c., oz. 25c., $\frac{1}{4}$ lb. 75c.

Cincinnati Market. Long, smooth, slender, about 6 to 7 in. long, and $\frac{5}{8}$ in. in diameter at the shoulder. It is of a fine, deep red color and one of the best of the early long varieties. Pkt. 10c., oz. 25c., $\frac{1}{4}$ lb. 75c.

Early Crimson Giant. Grows to a large size without becoming pithy. Excellent for forcing. Pkt. 10c., oz. 25c., $\frac{1}{4}$ lb. 75c.

Earliest Forcing Deep Scarlet Turnip. Short leaved; very early; brilliant red; particularly fine for use in frames. Pkt. 10c., oz. 25c., $\frac{1}{4}$ lb. 75c.

Early Scarlet Globe. Of distinct shape, brilliant color, crisp and white; excellent for forcing. Pkt. 10c., oz. 25c., $\frac{1}{4}$ lb. 75c., lb. \$2.25.

Early Scarlet Turnip. Small, round Radish; very tender, mild and of quick growth. Pkt. 10c., oz. 25c., $\frac{1}{4}$ lb. 75c.

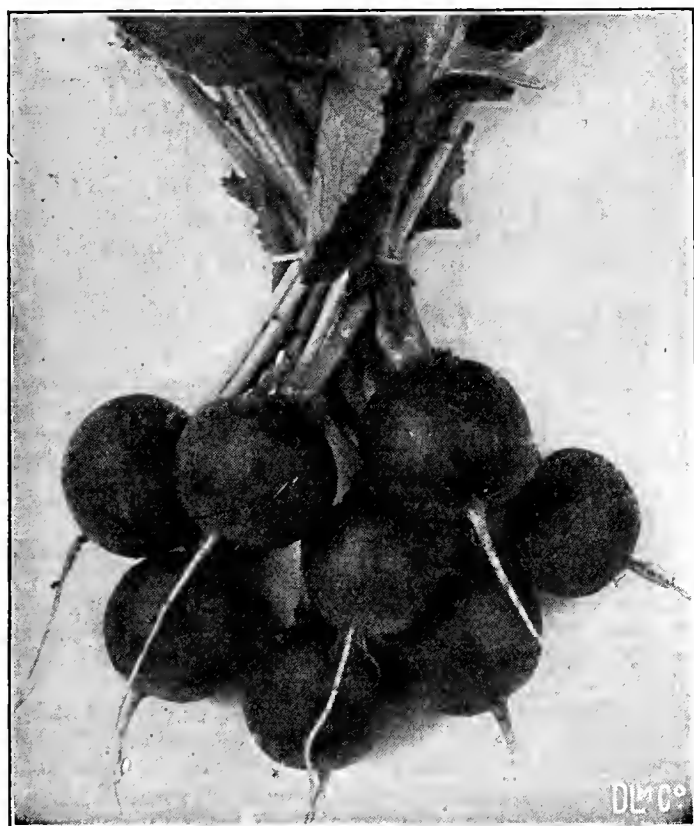

Early Scarlet Globe

RADISH—Continued

- Early, Scarlet Turnip, White Tipped.** A very early variety; color deep scarlet with white tip. Good forcer. Pkt. 10c., oz. 25c., $\frac{1}{4}$ lb. 75c.
- French Breakfast.** Scarlet, with white tip; shape nearly oval; good for forcing or Summer sowing. Pkt. 10c., oz. 25c., $\frac{1}{4}$ lb. 75c.
- Iceberg.** Quick growing; clear white. Fine for forcing. Pkt. 10c., oz. 25c., $\frac{1}{4}$ lb. 75c.
- Long Black Spanish.** One of the hardiest and best for Winter use. Pkt. 10c., oz. 25c., $\frac{1}{4}$ lb. 75c.
- Olive-Shaped Scarlet.** A very handsome, quick growing variety; excellent quality. Pkt. 10c., oz. 25c., $\frac{1}{4}$ lb. 75c.
- Round Black Spanish.** Skin black; roots globe-shaped; white fleshed and piquant flavor. Pkt. 10c., oz. 25c., $\frac{1}{4}$ lb. 75c.
- Rose China Winter.** Bright rose color, flesh firm and fine for Winter use. Pkt. 10c., oz. 25c., $\frac{1}{4}$ lb. 75c.
- Sakurajima.** Largest sort in cultivation. Sow early in rich soil. Pkt. 10c., oz. 25c., $\frac{1}{4}$ lb. 75c.
- White Turnip.** Very early, flesh and skin white, of mild flavor; excellent for Summer use. Pkt. 10c., oz. 25c., $\frac{1}{4}$ lb. 75c.
- White Strasburg.** Roots oblong, of a pure white color and mild flavor. Pkt. 10c., oz. 25c., $\frac{1}{4}$ lb. 75c.
- White Stuttgart.** A quick growing variety of large size and of good quality. Pkt. 10c., oz. 25c.



Spinach

RHUBARB

One ounce will produce about 750 plants

Rhubarb succeeds best in deep, rich loam; the richer its condition, and the deeper it is stirred, the better, as it is scarcely possible to cultivate too deeply or to manure too highly. It is propagated by seeds, or by division of the roots—the latter being the usual method. Sow the seeds in drills 18 inches apart, and thin out the plants to 9 inches apart in the drills. When the plants are one year old transplant into beds, setting the plants 5 feet apart each way. Do not cut until the second year and give a liberal dressing of manure every Fall.

Linnaeus. The earliest and best for garden use; not as coarse and fibrous as the larger sorts. Pkt. 10c., oz. 50c., $\frac{1}{4}$ lb. \$1.50.

Victoria. The variety in general use for the market; yields immense crops. Pkt. 10c., oz. 50c., $\frac{1}{4}$ lb. \$1.50.
Roots. Either variety. Each 25c., doz. \$2.75.

SALSIFY, or VEGETABLE OYSTER

One ounce will sow 50 feet of drill

A very delicate and nutritious vegetable, especially esteemed for its peculiar oyster flavor. Sow the seed early in Spring, in drills 12 inches apart and 1 inch deep, thinning out the young plants to 6 inches. The roots will be ready for use in October, when a supply should be taken up and scored like Carrots. Those remaining will suffer no injury by being left in the ground till Spring.

Long White French. Pkt. 10c., oz. 35c., $\frac{1}{4}$ lb. \$1.25.

Mammoth Sandwich Island. Tender and delicious; very superior. Pkt. 10c., oz. 30c., $\frac{1}{4}$ lb. \$1.00.

Scorzonera (Black Salsify). Cultivate the same as Salsify. The roots should not be scraped, but simply washed, boiled tender, then peeled and served like Asparagus. Pkt. 10c., oz. 50c., $\frac{1}{4}$ lb. \$1.50.

SPINACH

*One ounce will sow 50 feet of drill.
Twenty pounds will sow an acre.*

Spinach may be grown on any ordinary soil. It is grown both as a Spring and Summer crop. For early use sow in August or September, in drills 12 to 14 inches apart. At the approach of cold weather cover lightly with straw, or any handy litter. Uneover when the plants begin to make a new growth in Spring. For Summer use sow early in Spring, in same way as above, using rather less seed. If the plants stand too thick, thin to 3 or 4 inches apart. A liberal dressing of good manure should be used. The land can hardly be made too rich.

Packets 10c. except where noted.

Bloomsdale or Savoy-leaved. A valuable variety with wrinkled leaves, resembling the Savoy Cabbage; it is very hardy and prolific. Oz. 15c., $\frac{1}{4}$ lb. 35c., lb. \$1.25.

King of Denmark. Especially desirable for sowing during April and May. Oz. 15c., $\frac{1}{4}$ lb. 35c., lb. \$1.25.

New Zealand (Tetragonia expansa). A plant of a different genus, but of similar character and use as Spinach. May be started in a hotbed and transplanted or sown out of doors when the ground is warm, allowing two feet between the plants. Pkt. 10c., oz. 25c., $\frac{1}{4}$ lb. 75c., lb. \$2.25.

Nobel, Giant-leaved. By far the best of the so-called smoothleaved varieties. It grows rapidly and remains a long time in marketable condition. Oz. 15c., $\frac{1}{4}$ lb. 35c., lb. \$1.25.

Perpetual or Spinach Beet. Producing green leaves in abundance close to the ground. This variety will give

a constant supply of Spinach throughout the season. Pkt. 10c., oz. 25c., $\frac{1}{4}$ lb. 75c.

Princess Juliana. The leaves are large; very dark green in color; thick in texture and very much blistered; does not quickly run to seed. A fine variety for the market. Oz. 15c., $\frac{1}{4}$ lb. 35c., lb. \$1.25.

Round Thick-Leaved. Leaves large, thick and fleshy; the variety generally grown for market and equally good for Spring or Fall sowing. Oz. 15c., $\frac{1}{4}$ lb. 35c., lb. \$1.25.

Savoy Blight-resisting. On account of its resistance to blight, the yield is often very large. A valuable variety to use for Fall sowing. Oz. 15c., $\frac{1}{4}$ lb. 35c.

Savoy-leaved, long-standing. Darker green and more heavily crumpled than Bloomsdale, will stand ten days longer before bolting to seed. Oz. 15c., $\frac{1}{4}$ lb. 35c.



Hubbard

Bay State

Delicious

SQUASH

One ounce of the small-seeded variety will plant 40 hills; of large-seeded, 15 hills.

Squashes, being very tender and sensitive to cold, should not be planted until the weather becomes warm and settled. Plant in well-manured hills, in the same manner as Cucumbers and Melons, the bush varieties 3 or 4 ft. apart each way, and the running kinds from 6 to 8 ft. apart. Sow 8 to 10 seeds to a hill, thinning out after they have attained their rough leaves, and danger from bugs is past, leaving two or three of the strongest plants in each hill.

Bay State. Blue, shell hard; flesh fine and dry, of sweet flavor; bright golden yellow color. Pkt. 10c., oz. 25c., $\frac{1}{4}$ lb. 75c.

Boston Marrow. A Fall and Winter variety of oval form, skin thin; when ripe, bright orange; an excellent keeper and of superior quality. Pkt. 10c., oz. 25c., $\frac{1}{4}$ lb. 75c.

Delicious. One of the best varieties for table use. It is a Fall and Winter Squash, excellent at all seasons. Pkt. 10c., oz. 25c., $\frac{1}{4}$ lb. 75c.

Des Moines. It is a small, dark green, acorn-shaped Squash, almost black in color, with deep ridges, hard shell, dry meat, small seed cavity, usually about 6 in. long and 4 in. in diameter. When fully matured it is an excellent keeper, therefore one of the best for home garden. Pkt. 10c., oz. 25c., $\frac{1}{4}$ lb. 75c.

Early Mammoth, White Scalloped. One of the earliest Summer Squashes; flat, scallop-shaped; light cream color. Pkt. 10c., oz. 25c., $\frac{1}{4}$ lb. 75c.

Early Prolific, or Orange Marrow. The earliest and most productive Fall and Winter Squash; color bright orange, flesh dry and sweet. Pkt. 10c., oz. 25c., $\frac{1}{4}$ lb. 75c.

Early Giant Summer Crookneck. Very early variety; long shape and of a bright yellow color. Pkt. 10c., oz. 25c., $\frac{1}{4}$ lb. 75c., lb. \$2.50.

Essex Hybrid Turban. Productive, with very hard shell; a solid, heavy, thick-fleshed sort of excellent flavor and keeps admirably. Pkt. 10c., oz. 25c., $\frac{1}{4}$ lb. 75c.

Giant Straightneck Summer. This is a new type, produced by one of New England's leading market gardeners. By careful selection he has produced a type nearly double the size of any other Summer Squash. Despite its large size the flesh is rich and fine flavored. Its attractive appearance has made it popular with the

market gardeners. We believe this new variety will eventually replace all other Summer varieties. Pkt. 15c., oz. 50c., $\frac{1}{4}$ lb. \$1.50, lb. \$5.00.

Hubbard. Standard Winter Squash; grown more extensively than any other late variety; color, dark green, shell extremely hard; flesh dry, fine grained and sweet; excellent keeper. Pkt. 10c., oz. 25c., $\frac{1}{4}$ lb. 75c., lb. \$2.50.

Hubbard, Mammoth Warted. A superior strain of mammoth size and entirely covered with warty excrescences. Rich, dark green color and of very best quality. Pkt. 10c., oz. 25c., $\frac{1}{4}$ lb. 75c., lb. \$2.50.

Hubbard, Golden. Earlier than Hubbard; color a rich orange red; shell hard and warty. Pkt. 10c., oz. 25c., $\frac{1}{4}$ lb. 75c., lb. \$2.50.

Hubbard, Symmes Blue. A superior strain, thick meated, fine grained, dry and very sweet. A heavy cropper and good keeper. Pkt. 10c., oz. 35c., $\frac{1}{4}$ lb. \$1.25.

Marblehead. Resembles Hubbard, but is earlier; has a gray, hard shell; good Winter sort. Pkt. 10c., oz. 25c., $\frac{1}{4}$ lb. 75c., lb. \$2.50.

The Warren. Resembles the Essex Hybrid but has a shell generally harder and thicker. The color is of a richer and deeper orange. The flesh is of excellent quality. Pkt. 10c., oz. 50c., $\frac{1}{4}$ lb. \$1.50.

Vegetable Marrow, English. Grows about 9 inches long. Pale straw colored, changing to a deeper shade. Flesh white. Pkt. 10c., oz. 25c., $\frac{1}{4}$ lb. 75c.

Vegetable Marrow, Italian (Cocozelle di Napoli). Skin smooth, mottled, dark and light green. Grows from 12 to 20 inches long. Flesh delicate green; quality fine. Pkt. 10c., oz. 25c., $\frac{1}{4}$ lb. 75c.



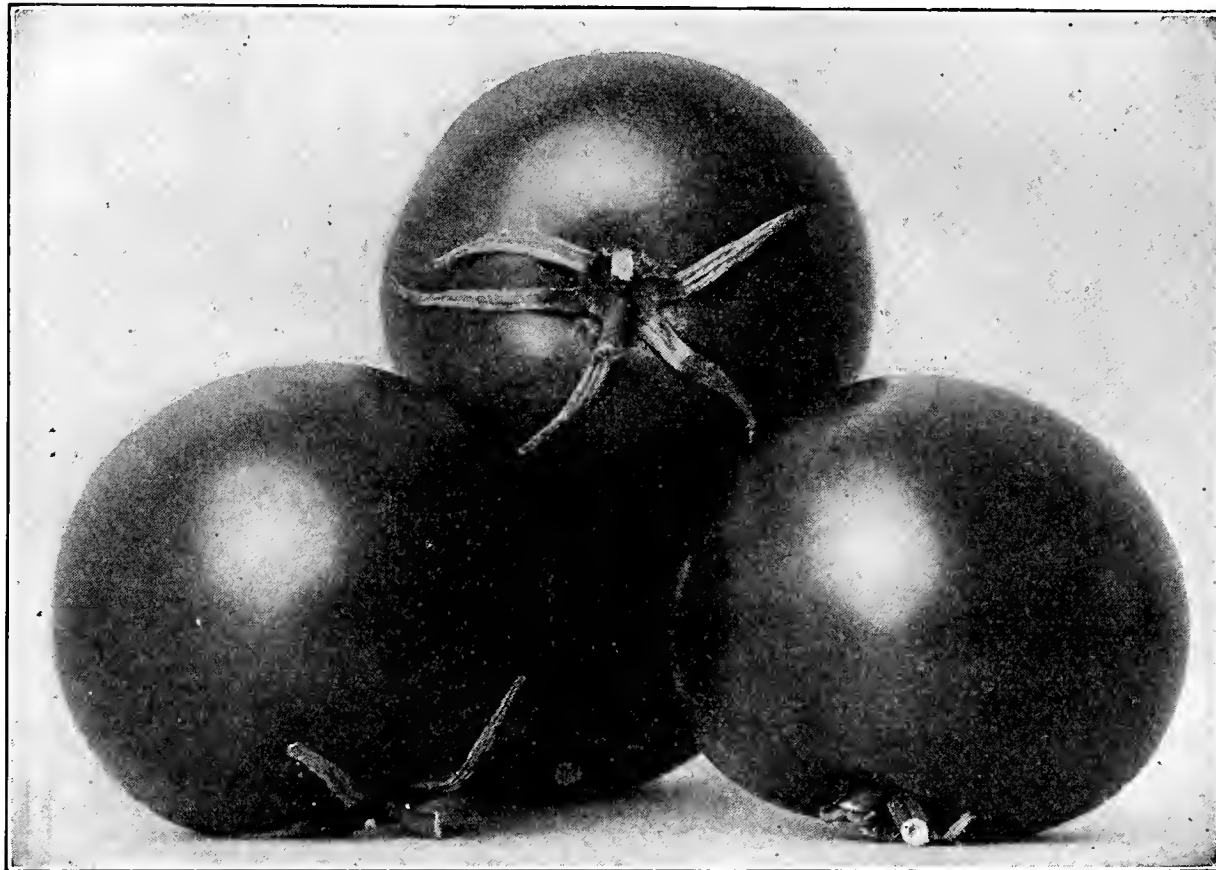

Tomato, Lister's Prolific—See page 23

TOMATO

One ounce will produce 1500 plants

Seed should be sown in a hotbed about the first week in March, in drills 5 inches apart. When the plants are about 2 inches high they should be set out 4 or 5 inches apart in another hotbed, or removed into small pots, allowing a single plant to a pot. About the middle of May the plants may be set out in the open ground; they are planted for early crops on light, sandy soil, at a distance of 3 feet apart, in hills in which a good shovelful of rotted manure should be mixed. On heavy soil, which is not suited for an early crop, they should be planted 4 feet apart. Water freely at the time of transplanting, and shelter from the sun for a few days until the plants are established.

Ailsa Craig. One of the best forcing varieties, also does well outdoors; a heavy cropper. Fruit medium size, smooth and of a rich scarlet color. Pkt. 25c.

Beauty, Livingston's. Rich, glossy crimson; large size, very smooth and solid. Pkt. 10c., oz. 50c., $\frac{1}{4}$ lb. \$1.50.

Belmont, Improved. An excellent scarlet variety. Early, medium size; solid and smooth. Pkt. 10c., oz. 50c., $\frac{1}{4}$ lb. \$1.50.

Best of All, Sutton's. A good forcing or outdoor variety; deep scarlet; solid. Pkt. 25c., oz. \$2.00.

Bonny Best. Early, productive. Smooth, solid and uniform in size; scarlet. Pkt. 10c., oz., 50c., $\frac{1}{4}$ lb. \$1.50

Break O'Day. An early Tomato of the Marglobe type, fruit of good size, color scarlet; smooth and of good quality. Pkt. 15c., oz. \$1.00, $\frac{1}{4}$ lb. \$3.00.

Carter's Sunrise (True Stock). One of the best Tomato for indoor or outdoor cultivation. Perfect in shape, of good size and free cropper; the fruit is bright red. Pkt. 25c., oz. \$1.75.

Chalk's Early Jewel. Large, solid, smooth, bright red variety. Pkt. 10c., oz. 50c., $\frac{1}{4}$ lb. \$1.50.

Cherry Red. Small, round fruit, resembling Cherries; for preserving. Pkt. 10c., oz. 50c.

Comet. One of the best for forcing; brilliant scarlet color; medium size, smooth and solid. Pkt. 10c., oz. 75c.

Crockford's Alaska, or "New Trellis." Without doubt the finest forcing Tomato on the market, also the best for outdoor if grown on trellises. Rich, deep color, solid flesh. Pkt. 50c.

Currant, or Grape. Fruit very small, bright red, in clusters. Pkt. 10c., oz. 50c.

Dwarf Champion. Of compact, upright growth. Fruit solid, smooth, purplish-red. Pkt. 10c., oz. 40c., $\frac{1}{4}$ lb. \$1.25.

Dwarf Stone. Resembles Dwarf Champion; fruit larger and more prolific; fine color. Pkt. 10c., oz. 40c., $\frac{1}{4}$ lb. \$1.25.

Earliana. The earliest red Tomato. Very smooth; fine for market. Pkt. 10c., oz. 40c., $\frac{1}{4}$ lb. \$1.25.

Favorite, Livingston's. A superior Tomato. Bright red, smooth, solid and of good size. Pkt. 10c., oz. 50c., $\frac{1}{4}$ lb. \$1.50.

Golden Ponderosa. A large golden yellow variety of excellent quality. Pkt. 10c., oz. 50c., $\frac{1}{4}$ lb. \$1.50.

Golden Queen. The best yellow variety, medium size smooth and solid. Pkt. 10c., oz. 40c., $\frac{1}{4}$ lb. \$1.25.

Globe Livingston's. Very early; large, smooth variety. Pkt. 10c., oz. 40c., $\frac{1}{4}$ lb. \$1.25.

TOMATO—Continued

- John Baer.** An early bright scarlet new Tomato. Large and fleshy. Pkt. 10c., oz. 50c., $\frac{1}{4}$ lb. \$1.50.
- Lister's Excelsior.** This variety is the result of a cross between Ailsa Craig and Lister's Prolific; one of the best for forcing or outdoor culture; a heavy cropper of good flavor and color. Original pkts. 35c.
- Lister's Prolific.** This variety combines all the essential qualities of productiveness, size, flavor and color; whether planted out or grown in a greenhouse it has proved a remarkably valuable variety. Pkt. 35c.
- Lister's Protection.** A new variety—the best of Lister's productions. Color dark crimson, a heavy cropper, perfect in shape and size. Pkt. 75c.
- Marglobe.** Of recent introduction. A midseason variety entirely immune from rust, pure scarlet, globe-shaped. Good size, heavy cropper and fine quality. Pkt. 10c., oz. 50c.

- Peach.** For preserves, pickles, etc. Resembles a Peach in color. Pkt. 10c., oz. 40c.
- Perfection, Livingston's.** An early variety, of blood-red color; perfectly smooth; ripens uniformly, and bears abundantly until frost; excellent for canning. Pkt. 10c., oz. 40c., $\frac{1}{4}$ lb. \$1.25.
- Ponderosa.** Very large, solid and of excellent flavor. Pkt. 10c., oz. 50c., $\frac{1}{4}$ lb. \$1.50.
- Scott's Ellenbank.** A new variety, very large cropper, carrying trusses from 3 to 4 lbs. One of the best Tomatoes for indoor or outdoor cultivation. Pkt. 75c.
- Stirling Castle.** This is one of the best for indoor culture. Round, smooth, delicious flavor. Pkt. 25c. $\frac{1}{4}$ oz. \$1.00, oz. \$3.00.
- Stone Livingston's.** Large, bright scarlet, solid, smooth, later than many, very productive. Pkt. 10c., oz. 50c., $\frac{1}{4}$ lb. \$1.50.
- Yellow Plum.** Bright lemon-colored, oval, small; useful for preserves. Pkt. 10c., oz. 40c., $\frac{1}{4}$ lb. \$1.25.

TOBACCO

- Connecticut Seed-leaf.** Suited to the climate of the Northern and Middle States. Pkt. 10c., oz. 75c.
- Havana.** Imported seed. Pkt. 10c., oz. 75c.

TURNIP

One ounce will sow 150 feet of drill; $1\frac{1}{2}$ lbs. per acre.

Turnips do best in highly enriched, light, sandy or gravelly soil; sow the earliest varieties as soon as the ground can be worked in the Spring, in drills 12 to 18 inches apart. Seed can also be sown broadcast, using 3 pounds to the acre. For a continuous supply through the season, sowings should be made every two weeks until the last of July, from which time until the middle of August the principal sowings are made for Fall and Winter use. Swedish or Rutabaga Turnips are largely grown for a farm crop, as well as for the table; make sowings from the 10th of June until the last of July, in drills 2 to 3 feet apart, and the plants when well up should be thinned to from 8 to 10 inches apart. They are best preserved in a pit or cellar during the Winter, and are excellent for the table early in Spring.

- Extra Early Milan, White.** A beautiful early variety with small tops, tender and sweet. Pkt. 10c., oz. 25c., $\frac{1}{4}$ lb. 75c.
- Golden Ball.** Bulb of fine form and bright yellow color, a fine keeper; unsurpassed for table use. Pkt. 10c.; oz. 25c., $\frac{1}{4}$ lb. 75c., lb. \$2.25.
- Milan Early, Purple Top.** The earliest of the white flesh varieties. Pkt. 10c., oz. 25c., $\frac{1}{4}$ lb. 75c.
- Nonsuch.** A purple top variety of great merit, has been carefully selected and improved. The roots grow to a large size and are of the finest quality. A very heavy cropper. Oz. 25c., $\frac{1}{4}$ lb. 75c.
- Purple Top Strap Leaf.** A well known variety, extensively grown both for table and for stock. Pkt. 10c., oz. 15c., $\frac{1}{4}$ lb. 50c., lb. \$1.50.
- Purple Top White Globe.** A handsome, globe shaped variety, valuable for market purposes. Pkt. 10c., oz. 15c., $\frac{1}{4}$ lb. 50c., lb. \$1.50.
- Seven Top.** This variety extensively grown for Winter greens. Oz. 15c., $\frac{1}{4}$ lb. 40c.
- White Egg.** Oval shaped variety for Spring or Fall sowing; flesh white, firm, fine-grained, mild and sweet. Pkt. 10c., oz. 15c., $\frac{1}{4}$ lb. 50c., lb. \$1.50.
- Yellow Aberdeen.** Hardy, productive and a good keeper; yellow, flesh firm, good for table use or feeding stock. Pkt. 10c., oz. 15c., $\frac{1}{4}$ lb. 50c., lb. \$1.50.

- Monarch.** A deep yellow fleshed, purple top variety, smooth, oval form, slightly tapering at ends; small neck and fine for table use. Pkt. 10c., oz. 15c., $\frac{1}{4}$ lb. 50c., lb. \$1.25.
- Snowball.** A very early, pure white variety of medium size. Pkt. 10c., oz. 15c., $\frac{1}{4}$ lb. 50c.
- Shamrock.** An excellent variety; grows with small top and very few leaves; a good keeper; desirable either for stock or table use. Pkt. 10c., oz. 15c., $\frac{1}{4}$ lb. 50c., lb. \$1.25.
- White Cape Cod.** A superior variety for table or stock; flesh firm, sweet and juicy. Pkt. 10c., oz. 25c., $\frac{1}{4}$ lb. 75c., lb. \$2.00.
- White French.** Oval in form, clear white flesh; one of the best Winter Turnips. Pkt. 10c., oz. 15c., $\frac{1}{4}$ lb. 50c., lb. \$1.25.

Rutabaga, or Swedish Turnip

- Budlong Swede.** A choice strain of the white Rutabaga, earlier than others, and more nearly round in form. Sweet, of excellent flavor and keeps well. Pkt. 10c., oz. 15c., $\frac{1}{4}$ lb. 40c., lb. \$1.00.
- Carter's Imperial.** An excellent sort, for either table use or feeding stock. Flesh yellow, solid, firm, sweet and rich. Pkt. 10c., oz. 15c., $\frac{1}{4}$ lb. 40c., lb. \$1.00.
- Improved American, Purple Top.** A yellow-fleshed, purple top variety grown for stock or table. Pkt. 10c., oz. 15c., $\frac{1}{4}$ lb. 50c., lb. \$1.25.

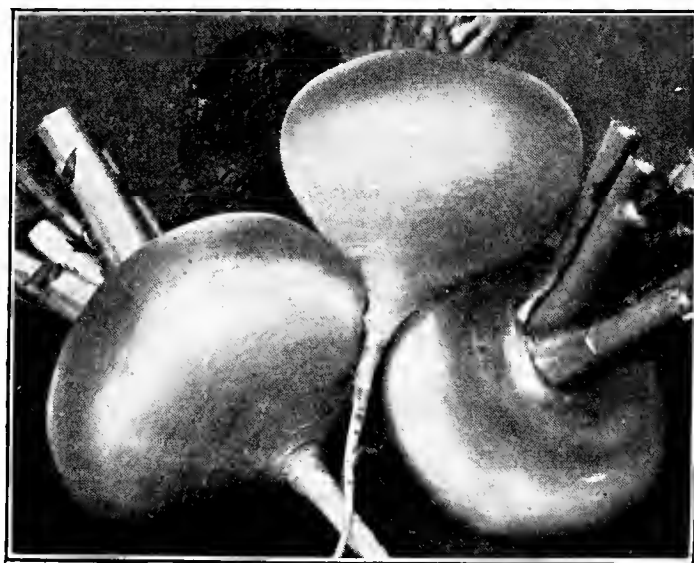

Turnip, Purple Top Strap-leaf

Pot, Sweet and Medicinal Herbs

Plant in the Spring when the ground is warm, in drills, covering lightly. When the plants are well up, thin out or transplant to about 4 inches apart. They should be harvested on a day just before the blossom develops, dried quickly and bottled, or closely packed in dry boxes with the air entirely excluded.

Anise (*Pimpinella anisum*). Annual. Used for flavoring and garnishing. Pkt. 10c., oz. 60c.

Arnica (*Arnica montana*). Perennial. Used in medicine as a narcotic and stimulant. Pkt. 10c., oz. \$2.00.

Balm (*Melissa officinalis*). Perennial. Leaves have a fragrant odor and are used medicinally. Pkt. 15c., oz. \$1.00.

Basil, Sweet (*Ocimum basilicum*). Annual. Used for flavoring soups, stews, etc. Pkt. 10c., oz. 60c.

Borage (*Borago officinalis*). Annual. Leaves are used for flavoring and bees are attracted by the flowers. Pkt. 10c., oz. 40c.

Caraway (*Carum carvi*). Perennial. Used for flavoring confectionery, bread, etc. Pkt. 10c., oz. 30c.

Catnip (*Nepeta cataria*). Perennial. Sometimes used in medicine. Pkt. 25c.

Coriander (*Coriandrum sativum*). Annual. Used in the manufacture of confectionery and liquors. Pkt. 10c., oz. 40c.

Dill (*Anethum graveolens*). Biennial. The seeds are aromatic and pungent. Used in pickling Cucumbers. Pkt. 10c., oz. 50c.

Fennel, Sweet (*Anethum foeniculum*). Perennial. Leaves when boiled are used in sauces. Pkt. 10c., oz. 50c.

Fennel, Florence (*Anethum foeniculum*). The roots are boiled, also used as salad. Pkt. 10c., oz. 50c.

Hoarhound (*Marrubium vulgare*). Perennial. Used medicinally, also for seasoning. Pkt. 10c., oz. 50c.

Hyssop (*Hyssopus officinalis*). Perennial. Used medicinally. The leaves have a pungent taste. Pkt. 10c., oz. 60c.

Lavender (*Lavendula vera*). Perennial. Yields an oil used in medicine and perfumery. Pkt. 25c., oz. \$1.00.

Lovage (*Levisticum officinale*). Perennial. An aromatic stimulant used in medicine. Pkt. 25c., oz. \$1.00.

Marjoram, Sweet (*Origanum majorana*). Annual. Aromatic and fragrant. Much used in flavoring. Pkt. 10c., oz. 80c.

Pennyroyal (*Hedeoma pulegioides*). Annual. An aromatic medicinal herb. Pkt. 15c., oz. \$1.00.

Rosemary (*Rosmarinus officinalis*). Perennial. Leaves fragrant, with warm, pungent, bitterish taste. Pkt. 25c.

Rue (*Ruta graveolens*). Perennial. Has a strong, heavy odor and bitter taste. Used medicinally. Pkt. 15c., oz. \$1.00.

Saffron (*Carthamus tinctorius*). Annual. Flowers are used as a dyestuff and in making rouge. Pkt. 10c.

Sage (*Salvia officinalis*). Perennial. More used than any other herb for dressings and seasoning. Pkt. 10c., oz. 50c.

Sorrel (*Rumex crispus*). Perennial. Used for salads or cooked and served as Spinach. Pkt. 10c., oz. 80c.

Summer Savory (*Satureia hortensis*). Annual. Used for flavoring soups and dressings. Pkt. 10c., oz. 30c.

Thyme (*Thymus vulgaris*). Perennial. Used for seasoning. Also used medicinally. Pkt. 25c., oz. \$2.00.

Wormwood (*Artemisia absinthium*). Perennial. Used medicinally and is beneficial for poultry. Pkt. 25c.

PLANTS OF HERBS—To meet the increasing demand for plants of the most popular herbs, we can supply 3 plants for \$1.25, 10 for \$3.50. Not less than 3 of one variety sold.

Vegetable Roots and Plants

We do not send Vegetable Plants by mail except where noted

ASPARAGUS. 100

"Reading Giant." Strong, two-year-old roots... \$1.50

Martha Washington..... 2.00

Mary Washington..... 2.00

ARTICHOKE, Jerusalem. Qt. 40c., by mail 10c. additional; pk. \$2.50.

ARTICHOKE PLANTS, Green Globe. May delivery. Doz. \$2.50.

BRUSSELS SPROUTS PLANTS..... Doz. 100 \$0.30 \$1.50

CABBAGE PLANTS.

Early Jersey Wakefield..... .30 1.50

Globe Curled Savoy..... .30 1.50

Henderson's Summer..... .30 1.50

Stone Mason..... .30 1.50

CAULIFLOWER PLANTS

Earliest Erfurt..... .30 2.00

Early Snowball..... .30 2.00

CELERY PLANTS. By mail, add 10c. per 100.

Boston Market..... .25 1.25

Golden Self Blanching..... .25 1.25

Giant Pascal..... .25 1.25

CHIVES, Roots. 30c. per clump, 12 clumps, \$3.00. By mail, add 10c. extra for each clump.

EGG PLANTS Doz. 100

Black Pekin..... \$1.00 \$7.00

New York Improved..... 1.00 7.00

HORSERADISH. Sets or cuttings..... .35 1.75

LETTUCE PLANTS..... .25 1.25

PEPPER PLANTS..... .50 3.00

RHUBARB ROOTS. Each Doz.

Linnaeus. Large and early..... \$0.25 \$2.75

Victoria. Largest variety..... .25 2.75

Clumps. Of either variety..... .50

TARRAGON PLANTS (*Estragon*). Strong plants. Each 50c., by mail 5c. additional... 5.00

TOMATO PLANTS (Pot-grown)

Bonny Best..... 1.00 7.00

Dwarf Champion..... 1.00 7.00

Dwarf Stone..... 1.00 7.00

John Baer..... 1.00 7.00

Stone, Livingston's..... 1.00 7.00



Winter Rye

CEREALS and MISCELLANEOUS SEEDS

Great care is used in the selection of our seed corn, grain, etc. The prices are those ruling at the time of issuing this list and may change with the market. If ordered by mail add postage at parcel post rates.

FIELD CORN

- Brewer's Yellow Dent Corn.** It is claimed to be the earliest high-yielding variety of Yellow Dent Corn in existence. Grows from 9 to 10 ft. high, ears average about 10 in. long, $7\frac{1}{2}$ in. in circumference, and bear about 22 rows of kernels, with about 50 kernels in a row. Pk. \$1.00, bu. \$3.00.
- Early Sanford.** Ears white, makes a fine quality of meal; good for fodder and ensilage. Pk. \$1.00, bu. \$3.00.
- Evergreen Sweet Fodder.** For cutting green and feeding to stock this variety excels all others in tenderness, sweetness and nutriment. Pk. \$1.50, bu. \$5.00.
- Early Canada.** One of the earliest yellow varieties; ear small; in ordinary seasons the crop will be fully ripened in August. Pk. \$1.25, bu. \$4.00.
- Leaming.** Yellow Dent variety, with large, deep grain of dark orange color; excellent for ensilage. Pk. 75c., bu. \$2.50.

SEED GRAIN

Prices subject to change with the market.

- Great care is used in the selection of our seed grain. We endeavor to have each kind true to name and free from mixture and fowl seeds. Samples and special quotation for large quantities sent on request.
- BARLEY.** Sow $1\frac{1}{2}$ to 2 bus. per acre. (48 lbs. per bu.)
- Beardless.** Bu. \$2.75.
- Montana.** Choice seed. Bu. \$2.75.
- BUCKWHEAT.** Sow 1 bu. per acre. (48 lbs. per bu.)
- Japanese.** Very prolific. Bu. \$3.00.
- Silver Hull.** Makes fine white flour. Bu. \$3.00.
- OATS.** Sow 2 to 3 bus. per acre. (32 lbs. per bu.)
- Canadian Cluster.** Heavy, with stiff straw; yields well. Bu. \$1.75.
- Montana.** A choice white variety. Bu. \$3.00.
- Welcome.** A very productive white variety, with extra strong, straight straw. Bu. \$1.75.
- RYE.** Sow $1\frac{1}{2}$ bus. per acre. (56 lb. per bu.)
- Spring.** For Spring sowing. Bu. \$2.50.
- Winter.** For Fall sowing. Bu. \$2.50.
- WHEAT.** Sow $1\frac{1}{2}$ bus. per acre. (60 lbs. per bu.)
- Spring. Marquis.** Bu. \$2.50.
- Winter. Klondvke Bald.** White grain. Bu. \$3.00.

Longfellow. The standard variety in this section; long ear, small cob, bright yellow color, and medium early. Pk. \$1.25, bu. \$4.00.

Pennsylvania Sweepstake Corn. This variety of corn will mature quicker than any other variety; the foliage extends to the ground and the stalks are sturdy and tall. A heavy cropper. Pk. \$1.75, bu. \$5.00.

Pride of the North. The earliest Yellow Dent Corn in cultivation; a safe sort for high latitudes. Pk. \$1.00, bu. \$3.00.

Stickney. Similar to Longfellow in shape and color, but earlier and more prolific. Pk. \$1.25, bu. \$4.00.

Eureka. Grows from 10 to 15 ft. high and produces a rich, heavy growth. Pk. \$1.00, bu. \$3.00.

MILLETS

Prices subject to change with the market.

Valuable for green fodder or hay, maturing in 50 to 75 days from the time the seed germinates, producing an abundant yield of forage, relished by all kinds of stock; should be sown in June and July. They must be cut while in blossom to make a good hay.

German, or Golden. A valuable annual hay and fodder crop, more productive and coarser than the Hungarian. Medium early, 4 to 5 feet high. Sow 1 bu. to the acre. Bu. \$4.00.

Japanese (Panicum Crus-galli). Grows taller and stools out more freely than the common Miller; very productive. If sown early and cut, usually produces a good second crop. It has produced in Massachusetts six tons dry hay per acre; highly recommended. Sow 20 lbs. per acre. Lb. 12c., 100 lbs. \$10.00.

Hungarian Millet (Panicum germanicum). An annual forage plant, early and productive, growing 2 to 3 ft. high, with an abundance of foliage, often yielding 2 to 3 tons per acre. Sow 1 bu. to the acre. Bu. \$4.00.



Grey's Special Lawn Grass Seed Mixtures

The following simple directions may be found useful to those who are not familiar with lawn making.

The soil should be of good depth, moderately rich, the land should be carefully drained, and the soil thoroughly pulverized. Some good fertilizer—pure ground bone, wood ashes, or a specially prepared lawn fertilizer—should be used. After sowing, the ground should be lightly raked and rolled.

The selection of seed is important. Use only such mixtures as are free from weed seeds, and such as will produce a firm, strong turf and a fine growth. A liberal quantity is necessary to secure good results (not less than 64 pounds per acre). The best time to make a lawn is from the middle of August through September. If seed is sown at this season, the grass will become strong enough to withstand the Winter, and a good lawn is assured the following season.

GREY'S SPECIAL RECLEANED LAWN GRASS SEED

In recommending this grade to our customers we are sure we are recommending a mixture which cannot be excelled for general lawn purposes. Weight 32 lbs. per bu. Sow 64 lbs. per acre. Per lb. 65c., per 100 lbs. \$37.50.

GREY'S SPECIAL BENT GRASS MIXTURE. A combination of Bent grasses and red top which will produce a turf much finer in texture than a lawn of the ordinary type. Per lb. \$1.25, per 100 lbs. \$100.00.

GREY'S GRASS MIXTURE FOR SHADED LAWNS. Fine grasses selected especially for locations partially shaded by buildings or trees. Weight 24 lbs. per bu. Per lb. 65c., per 100 lbs. \$40.00.

GREY'S BANK AND TERRACE GRASS MIXTURE. This mixture is composed of deep rooting varieties which will give satisfactory results on steep inclines or terraces. Per lb. 65c., per 100 lbs. \$40.00.

GREY'S BOSTON LAWN GRASS SEED. This mixture is composed of such varieties as long experience has shown to be adapted to produce a permanent heavy turf. Weight 16 lbs. per bu. Per lb. 35c., per 100 lbs. \$25.00.

[[**Our aim is purity, quality and service.** We are headquarters for the finest lawn grasses, agricultural grasses, fertilizers, spraying material, International Harvester Company's line of implements, plows, etc.]]

SPECIAL MIXTURES FOR TENNIS COURTS, GOLF LINKS, ETC.

The following mixtures used on many prominent golf courses, etc., in this vicinity, have given entire satisfaction.

Fair Green Mixture. For general use on golf links. Per lb. 65c., 100 lbs. \$37.50.

Putting Green Mixture. A combination of grasses best suited to produce a close, firm and lasting turf which will endure frequent cutting. Per lb. 65c., 100 lbs. \$37.50.

Tennis Court Mixture. A mixture of fine grasses especially adapted to tennis courts, which will bear trampling without injury. Per lb. 65c., 100 lbs. \$37.50.

Ball Grounds Mixture. This mixture is used by both the Leagues in Boston with the most satisfactory results. Per lb. 65c., 100 lbs. \$37.50.

Bowling Green Mixture. Mixture of fine, hardy grasses, especially adapted for bowling greens. Lb. 65c., 100 lbs. \$37.50.

Seashore Lawn Grass Mixture. A mixture of fine grasses selected for their deep rooting qualities. Per lb. 65c., 100 lbs. \$36.50.

PRICES SUBJECT TO CHANGE WITHOUT NOTICE

CHOICE GRASS SEEDS

Many growers of grass seeds offer several grades of each variety, varying greatly in price. We do not recommend nor do we sell the inferior grades. Those which we offer are strictly **high grade**, and the prices at which we offer them should not be compared with those quoted for inferior grades.

Prices may change as the season advances. If to go by mail add Parcel Post rates to cover postage

Chewing's New Zealand Fescue. A splendid grass of creeping habit, forming a close and lasting turf. An excellent grass for golf courses. Lb. 35c., 100 lbs. \$30.00.

Creeping Bent (*Agrostis stolonifera*). One of the most valuable lawn grasses because of its short growth and deep green, fine-leaved foliage. Its stoloniferous roots form a strong, close, enduring turf, which is not injured by being frequently walked on. Per lb. \$1.50.

Crested Dogtail (*Cynosurus cristatus*). Good for permanent pasture; is productive and early. 35 lbs. to the acre. Lb. 40c., 100 lbs. \$35.00.

Hard Fescue (*Festuca duriusecula*). Admirable pasture grass of fine quality. 30 lbs. to the acre. Lb. 30c., 100 lbs. \$25.00.

Italian Rye Grass (*Lolium italicum*). Valuable for mixing with other pasture grasses; sow 50 lbs. to the acre. Lb. 15c., 100 lbs. \$12.00.

Kentucky Blue (*Poa pratensis*). For pastures and lawns it has no superior, giving that peculiar rich shade of bluish green so much admired in the best lawns; also making a very close, velvety turf. It is usually sown mixed with other fine grasses; when used alone, 30 to 40 lbs. per acre. Fancy clean seed. Lb. 25c., 100 lbs. \$20.00.

Meadow Fescue (*Festuca pratensis*). One of the best grasses for permanent pasture on a great variety of soils; sow 40 lbs. per acre. Lb. 15c., 100 lbs. \$10.00.

Meadow Foxtail (*Alopecurus pratensis*). One of the best and earliest of pasture grasses. 30 lbs. to the acre. Lb. 55c.

Orchard (*Daactylis glomerata*). One of the earliest grasses; yields immense crop and is excellent for pasture or hay. Sow 40 lbs. per acre. Lb. 25c., 100 lbs. \$20.00.

Perennial Rye Grass (*Lolium perenne*). A valuable grass for pastures or meadows; also very valuable where mixed with other grasses for lawns, golf links, etc. We offer an extra choice lot of seed. Lb. 20c., 100 lbs. \$15.00.

Prince Edward Isle Bent. Produces an ideal turf for greens, fairways, bowling greens and fine lawns. Grows anywhere. Lb. \$1.75.

Red-Top. (*Agrostis vulgaris*). A valuable native permanent grass, growing in almost any soil. Invaluable for lawn seed mixture.

Unhulled Seed. 10 lbs. per bu. Lb. 18c., 100 lbs. \$15.00.

Fancy Recleaned Seed. Absolutely clean and free from chaff. 36 lbs. per bu. Lb. 20c., 100 lbs. \$18.00.

Red, or Creeping Fescue (*Festuca rubra*). A creeping rooted grass forming a close and lasting turf. Is useful for gravelly banks and exposed hillsides. It is also valuable for shaded locations. Lb. 60c., 100 lbs. \$50.00.

Rhode Island Bent. Resembles Red Top, but is of dwarfer habit. A fine, hardy, very compact grass; excellent for lawns. Sow 4 bus. per acre if alone. 14 lbs. per bus. Lb. \$1.50.

Rough Stalked Meadow Grass (*Poa trivialis*). Especially adapted to the shaded parts of lawns. It thrives on moist rich soils and in sheltered situations. Lb. 30c.

Sheep Fescue (*Festuca ovina*). This is especially valuable as it thrives on poor, light or gravelly soils. 16 lbs. per bu. Lb. 25c., 100 lbs. \$20.00.

Slender Fescue (*Festuca tenuifolia*). A variety of Sheep Fescue, with finer leaves. Lb. 40c.



Kentucky Blue Grass (*Poa pratensis*)

Sweet Vernal, True Perennial (*Anthoxanthum odoratum*). Useful to mix with other grasses; it is invaluable on account of its early growth and the fragrant odor which it imparts when drying. Lb. 75c.

Tall Fescue (*Festuca elatior*). Succeeds best on moist, alluvial and strong, clayey soils. Lb. 30c.

Tall Meadow Oat Grass (*Avena elatior*). This grass produces an abundant supply of foliage, and is valuable for pasture. Lb. \$1.50.

Timothy, "Herd's Grass" (*Phelum pratense*). It is generally sown with Red Top and Red Clover, and makes the most valuable hay. 45 lbs. per bu. Present price, lb. 12c., 100 lbs. \$10.00.

Various-leaved Fescue (*Festuca heterophylla*). Very early, hardy perennial. It is also useful in shady locations. 15 lbs. per bu. Lb. 40c., 100 lbs. \$35.00.

Wood Meadow (*Poa nemoralis*). A variety specially suited for the shaded portions of lawns, where other grasses do not grow. The creeping roots make a strong, firm sod. Lb. 45c., 100 lbs. \$40.00.

CHOICE GRASS SEEDS—Continued

Special Mixtures for Permanent Hay

Sow 50 pounds to acre.

No. 1 for Cool, Moist Soils.....	100 lbs.	\$25.00
No. 2 for High Dry Soils.....	100 lbs.	25.00
No. 3 for Wet Soils.....	100 lbs.	25.00

Special Mixtures for Permanent Pastures

Sow 50 pounds to an acre

No. 4 for Cool, Moist Soils.....	100 lbs.	\$30.00
No. 5 for High, Dry Soils.....	100 lbs.	30.00
No. 6 for Wet Soils.....	100 lbs.	30.00

CLOVER SEEDS

Prices subject to change with the market.

- Alfalfa, Genuine Grimm.** It originated in northern Minnesota. The strong branching roots of Genuine Grimm Alfalfa prevent winterkilling. Sow 15 to 20 lbs. per acre. Lb. 60c., 100 lbs. \$50.00.
- Alsike, or Swedish** (*Trifolium hybridum*). Hardest of all the Clovers, and on rich, moist soil yields an enormous quantity of hay or pasturage. Valuable for sowing with Clovers or grasses, as it forms a thick bottom and increases yield of hay. Lb. 25c., 100 lbs. \$20.00.
- Bokhara Clover** (*Melilotus alba*). Valuable sort for soiling and for ensilage and bees. Grows from 3 to 5 feet high; sown in rich soil, may be cut three times; lasts for years if cut before flowering. 15 lbs. to the acre. Lb. 15c., 100 lbs. \$12.00.

Add parcel post rates if wanted by mail.

- Crimson Clover** (*Trifolium incarnatum*). Sow in April or May; 20 lbs. to the acre. Not always hardy in New England. Lb. 20c., 100 lbs. \$15.00.
- Red Clover, Medium** (*Trifolium pratense*). The leading variety of Clover for pastures or meadows. Requires deep, rich soil. Sow in Spring. Lb. 30c., 100 lbs. \$25.00.
- Red Northern, or Mammoth.** Grows 4 to 5 ft. high, and is used to plow under for manure. Lb. 30c., 100 lbs. \$25.00.
- White Dutch Clover** (*Trifolium repens*). The best variety for lawns, as it forms a close herbage and remains green throughout the season; valuable when mixed with grass seeds for pasture. Lb. 60c., 100 lbs. \$55.00.

MISCELLANEOUS SEEDS

Prices subject to change with the market

- Beans, Soja.** A valuable fodder crop, fed green or as ensilage. **Early Green**, bu. \$7.00. **Yellow Southern**, bu. \$5.00.
- Cow Peas.** These are grown extensively in warm countries. Sheep are very fond of them, but their chief value is as a green crop to plow under. 1½ bu. per acre.
- New Era.** One of the best varieties for northern planting, maturing early and being productive. Pk. \$1.50, bu. \$5.00.
- Clay.** Prolific in yield of peas and vine. Pk. \$1.50, bu. \$5.00.
- Black.** Very prolific. Pk. \$1.50, bu. \$5.00.
- Whippoorwill.** Early. Pk. \$1.50, bu. \$5.00.
- Kaffir Corn.** White; excellent for fodder, and the seed is valuable for pigeons. Lb. 12c., 100 lbs. \$10.00.
- Peas, Canada Field.** Valuable when sown with Oats as a green fodder. Also makes good ensilage. Sow 2 bu. Oats and 1 bu. Peas per acre. Bu. \$5.00.
- Sunflower, Mammoth Russian.** Used for feeding poultry. Lb. 18c., 100 lbs. \$15.00.

- Rape, Dwarf Essex. True English Grown.** Excellent for sheep pastures, also for soiling. If sown in May, pasturing can be had in August. Sow 10 lbs. per acre broadcast. Lb. 12c., 100 lbs. \$10.00.
- Vetches, or Tares, Spring** (*Vicia sativa*). Pea-like plant grown to some extent for feeding to stock. Frequently sown with Oats. Sow 1 to 1½ bu. per acre. Bu. \$5.00.
- Vetches, Sand, Winter, or Hairy** (*Vicia villosa*). Thrives on poor, arid, sandy soil, and can be sown either in Spring or Fall. Sow 40 to 50 lbs. per acre. Bu. of 60 lbs. \$10.00.

SUDAN GRASS

A quick growing hay and pasture crop. Prepare the soil as for Corn; do not plant the seed until the soil becomes warm. Sown broadcast; use 16 to 24 lbs. of seed per acre. If planted in drills 18 to 24 in. apart, from 4 to 6 lbs. Per lb. 15c., 100 lbs. \$13.00.

BIRD SEED

(Prices subject to market fluctuations)

	Lb.	100 lbs.		Lb.	100 lbs.
Blue Maw, or Poppy.....	\$0.35	\$30.00	Millet, White French.....	\$0.20	\$18.00
Canary Seed, Choice Recleaned.....	.15	12.00	Wild Bird Food Mixture.....	.10	8.00
Hemp Seed, Recleaned Russian.....	.12	10.00	Niger Seed.....	.40	35.00
Rape Bird.....	.12	10.00	Cuttle Fish Bone.....	.50	45.00
Rape, English.....	.12	10.00	Sunflower Seed.....	.12	10.00
Mixed Bird Seed, in bulk.....	.12	10.00	Kaffir Corn.....	.05	3.00
Lettuce for Birds.....	.30	20.00	Vetch for Pigeons.....	.08	6.00
Rice, Unhulled, or Paddy.....	.18	15.00	Peas, small white.....	.10	7.00
Millet, Golden.....	.10	8.00			



Grey's Superior Quality Flower Seeds

Very carefully revised list to which many meritorious and recently introduced sorts have been added and all inferior varieties discarded.

All flower seeds mailed free on receipt of price quoted.

☛ If the number is used when ordering, it will not be necessary to write the name.

No.		Pkt.	No.		Pkt.
10	ABUTILON, Prize Mixed (Flowering Maple). Perpetual bloomers and rapid growers; seed sown indoors in March will produce plants that will bloom outdoors during the Summer and indoors all Winter.....	\$0.25		ACONITUM (Monkshood). Hardy perennials, with long spikes of hood-shaped flowers, excellent for shrubbery borders and shady places. June to Sept.	
	ACACIA. Beautiful half-hardy shrubs, with pretty, ornamental foliage and graceful racemes of yellow flowers. Soak the seed in warm water before sowing. 6 to 10 ft.		55	napellus. Large, deep blue. 3 ft. ¼ oz. \$1.25	\$0.15
15	baileyana. Long sprays of bright yellow flowers; excellent for cutting.....	¼ oz. 50c. .25	60	napellus roseum. Pink.....	.25
20	floribunda. Deep yellow.....	¼ oz. 35c. .15	65	pyrenaicum. Large yellow. 2½ ft. ¼ oz. \$1.25	.15
25	lophantha superba. Fine yellow, delicate foliage.....	¼ oz. 35c. .15	68	wilsoni. Large trusses, light blue. 4 ft.25
30	Finest Mixed Varieties. From a large collection.....	¼ oz. 35c. .15	70	Finest Mixed.	¼ oz. 60c. .10
	ACANTHUS. Stately, ornamental, hardy perennials, remarkable for their beautiful foliage and curious flowers; in Aug. and Sept. 2 to 4 ft.			ACROCLINIUM. One of the prettiest and best annual everlastings for cutting fresh or for Winter use. For drying they should be cut before fully open and hung in an airy room to dry, heads down. 15 in.	
35	mollis. The beautiful foliage of this sort is said to have given rise to the Corinthian style of architecture; flowers white. ¼ oz. 35c.	.15	75	Double Rose.	¼ oz. 35c. .10
40	mollis latifolius. Handsome sort; more robust than the preceding.....	¼ oz. 35c. .15	80	Double White.	¼ oz. 35c. .10
45	ACHILLEA, The Pearl. One of the best hardy perennials, covered with heads of pure white, double flowers from Spring till frost; fine for cutting. 1½ ft.	1-16 oz. \$1.50 .25	82	Single Rose.	¼ oz. 35c. .10
50	ACHIMENES, Superb Mixed. Profuse blooming greenhouse plants, 1 ft. high, easily grown and flowering through the Summer. The flowers vary in size and are of the richest colors.....	.50	83	Single White.	¼ oz. 35c. .10
			84	Double Mixed.	¼ oz. 35c. .10
			90	ADLUMIA cirrhosa (Mountain Fringe, or Allegheny Vine). Beautiful climber, Maiden-hair fern-like foliage, pink flowers, a self-sowing, hardy biennial. 15 ft. 1-16 oz. 75c.	.15
				ADONIS. Free-flowering border plants, with showy flowers of easy culture in any garden soil.	
			95	aestivalis (Flos Adonis). Deep crimson, free flowering annual. 1 ft. July and Aug.	¼ oz. 25c. .10
			100	vernalis. Large, yellow flowers in May and June. Hardy perennial. 1 ft. ¼ oz. \$1.00	.10
			105	AGATHEA coelestis (Blue Marguerite). Free blooming, tender perennial with blue Daisy-like flowers. Fine for Winter flowering and a good bedder. 1½ ft.25

No.		Pkt.	No.		Pkt.
	AGERATUM. Effective plants for bedding, covered with bloom throughout the season. Valuable for cutting. Half-hardy annual.		238	ANCHUSA, Blue Bird. Annual. Indigo blue..	\$0.30
108	Blue Cap. Large, deep blue flowers, small foliage; 5 in.....	\$0.25	240	capensis. Annual. Fine azure blue Forget-me-not-like flowers. 1 ft.....	1/8 oz. 35c. .10
110	Blue Perfection. Deep blue. 1 ft. 1/4 oz. 60c.	.15	242	barrelieri. Perennial. Dwarf, blue.....	.25
115	Blue Star. Bright light blue; 5 in... 1/8 oz. 75c.	.25	245	italica, Dropmore Variety. Perennial. Gentian blue; 4 ft.....	1/4 oz. 85c. .25
120	Imperial Dwarf. Dark blue; 8 in. 1/4 oz. 75c.	.15	246	Lissadell. Perennial. Bright gentian blue; 5 ft.	.35
125	Imperial Dwarf. White; 8 in.... 1/4 oz. 85c.	.15	250	ANEMONE coronaria, St. Brigid. An improved strain of the hardy garden Anemone, with larger and more brilliant flowers; 1 ft..	.20
130	lasseauxi. Fine rose. 1 1/2 ft. 1/4 oz. 50c.	.10	251	De Caen (French Anemone). Mixed.....	.15
135	Little Dorrit. Azure blue; 8 in.... 1/8 oz. 50c.	.10	253	ANTHEMIS arabica. Annual yellow.....	.10
140	mexicanum. Large, lilac blue; 1 1/2 ft. 1/4 oz. 50c.	.15	255	kelwayi (Hardy Marguerite). A most satisfactory, hardy perennial, bearing throughout the Summer golden yellow, Daisylike flowers, excellent for cutting; 2 ft.....	1/8 oz. 50c. .10
145	mexicanum album grandiflorum. Large white; 1 1/2 ft..... 1/4 oz. 50c.	.15		ANTHERICUM. One of the finest ornamental garden plants, producing freely fine spikes of sweet scented, Lilylike flowers from May to July. Hardy perennial. 1 1/2 ft.	
150	Princess Victoria Louise. Bright blue, white center; 8 in..... 1/4 oz. 75c.	.15	255	liliastrum Giant (St. Brunolly). Large white, with green spots.....	1/8 oz. \$1.00 .25
155	AGROSTEMMA coronaria, Mixed (Mullein Pink). Free flowering, hardy perennial, with bright crimson and white flowers; fine for cutting; 2 ft.....	1/4 oz. 75c. .15		ANTIRRHINUM. One of the most beautiful and useful bedding plants, blooming profusely and continuously throughout the Summer and Autumn. <i>Our seeds of these are grown by specialists and are noted for the superior size and quality of their flowers.</i>	
160	hybrida walkeri. Bright rose; hardy.....	.15		TALL VARIETIES, 2 to 2 1/2 ft.	
165	coelirosa, Mixed (Rose of Heaven). Fine annual sort, with pink and white flowers. Fine for cutting; 1 1/2 ft.....	1/4 oz. 25c. .10	269	Copper King, Maximum Type25
170	ALONSOA, Mixed (Maskflower). Charming annual, flowering throughout the Summer and Autumn; easily grown and very desirable. 1 1/2 ft.....	1/8 oz. 30c. .15	270	Giant Mixed. Finest sorts.....	1/4 oz. 75c. .15
175	ALSTROEMERIA, Finest Mixed. Handsome, Lilylike, half-hardy perennials, varying from pale yellow to orange red; 3 ft.....	1/4 oz. 75c. .25	271	Rock's White	1/8 oz. 75c. .35
	ALYSSUM. Dwarf-growing annuals, blooming profusely throughout the season.		272	Orange Beauty	1/4 oz. \$1.00 .35
180	benthami (Sweet Alyssum). White, fragrant, free bloomer; 1 ft. 4 ozs. \$1.50, oz. 50c.	.10	273	Weld Pink. Salmon pink darker shading....	1.00
185	Carpet of Snow (White Fleece). Pure white, very dwarf and sweet; 4 in. 1/4 oz. 40c., oz. \$1.25	.15	274	Peachblow. Unique in color.....	.25
187	Lilac Queen. Dwarf annual....	1/4 oz. 50c. .10	275	Giant Rose	1/4 oz. 85c. .15
190	Little Dorrit. A perfect gem for borders or beds, compact, white and sweet.. 1/4 oz. 40c.	.15	280	Giant Deep Crimson	1/4 oz. 75c. .15
195	Little Gem. White, distinct and very sweet. 1/2 ft.....	1/4 oz. 30c., oz. \$1.00 .10	285	Giant Scarlet	1/4 oz. 75c. .15
200	saxatile compactum (Gold Dust). Bright, yellow, Spring flowering, hardy perennial; 9 in.....	1/4 oz. 85c., oz. \$3.00 .15	290	Giant Striped (Dobbies).....	1/4 oz. 60c. .15
201	saxatile, Lemon Queen. Pale yellow....	1/8 oz. 75c. .15	292	Torchlight. Orange, yellow lip....	1/4 oz. 85c. .20
	AMARANTHUS. Brilliant foliaged annuals, with showy racemes of flowers; very ornamental and excellent for borders and subtropical gardening.		300	Giant White. 2 1/2 ft.....	1/4 oz. 85c. .15
205	caudatus (Love-lies-bleeding). Long drooping, scarlet racemes; 3 ft.....	1/4 oz. 25c. .10	305	Giant Yellow. 2 1/2 ft.....	1/4 oz. 85c. .15
210	cruentus (Princesfeather). Dark red, feathery spikes of flowers; 3 ft.....	1/4 oz. 25c. .10	310	Coral Rose20
212	Molten Fire. Brilliant Poinsettia like tips... .15		315	Cottage Maid. Pink, white throat. 1/4 oz. 50c.	.10
215	salicifolius (Fountain Plant). Long foliage, beautifully variegated; 3 ft.....	1/4 oz. 35c. .10	325	Fairy Queen. Rich orange salmon. 1/4 oz. 65c.	.10
220	tricolor splendens (Josephs-coat). Foliage crimson, yellow and bronze; 2 ft. 1/4 oz. 50c.	.15			
225	AMARYLLIS, Special Hybrids (Hippeastrum). Saved from extra large flowering varieties..	.50			
230	AMBROSIA mexicana. Sweet-scented annual. Useful in bouquets; 1 to 1 1/2 ft. 1/4 oz. 40c.	.10			
235	AMPELOPSIS veitchi (Boston Ivy). Popular rapid growing, hardy vine. It adheres firmly to stone, brick or wood, foliage turning very brilliant in the Autumn....	1/4 oz. 35c. .10			



Antirrhinum

No.		Pkt.
ANTIRRHINUM—Continued.		
TALL VARIETIES—Continued		
326	Feltham Beauty. Deep rose pink with white center; immense blooms.....	1/8 oz. 75c. \$0.15
328	Pink Domino. Soft rose pink, white throat.	.35
335	Collection of Six Varieties. Our selection.	.75
SEMI-DWARF VARIETIES, 15 to 18 in.		
340	Art Shades. Ranging through pink, orange and terra cotta. 1 ft.....	1/4 oz. 75c. .15
345	Amber Queen. Canary yellow, overlaid with chamois pink, golden lip.....	1/4 oz. 75c. .15
347	Beacon. Beautiful salmon-rose with deeper gold-tipped center.....	.20
350	Carmine Queen. Rose carmine.	1/4 oz. 75c. .15
355	Cottage Maid. Pale coral pink, white throat.	1/4 oz. 60c. .10
360	Crimson King. Bright crimson.	1/4 oz. 75c. .15
365	Golden Queen. Pure yellow....	1/4 oz. \$1.00 .15
373	Matchless. Apricot-buff, yellow center....	.15
374	Pink Queen. Lovely pink.....	1/8 oz. 75c. .15
375	Purity. Pure white.....	1/4 oz. 85c. .15
377	Rose Dore. Salmon rose, shaded gold.....	1/4 oz. 85c. .15
379	Rock Hybrids. Small, compact bushes.....	1/8 oz. \$1.00 .30
380	Mixed. Finest varieties.....	1/4 oz. 50c. .10
TOM THUMB VARIETIES, 8 to 10 in. Excellent for bedding, blooming all Summer.		
390	Antique Rose.	1/8 oz. 85c. .15
395	Brilliant Crimson.	1/8 oz. 85c. .15
400	Bronze and Gold.	1/8 oz. 85c. .15
405	Canary Yellow.	1/8 oz. 85c. .15
410	Dark Scarlet.	1/8 oz. 85c. .15
415	Snowflake. Extra pure white.....	1/8 oz. 85c. .15
420	Choice Mixed.	1/8 oz. 85c. .15
425	Collection of Six Varieties. Our selection.	.75
AQUILEGIA (Columbine). Beautiful, free-flowering, hardy perennials, blooming profusely through the Spring and early Summer and of easiest cultivation. Early sown seed will bloom the same season. 1 1/2 to 3 ft.		
430	Grey's Columbia Hybrids. Special long-spurred strain. The colors include the most charming combinations from the brightest to the most delicate tints.	1/8 oz. \$1.50, 1/4 oz. \$2.50 .50
435	canadensis. Scarlet and yellow, native species.....	1/4 oz. \$1.75 .15
440	chrysantha. Showy, bright yellow.	1/4 oz. \$1.75 .15
445	chrysantha grandiflora alba. Large, pure white.....	1/4 oz. \$2.00 .25
450	coerulea (Rocky Mountain Columbine). Splendid, large, light blue....	1/4 oz. \$2.50 .25
455	coerulea alba. White, long spurs.	1/4 oz. \$2.25 .25
460	coerulea rosea. Rose, long spurs.	1/4 oz. \$4.00 .25
465	glandulosa. Deep blue, with white center...	.25
466	Long-spurred Pink Shades25
467	Mrs. Scott Elliott's Strain.	1/8 oz. \$1.50 .50
475	olympica. Large delicate mauve.	1/4 oz. \$1.00 .15
478	Orange and Scarlet Shades, Long Spurred skinneri. Scarlet and yellow....	1/4 oz. \$2.00 .25
485	Mixed Single Varieties	1/4 oz. \$1.00 .10
490	Mixed Double Varieties	1/4 oz. \$1.50 .25
500	ARABIS alpina. Hardy perennial, with pure white flowers blooming early in the Spring; valuable for edgings and rockwork; will grow well in rather shaded position.....	1/4 oz. 50c. .10
505	grandiflora superba. Improved, large flowers.	1/4 oz. \$1.25 .15
510	ARALIA sieboldi. A most desirable foliage plant, well suited for the conservatory and for plunging in flower beds during Summer. 2 to 3 ft.....	.25

No.		Pkt.
515	ARCTOTIS grandis. Handsome annual from South Africa, with large, daisy-like flowers, white, with light blue center, the underside of petals being pale blue. 2 ft.	1/4 oz. 75c. \$0.15
520	ARGEMONE grandiflora. Large, pure white poppy-like flowers; showy.	2 ft. 1/4 oz. 50c. .10
	ARMERIA (Thrift, or Sea Pink). Pretty, hardy perennial for edgings, blooming all Summer; tufted flowers.	
525	formosa. Deep Rose. 1 ft.....	1/4 oz. 60c. .10
535	ASCLEPIAS tuberosa. One of the most showy of our Summer and Autumn flowering, hardy perennials, the umbels of bright, orange-colored flowers. 1 1/2 ft.....	1/4 oz. \$2.00 .25
540	ASPARAGUS plumosus nanus. Beautiful house plants; the feathery foliage is unrivaled for cutting.....	100 seeds, \$1.25 .25
545	sprengeri. Excellent plant for table decoration or to grow in pots or baskets.	1/4 oz. 35c. .25
550	ASPERULA azurea setosa. Annual species of Woodruff, with fragrant, light blue flowers, blooming through the Summer and fine for cutting. It will grow in poor soil or in shaded places. 1 ft.....	1/4 oz. 50c. .15
555	odorata (Sweet Woodruff). Hardy perennial, conspicuous in May by its pure white, sweet-scented flowers. The foliage and flowers when dried retain their fragrance. Grows well under trees.....	1/4 oz. 85c. .15

SEE PAGE IV FOR SEEDS OF PLANTS
SUITABLE FOR ROCK GARDEN

ASPHODELUS. Showy plants with handsome flower spikes. They grow well in any soil. Hardy perennial.

570	luteus. Fine, yellow, fragrant. 3 ft.	1/4 oz. \$1.00 .15
-----	--	--------------------



D. J. C.

Grey's Columbia Hybrid Aquilegia

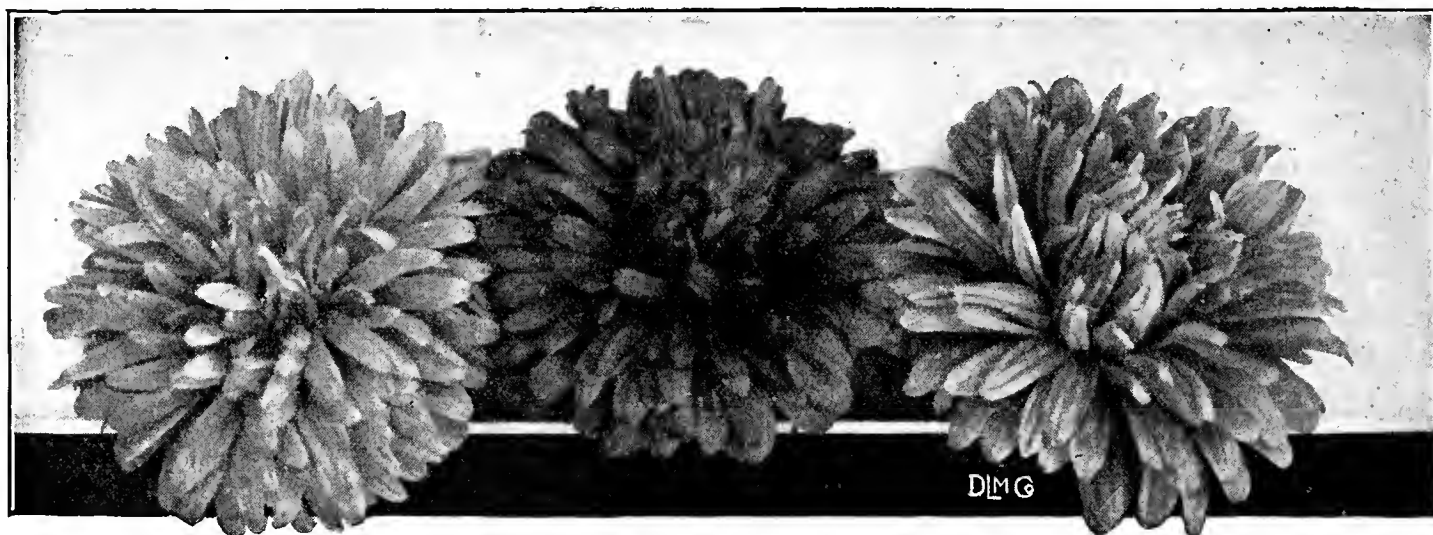

ASTERS

For best results Asters should have a good rich soil and plenty of moisture. As the roots are produced near the surface, a mulching during hot weather is very beneficial. The location of the bed should be changed every year.

- | | | | | | |
|-----|--|---------------------------|-----|--|---------------------|
| No. | | Pkt. | No. | | Pkt. |
| 575 | COLUMBIA PRIZE. Double Mixed. This mixture is especially selected from the finest large flowering, double varieties, which grow about the same height, and includes the best of recent introductions. It is without an equal..... | ¼ oz. \$1.25, oz. \$4.00. | 576 | Ball's White. Pure white, midseason branching. 2 ft..... | 1/8 oz. 85c. \$0.20 |
| | AMERICAN BRANCHING, "LATE." Superb free flowering strain, with long, strong stems and very large, graceful chrysanthemum-like flowers, double to the center. By successive sowings they may be had in bloom from Aug. to late Fall. 2 to 2½ ft. | | | DOUBLE CALIFORNIA GIANTS. A variety of Aster of the improved Comet type. Very strong stems. Petals beautifully curved and twisted. 2½ ft. | |
| 580 | Dark Violet. Velvety..... | ¼ oz. \$1.00, oz. \$3.00 | 680 | Collection of the 5 following colors, separate. | \$1.00 |
| 585 | Lavender | ¼ oz. 1.00, oz. 3.00 | 685 | Dark Purple | 1/8 oz. 85c. .25 |
| 590 | Peerless Pink. Delicate..... | ¼ oz. 1.00, oz. 3.00 | 690 | Deep Rose | 1/8 oz. 85c. .25 |
| 595 | Purple | ¼ oz. 1.00, oz. 3.00 | 695 | Light Blue | 1/8 oz. 85c. .25 |
| 600 | Rich Crimson | ¼ oz. 1.00, oz. 3.00 | 700 | Peach Blossom | 1/8 oz. 85c. .25 |
| 605 | Rose Pink | ¼ oz. 1.00, oz. 3.00 | 705 | White | 1/8 oz. 85c. .25 |
| 610 | Shell Pink | ¼ oz. 1.00, oz. 3.00 | 710 | Mixed | 1/8 oz. 85c. .25 |
| 615 | Snow White | ¼ oz. 1.00, oz. 3.00 | | CREGO'S GIANT COMET. Branching sort with large, full, fluffy flowers—through August and September. 2 ft. | |
| 620 | Mixed. All colors..... | ¼ oz. 1.00, oz. 3.00 | 712 | Crimson | ¼ oz. \$1.25 .15 |
| 625 | Collection of Six Colors. Our selection.... | .50 | 715 | Lavender | ¼ oz. 1.25 .15 |
| | AMERICAN BRANCHING "KING." Distinct from every other variety in the character of its flowers, which are of great size and substance, lasting longer when cut than any other class; the long, narrow petals are folded lengthwise, giving somewhat of a quilled appearance. The stems are exceptionally long and strong. They bloom with the late branching. 2 to 2½ ft. | | 720 | Purple. Fine color..... | ¼ oz. 1.25 .15 |
| 630 | Crimson King. Rich crimson..... | 1/8 oz. 85c. .15 | 725 | Pink. Soft shell pink..... | ¼ oz. 1.25 .15 |
| 635 | Pink King. Soft lavender pink.... | 1/8 oz. 85c. .15 | 730 | Rose. Clear, bright rose..... | ¼ oz. 1.25 .15 |
| 640 | Rose King. Bright, deep rose..... | 1/8 oz. 85c. .15 | 732 | Salmon Queen | 1/8 oz. 1.25 .15 |
| 645 | White King. Snow white..... | 1/8 oz. 85c. .15 | 735 | White. Pure snow white..... | ¼ oz. 1.25 .15 |
| 650 | Violet King. Rich violet purple.... | 1/8 oz. 85c. .15 | 736 | Mixed | ¼ oz. 1.25 .15 |
| | AMERICAN BRANCHING "ROYAL." A new class, with broad, incurved petals, possessing all the characteristics of the late branching, as to size of flower, vigor of plant, etc., but not quite so tall, they bloom earlier and are classed with the midseason varieties. 1½ to 2 ft. | | 737 | Heart of France. A pure red Aster. Very double, of strong, branching habit. It keeps its brilliant rich color when cut. 1/8 oz. | 75c. .15 |
| 655 | Enchantress Pink. Soft color.... | 1/8 oz. 75c. .15 | | OSTRICH PLUME, Improved. Superb new branching class with enormous flowers on long stems. The petals are curled and twisted, blooming in August and September; excellent for cutting or exhibition. 2½ ft. | |
| 660 | Royal Lavender. Beautiful shade.... | 1/8 oz. 75c. .15 | 740 | Collection of following 6 colors, separate... | .75 |
| 665 | Royal Purple. Rich, deep purple.... | 1/8 oz. 75c. .15 | 745 | Crimson | 1/8 oz. 75c. .15 |
| 670 | Royal Shell Pink. Delicate..... | 1/8 oz. 75c. .15 | 750 | Dark Purple | 1/8 oz. 75c. .15 |
| 675 | Royal White. Glistening white.... | 1/8 oz. 75c. .15 | 755 | Lavender | 1/8 oz. 75c. .15 |
| 678 | Royal Mixed | 1/8 oz. 75c. .15 | 760 | Rose Pink | 1/8 oz. 75c. .15 |
| | | | 765 | White | 1/8 oz. 75c. .15 |
| | | | 770 | Shell Pink | 1/8 oz. 75c. .15 |
| | | | 775 | Finest Mixed | 1/8 oz. 75c. .15 |
| | | | | PLUME, "Early Wonder." Fine strain of this beautiful Aster, blooming in July and August. 1½ to 2 ft. | |
| | | | 780 | Dark Blue | 1/8 oz. 75c. .15 |
| | | | 785 | Light Blue | 1/8 oz. 75c. .15 |
| | | | 790 | Rose | 1/8 oz. 75c. .15 |
| | | | 795 | White | 1/8 oz. 75c. .15 |

No. **ASTERS**—Continued Pkt.

IMPERIAL, "Improved American Victoria."

The best known and most extensively used of all the Summer-flowering varieties; distinguished by their delicacy of coloring, profusion of bloom and the extreme doubleness of their large flowers which are produced on long, strong stems. 2 ft.

- 805 **Dark Blue.** Very deep shade..... 1/8 oz. 85c. \$0.15
- 810 **Daybreak.** Delicate shell pink.... 1/8 oz. 85c. .15
- 815 **Lavender.** Clear, delicate shade... 1/8 oz. 85c. .15
- 820 **Rosy Morn.** Bright rose..... 1/8 oz. 85c. .15
- 825 **Purity.** Snow white..... 1/8 oz. 85c. .15
- 830 **Salmon King.** Pinkish salmon.... 1/8 oz. 85c. .15
- 835 **Yellow.** Lemon yellow, pink flush. 1/8 oz. 85c. .15
- 838 **Lady Roosevelt.** Brilliant dark rose..... 1/8 oz. \$1.00 .15

MIKADO. A superior strain of the Comet type.

The flowers are large and full, with long, graceful, reflexed petals, the center ones curling across each other in magnificent disorder. They bloom at midseason and resemble the Branching Asters in vigor and immense bloom. 2 ft.

- 845 **Pink (Rochester).** Lavender pink... 1/8 oz. 75c. .15
- 850 **Purple.** Deep, rich color..... 1/8 oz. 75c. .15
- 855 **Rose.** Deep, brilliant rose..... 1/8 oz. 75c. .15
- 860 **White.** Immense, pure white..... 1/8 oz. 75c. .15
- 880 **Pacific Beauty.** Light lavender... 1/8 oz. 75c. .20

QUEEN OF THE MARKET. The earliest flowering, first-class Aster. Coming into bloom 3 to 4 weeks earlier than other sorts. The flowers are of good size on long stems and extensively grown for cutting. 1 ft.

- 895 **Collection of the following 6 colors**..... .50
- 900 **Crimson**..... 1/4 oz. 75c., oz. \$2.00 .10
- 905 **Dark Blue**..... 1/4 oz. 75c., oz. 2.00 .10
- 910 **Flesh Pink**..... 1/4 oz. 75c., oz. 2.00 .10
- 915 **Light Blue**..... 1/4 oz. 75c., oz. 2.00 .10
- 920 **Rose**..... 1/4 oz. 75c., oz. 2.00 .10
- 925 **White**..... 1/4 oz. 75c., oz. 2.00 .10
- 930 **Mixed.** All colors... 1/4 oz. 75c., oz. 2.00 .10

- 935 **SENSATION (New Red).** Entirely different from all others, and in a class of its own. It is the reddest of all red Asters, the color being a dark, rich garnet, which glistens in the sunshine. Flowers very double, 3 in. across, and borne freely on long stems. It blooms with the late sorts; branching habit. 1 1/2 ft.... 1/4 oz. \$1.25 .15

- 938 **"SURPRISE SALMON GOLD."** Pure salmon yellow, turning to a radiating salmon pink. Peony type flowers on long stems. Begins blooming in July..... .25

TALL AMERICAN BEAUTY. A fine, strong growing Aster with incurved petals, flower stems 15 to 18 in. long. Blooms with the late varieties.

- 945 **Azure Fairy**..... 1/8 oz. 75c. .20
- 950 **Peach Blossom**..... 1/8 oz. 75c. .20
- 955 **Purple**..... 1/8 oz. 75c. .20
- 960 **Rose**..... 1/8 oz. 75c. .20
- 965 **Shell Pink**..... 1/8 oz. 75c. .20
- 970 **White**..... 1/8 oz. 75c. .20
- 975 **Mixed**..... 1/8 oz. 75c. .20

SINGLE GIANTS OF CALIFORNIA. A new type of single Aster, with flowers measuring 3 to 4 in. across with stems 1 1/2 to 2 ft. in length. The petals are slightly twisted.

- 976 **Delicate Flesh**..... 1/8 oz. 60c. .20
- 981 **Light Blue**..... 1/8 oz. 60c. .20
- 986 **Lilac**..... 1/8 oz. 60c. .20
- 991 **Purple**..... 1/8 oz. 60c. .20
- 996 **Rose**..... 1/8 oz. 60c. .20
- 1001 **White**..... 1/8 oz. 60c. .20
- 1006 **Finest Mixed**..... 1/8 oz. 60c. .20

No. **CALIFORNIA SINGLE GIANT IMPROVED** Pkt.

"SUNSHINE." Crested flowers with golden centers; strong growing with flower stems 2 ft. and over in length.

- 1010 **Carmine**..... 1/8 oz. 85c. \$0.20
- 1012 **Lavender**..... 1/8 oz. 85c. .20
- 1015 **Pink**..... 1/8 oz. 85c. .20
- 1016 **Violet**..... 1/8 oz. 85c. .20
- 1017 **White**..... 1/8 oz. 85c. .20
- 1018 **Mixed**..... 1/8 oz. 85c. .20

SINGLE ASTER ELEGANCE. New, large-flowered single sort, on long stems, with beautiful long petals. 1 1/2 ft.

- 1020 **Deep Rose**..... 1/8 oz. 75c. .10
- 1025 **Deep Blue**..... 1/8 oz. 75c. .10
- 1028 **General Joffre.** Crimson scarlet... 1/8 oz. 75c. .15
- 1030 **Lavender**..... 1/8 oz. 75c. .10
- 1035 **Pink**..... 1/8 oz. 75c. .10
- 1040 **White**..... 1/8 oz. 75c. .10
- 1045 **Mixed**..... 1/8 oz. 75c. .10

ASTER, Perennial Sorts (Michaelmas Daisies).

We have in this class some of the most showy, beautiful and interesting hardy plants grown; their graceful habit, profusion of bloom and great variety of color form the chief attraction of the flower garden throughout the Autumn months.

- 1050 **alpinus speciosus.** Large, rich purple..... .25
- 1055 **subcoeruleus.** Very large, mauve-colored, orange-centered flowers, 2 to 3 in. across, long stems. Quite early. 2 ft..... .25
- 1060 **White Queen.** Large white..... .25
- 1065 **Mixed Hybrids, New, Large-flowered.** This strain contains many beautiful colors, and the flowers are produced in great profusion. 2 to 4 ft..... 1/4 oz. \$1.75 .25



American Beauty Aster



Single Begonia, Tuberous-rooted

No.		Pkt.
	AUBRIETIA. These dwarf, hardy perennials are invaluable for the border, rockeries, etc.; they are among the brightest and most free flowering plants of early Spring.	
1070	<i>græca.</i> Beautiful purple color.....	\$0.25
1075	<i>leichtlini.</i> Rosy red, very pretty.....	.25
	AURICULA. See <i>Primula auricula.</i>	
	BACHELOR BUTTON. See <i>Centaurea.</i>	
	BALSAM. These old-fashioned annuals so easily grown are again increasing in popularity, and most beautiful and brilliant effects may be had from them; overcrowding should be avoided and they should be set at least 18 inches apart for best results.	
1080	Columbia Prize. An unsurpassed strain in doubleness, size, brilliancy and variety of color.....	¼ oz. 75c. .15
1085	Dark Blood Red. Extra.....	¼ oz. 50c. .10
1090	Intense Scarlet (The King).....	¼ oz. 50c. .10
1095	Rich Pink (Salmon King).....	¼ oz. 50c. .10
1100	White (Snowball). Superior.....	¼ oz. 50c. .10
1105	Mixed Rose-flowered. Very double.....	¼ oz. 40c. .10
1110	BALLOON VINE. A rapid growing annual climber, with white flowers and inflated seed vessels which look like miniature balloons.....	Oz. 50c. .10
1115	BAPTISIA australis (False Indigo). Handsome hardy perennial, producing bright blue, pea-shaped flowers on spikes 6 inches long. 2½ ft.....	¼ oz. \$1.00 .15
1120	BARTONIA aurea. Showy, hardy annual of distinct character, its large, golden yellow flowers being freely produced; succeeds well in partial shade. 1½ ft.....	¼ oz. 50c. .15

No.		Pkt.
	BEANS, Flowering. Popular ornamental climbers, with edible pods of delicious flavor. 6 to 8 ft.	
1125	Butterfly Runner. Large pink and white. ¼ lb. 50c., lb. \$1.50	\$0.15
1130	Scarlet Runner. Large, brilliant scarlet. Lb. 45c.	.10
1135	White Runner. Large, pure white. Lb. 45c.	.10
	BEGONIA, Tuberous-rooted. These are easily grown from seed and may be had in bloom in about 6 months. They make a gorgeous display throughout the season and are excellent for bedding purposes, window boxes, etc., and as pot plants are effective for house and conservatory. 1 ft.	
1140	Double, Prize Mixed	1.00
1145	Single, Giant Mixed50
1150	Single Fringed. Unsurpassed strain.....	.50
	BEGONIA, Fibrous-rooted. The following sorts are perpetual bloomers and extensively used for planting outside in beds and for pot culture in the greenhouse. 1 ft.	
1155	gracilis alba. Pure white.....	.25
1160	Bonfire. Lustrous carmine, with brownish red foliage.....	.25
1165	Mignon. Brilliant salmon scarlet. 8 in.	.25
1170	luminosa. Dark scarlet, foliage deep...	.25
1172	Prima Donna. Rose, carmine shaded...	.25
1175	rosea. Fine rose pink.....	.25
1180	erfordi. Lovely rosy carmine flowers, with dark, glossy, green foliage.....	.50
1183	Mariemont Bedder. Scarlet blooms, reddish brown foliage.....	.25
1185	Salmon Queen. Brilliant salmon red, passing to salmon rose; the dark green foliage has a reddish hue.....	.50
1190	Triumph. Beautiful, large, snow white flowers; excellent.....	.50
1195	Vernon. Deep scarlet, with bronze foliage.	.25
1200	Vernon, Dwarf. Rich red, with glossy bronze foliage. 8 in.....	.25
1205	Rex varieties, Mixed (Ornamental leaved). Large, handsomely variegated leaves....	.75
	BELLIS perennis fl. pl. (Double Daisy). Favorite perennials producing in Spring their handsome, double flowers, and are very effective when planted with Pansies or Forget-me-nots. Rich soil and cool situation suit them best.	
1210	Longfellow. Large dark rose... ¼ oz.	\$2.00 .15
1215	Snowball. Large, pure white... ¼ oz.	\$2.00 .15
1220	monstrosa Rose. Extra large. ⅛ oz.	\$1.50 .25
1225	monstrosa White. Extra large. ⅛ oz.	\$1.50 .25
1230	Quilled, Giant Red. Dark red.....	.25
1235	Quilled, Giant White. Pure white.....	.25
1240	Finest Mixed. Double..... ⅛ oz.	\$1.00 .15
	BELVIDERE. See <i>Kochia.</i>	
1245	BOCCONIA japonica (Plume Poppy, or Tree Celandine). Ornamental, hardy perennial, with glaucous green foliage and spikes of creamy white flowers, 2 to 3 feet long; grown in clumps or as single specimens, they produce a marked effect. 5 ft.....	¼ oz. 60c. .15
1250	BOLTONIA latisquama. One of our showiest hardy perennials, with large clusters of lavender-pink, Daisy-like flowers. 5 ft.	.25
	BROWALLIA. Beautiful, profuse blooming bedding and pot plants. 1½ to 2 ft.	
1255	speciosa major. Large, brilliant, ultramarine blue; splendid Winter bloomer...	.35
1256	White, same habit as above.....	.50
1260	Mixed. Shades of blue and white. ¼ oz.	50c. .15

No.		Pkt.
	BRUGMANSIA. See <i>Datura arborea</i> .	
1265	BUPHTHALMUM salicifolium (Ox-Eye). Fine, hardy perennial, with large, golden yellow flowers on long stems, 2 ft. ¼ oz. 85c.	\$0.15
	BRACHYCOME (Swan River Daisy). Pro- fuse flowering, low growing annual, with pretty Daisy-like flowers; doing best in warm and dry situations. 9 in.	
1270	Blue Star. Beautiful bright blue. ⅛ oz. 50c.	.15
1275	rosea. Fine rose color. ¼ oz. 75c.	.15
1280	Mixed. Shades of blue, white and rose. ¼ oz. 50c.	.10
1285	CACALIA coccinea (Tassel Flower). A neat, free blooming annual, with scarlet tassel- like flowers. All Summer. 1½ ft. ¼ oz. 35c.	.10
1290	CACTUS, Mixed Varieties. Succulent plants of curious and ornamental growth, with showy flowers. Tender perennials.25
	CALCEOLARIA. Our seeds are from noted English growers and saved from the finest strains grown, which have been awarded the leading prizes.	
1295	Covent Garden Strain. Extra choice, strongly recommended for habit, size and marking of flowers.75
1300	KELWAYS Perfect Model. Of splendid habit, neither too tall nor too dwarf; large heads of very large flowers, which are well rounded and filled out, the richest and most delicate colors in the most wonder- ful variety of shades and markings.	1.00
1305	rugosa, or Shrubby, Mixed. Choice bed- ding varieties, with innumerable flowers. . .	.50
	CALENDULA officinalis fl. pl. (Pot Mari- gold). Valuable, hardy annual, the double showy flowers making a grand display for months; suitable for dry places. 1 ft.	
1308	Campfire (Sensation). Dark orange. ¼ oz. \$1.00	.25
1318	Ball's Orange, light center. Oz. \$2.00	.15
1319	Ball's Gold, deep golden. Oz. \$2.50	.15
1310	Lemon Queen. Lemon yellow. Oz. \$1.00	.15
1315	Meteor. Lemon, striped with orange. Oz. 50c.	.10
1320	Orange King. Large, dark orange. Oz. \$1.00	.15
1330	Mixed. Shades of lemon and orange. Oz. 35c.	.10
	CALIFORNIA POPPY. See <i>Eschscholtzia</i> .	
	CALLIOPSIS, or COREOPSIS. Remark- able, showy, hardy annuals, very contin- uous in flowering, hardly anything surpass- ing them in this respect, and most useful for cutting. 1½ to 2 ft.	
1335	coronata maxima. Large yellow. ¼ oz. 40c.	.10
1340	drummondii (Golden Wave). Golden yel- low, with brown center. ¼ oz. 40c.	.10
1345	Fire King. Deep, bright scarlet, cactus- shaped petals.15
1351	Nana. "The Garnet" Dwarf; glossy crimson scarlet; 15 to 18 inches15
1355	Mixed. Fine varieties. ¼ oz. 25c., oz. 75c.	.10
1360	Mixed Double (Hybrida fl. pl.) . . ¼ oz. 35c.	.10
	CALLIOPSIS, or COREOPSIS. Hardy Per- ennial Varieties. Early sown seed will bloom the same season, but it is better to sow in July and protect lightly in Winter.	
1365	Mayfield Giant. Cantornia strain. Large golden yellow flowers. ¼ oz. \$1.00	.25
1370	grandiflora. Bright, golden yellow. ¼ oz. 50c.	.10
1375	lancelota. Large, bright yellow. ¼ oz. 60c.	.15
1380	CALLIRHOE involucrata (Poppy Mallow). Showy, hardy perennial of spreading growth, with large, bright crimson, saucer- shaped flowers from early Summer till Fall. 1 ft. ¼ oz. 60c.	.15

No.		Pkt.
	CAMPANULA (Bellflower). Beautiful, well- known hardy perennial and one of our most attractive garden flowers, noted for their rich colors and profusion of bloom.	
1385	carpatica. Erect blue flowers all Summer; useful for borders or rockery. 9 in. ¼ oz. \$1.00	\$0.15
1390	carpatica alba. Erect, white flowers. 9 in. ¼ oz. \$1.00	.15
1395	mirabilis. Large, pale blue; extra. 2 ft.	.50
1400	moerheimi. Large, white, saucer-shaped flowers. 2 ft. ⅛ oz. \$1.50	.25
1405	persicifolia grandiflora. Large, bright blue; one of the best. 2 ft. ⅛ oz. 85c.	.25
1410	persicifolia grandiflora alba. Large, pure white. 2 ft. ⅛ oz. 85c.	.25
1415	persicifolia grandiflora pfitzeri. Large, light blue, double and semi-double. 2 ft. . .	.25
1420	persicifolia, Mixed. All shades of blue and white. 2 ft. ⅛ oz. 85c.	.25
1425	pyramidalis (Chimney Bellflower). Blue, 4 ft. ⅛ oz. 60c.	.15
1430	alba. White. 4 ft. ⅛ oz. 75c.	.15
1433	compacta Mixed. Much more dwarf and free blooming than preceding15
	CAMPANULA medium (Canterbury-bells). Showy, hardy biennials, about 3 ft. high, of pyramidal form, and profusely covered with large, bell-shaped flowers.	
	calycanthema (Cup-and-saucer Varieties).	
1440	Blue. ¼ oz. \$1.00	.15
1445	Rose Pink. ¼ oz. 1.00	.15
1450	White. ¼ oz. 1.00	.15
1455	Mixed. All colors. ¼ oz. 1.00	.15
1457	Double Mixed.35
1460	Single, Blue. ¼ oz. 50c.	.10
1465	Rose Pink. ¼ oz. 50c.	.10
1470	Reddish Violet. ¼ oz. 50c.	.10
1475	Mauve. ¼ oz. 50c.	.10

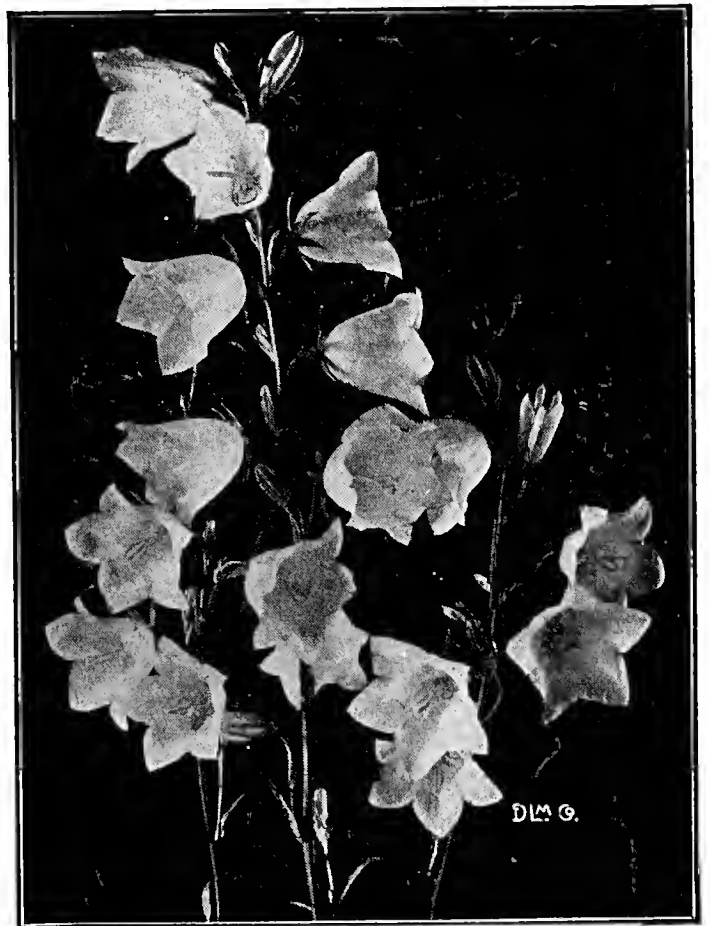

Campanula persicifolia

No.		Pkt.
CAMPANULA medium —Continued.		
1480	Single White	1/4 oz. 60c. \$0.10
1485	Mixed . All colors.....	1/4 oz. 60c. .10
1490	Double, Blue	1/4 oz. \$1.00 .15
1495	Rose Pink	1/4 oz. 1.00 .15
1500	White	1/4 oz. 1.00 .15
1505	Mixed . All colors.....	1/4 oz. 1.00 .15
1510	Columbia Prize Mixture . All colors of all varieties, unsurpassed.....	1/4 oz. \$1.00 .25
CANARY BIRD VINE . See Tropaeolum .		
CANDYTUFT . Fine for edgings and cut flowers. 1 ft.		
1515	Carmine . Carmine rose. 1/4 oz. 40c., oz. \$1.50	.15
1520	Crimson	1/4 oz. 25c., oz. 75c. .15
1525	Dobbies White Spiral . A superior strain of the large flowered white from the introducer.....	1/4 oz. 50c., oz. \$1.50 .10
1530	Empress . Immense, pure white, pyramidal trusses.....	1/4 oz. 35c., oz. \$1.00 .10
1532	Flesh Pink	1/4 oz. 40c. .10
1535	Giant Perfection . Immense, pure white spikes. Special selection 1/4 oz. 60c., oz. \$2.00	.15
1537	Pyramidal Perfection . Very large, white, fine for greenhouses.....	1/4 oz. 60c. .15
1540	Purple . Fine shade.....	1/4 oz. 20c., oz. 50c. .10
1542	Rose Cardinal	1/4 oz. 50c. .15
1545	Mixed . All colors.....	1/4 oz. 15c., oz. 40c. .10
1550	Dwarf Rose	1/4 oz. 60c., oz. \$1.75 .15
1555	White	1/4 oz. 60c., oz. 1.75 .15
1556	Flesh Pink	1/4 oz. 60c. .15
1558	Crimson	1/4 oz. 60c. .15
1560	Mixed Hybrids	1/4 oz. 50c., oz. \$1.50 .10

CANNAS . Handsome foliage. Soak the seed in hot water 24 hours before sowing. 3 to 4 ft.		
1565	Crozy's New Large-Flowering Varieties . Newest and best sorts.....	Oz. 60c. .10
1570	Dark-leaved Sorts	Oz. 75c. .10

CARDINAL CLIMBER. See **Ipomoea Quamoclit**.

CARNATION PINKS. See **Dianthus**.

CASTOR OIL BEANS. See **Ricinus**.



Celosia childsi



Candytuft, Giant Perfection

No.		Pkt.
CATCHFLY . See Silene .		
CELOSIA cristata , or COCKSCOMB . Free blooming annuals; large, brilliant Cockscomb-like heads. They prefer a light soil, not too rich; fine border or pot plant.		
1575	Collection 5 following colors, separate ..	\$0.60
1580	Dwarf Bright Rose . 3/4 ft.....	1/8 oz. \$1.00 .15
1585	Copper Color . 3/4 ft.....	1/8 oz. 1.00 .15
1590	Dark Blood Red . 3/4 ft.....	1/8 oz. 1.00 .15
1595	Glasgow Prize . Dark crimson. 3/4 ft. 1/8 oz. 1.25 .15	
1600	Golden Yellow . 3/4 ft.....	1/8 oz. 1.00 .15
1610	Mixed . Finest colors. 3/4 ft.....	1/8 oz. .75 .10
1615	Tall Mixed . All colors. 2 to 3 ft. 1/8 oz. .20 .10	

CELOSIA thompsoni magnifica, **Improved Feathered Cockscomb**. A magnificent and valuable annual, with long, feathery plumes of the richest colors, varying from pale yellow to the deepest crimson. Effective during Summer and Fall. 2 ft.

1617	childsi (Chinese Woolflower).....	.15
1620	Carmine	1/8 oz. 50c. .15
1625	Crimson	1/8 oz. 50c. .15
1630	Golden Yellow	1/8 oz. 50c. .15
1635	Light Yellow	1/8 oz. 50c. .15
1640	Scarlet	1/8 oz. 50c. .15
1645	Triumph of Exposition . Crimson, dark red stems.....	1/8 oz. 50c. .15
1650	Mixed . All colors.....	1/8 oz. 50c. .15

1660 **CELSIA arcturus**. A fine, half hardy plant, very pretty for pot culture in a cool house. The long spikes of bright yellow flowers are produced the same season from Spring sown seed..... .50

CENTAUREA (Dusty Miller). Silver foliaged plants, extensively used for edgings, baskets, etc. Half-hardy perennial.

1665	candidissima . Thick foliage. 1 ft. 1/8 oz. 50c.	.15
1670	gymnocarpa . Very graceful. 1 1/2 ft. 1/4 oz. 50c.	.15

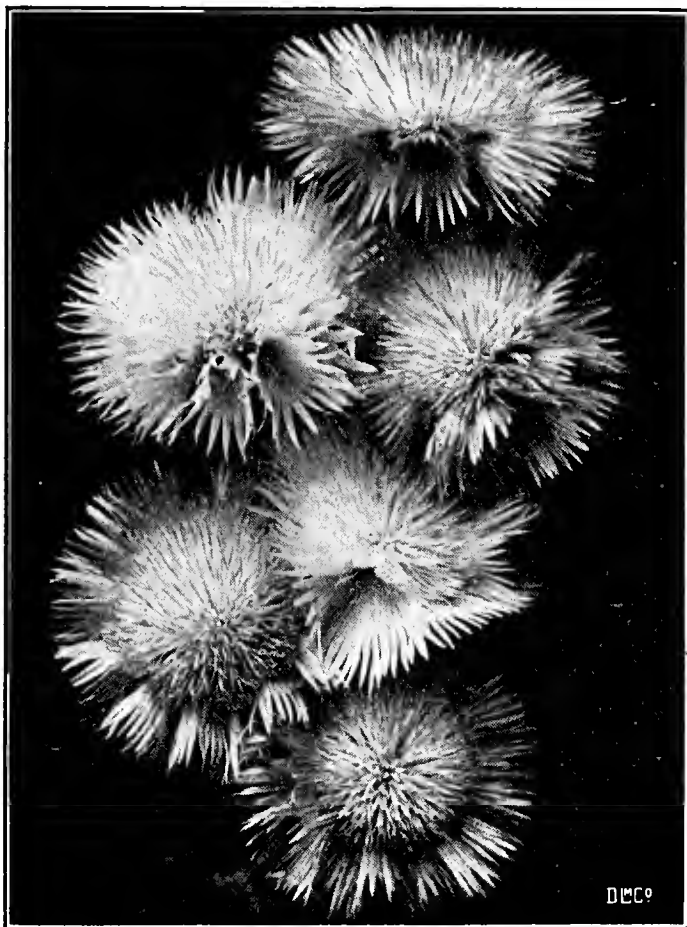

Centaurea imperialis

- | No. | | Pkt. |
|------|--|----------------|
| | CENTAUREA, Annual Varieties. Very free flowering, with handsome, showy flowers; useful for cutting. 1½ to 2 ft. | |
| 1675 | americana. Large, reddish lilac. ¼ oz. | 60c. \$0.15 |
| 1680 | cyanus, Mixed (Bachelor Button)... | oz. 60c. .10 |
| 1685 | Double, Mixed | oz. \$1.00 .10 |
| 1690 | Single Blue | oz. 60c. .10 |
| 1695 | Double Blue | ¼ oz. 60c. .15 |
| 1696 | Double Carmine | ¼ oz. 50c. .15 |
| 1698 | Double Mauve | ¼ oz. 50c. .15 |
| 1700 | Double Purple | ¼ oz. 50c. .15 |
| 1705 | Double Rose | ¼ oz. 50c. .15 |
| 1710 | Double White | ¼ oz. 50c. .15 |
| | imperialis (Royal Sweet Sultan). Very large, sweet scented flowers, on long stems, 2 to 3 ft. | |
| 1715 | Bright Pink | ¼ oz. 60c. .15 |
| 1720 | Dark Purple | ¼ oz. 60c. .15 |
| 1725 | Deep Lavender | ¼ oz. 60c. .15 |
| 1730 | Lilac | ¼ oz. 60c. .15 |
| 1735 | White | ¼ oz. 60c. .15 |
| 1740 | Mixed. All colors..... | ¼ oz. 60c. .15 |
| 1745 | moschata (Sweet-sultan). Purple. | ¼ oz. 20c. .10 |
| 1748 | Rose | ¼ oz. 20c. .10 |
| 1755 | White | ¼ oz. 20c. .10 |
| 1760 | Mixed | ¼ oz. 20c. .10 |
| 1765 | suaveolens. Yellow Sweet-sultan. | ¼ oz. 50c. .15 |
| | CENTAUREA, Perennial Varieties. Desirable, hardy plants, with showy thistle-like flowers from July to September. | |
| 1770 | macrocephala. Large yellow. 3 ft..... | .15 |
| 1775 | montana. Deep purple. 2 ft.... | ¼ oz. 75c. .15 |
| 1780 | alba. Large white. 2 ft..... | ¼ oz. 75c. .15 |
| 1785 | rosea. Rose pink. 2 ft..... | .25 |
| 1790 | CERASTIUM tomentosum (Snow-in-summer). A white foliated hardy perennial, with small, white flowers; fine for edgings and rockeries. 4 in..... | ⅛ oz. 75c. .25 |

- | No. | | Pkt. |
|------|---|-------------------|
| 1792 | CHEIRANTHUS allioni (Siberian Wallflower). Excellent dwarf perennial for rocky or margin of herbaceous border, brilliant orange flowers in Spring and all Summer if seed pods are removed..... | ¼ oz. 75c. \$0.20 |
| 1794 | linifolius (Alpine Wallflower). Dwarf, Mauve, fragrant. 1 ft..... | .25 |
| | CHELONE. Very handsome plant, with Pentstemon-like spikes of brilliant colored flowers from July to October. Hardy perennial. 2 ft. | |
| 1795 | barbata torreyi. Scarlet..... | ⅛ oz. 75c. .15 |
| 1800 | Hybrid, Finest Mixed. Beautiful..... | ⅛ oz. 60c. .15 |
| | CHRYSANTHEMUM. Showy and effective Summer flowering plants, blooming from July until frost; very desirable for the garden and for cut flowers. | |
| | Double-flowering Annual Varieties. 2 ft. | |
| 1805 | Golden yellow | ¼ oz. 60c. .15 |
| 1810 | White | ¼ oz. 60c. .15 |
| 1815 | Mixed. All colors..... | ¼ oz. 40c. .10 |
| 1820 | Fringed Hybrids. All colors..... | ¼ oz. 50c. .15 |
| | Single-flowering Annual Varieties. 2 ft. | |
| 1825 | atrococcineum. Scarlet..... | ¼ oz. 35c. .10 |
| 1830 | Evening Star. Large golden... ¼ oz. | 60c. .10 |
| 1835 | Morning Star. Large primrose ¼ oz. | 60c. .10 |
| 1840 | Northern Star. Large white, yellow center, with dark disc..... | ¼ oz. 60c. .10 |
| 1845 | Mixed. All colors..... | Oz. 60c. .10 |
| 1850 | Grey's Special Mixture. All colors in double, single and fringed..... | ¼ oz. 60c. .15 |
| | CHRYSANTHEMUM, Perennial Varieties. Of great value in the garden and conservatory, blooming from early Autumn to December. | |
| 1855 | frutescens (Paris Daisy). Single white, fine for Winter blooming. 1½ ft. ¼ oz. | 60c. .15 |
| | SEE PAGE IV for SEEDS OF PLANTS SUITABLE for ROCK GARDEN | |
| 1870 | Shasta Daisy (Alaska). One of the best hardy white flowers for cutting; large, single | .25 |
| 1875 | Pompon-flowered. The double, small-flowered hardy sorts; fine colors..... | .25 |

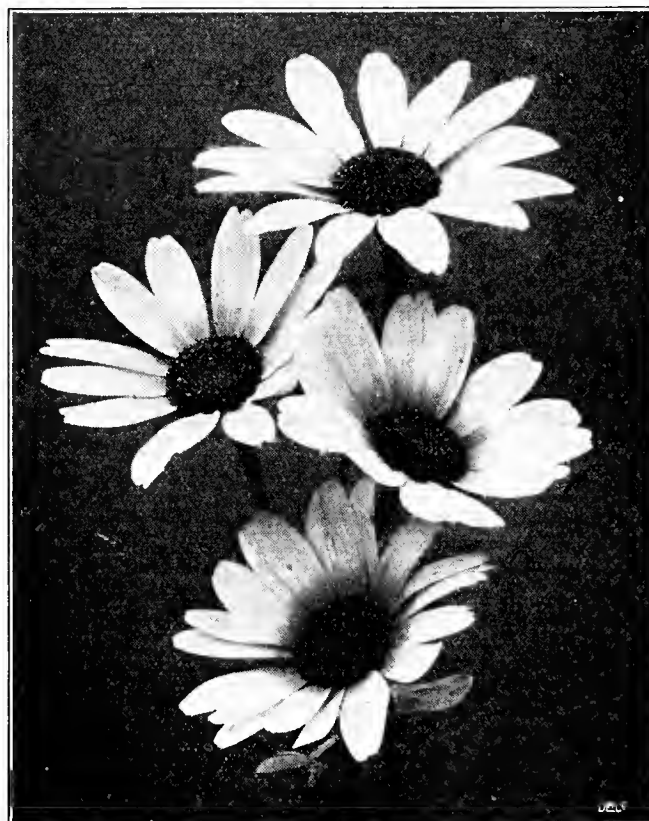

Annual Chrysanthemum Morning Star

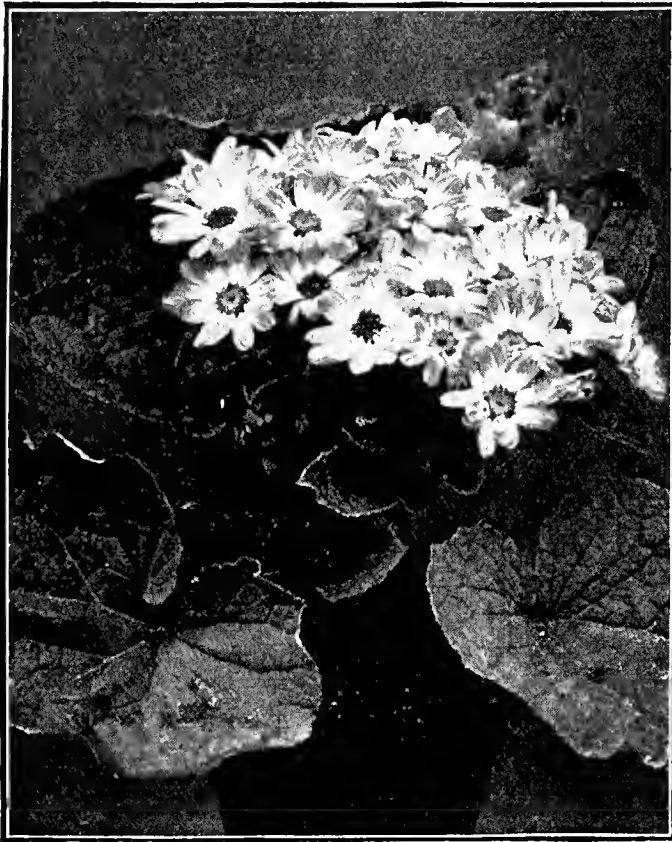

Cineraria, Grey's Exhibition Prize

No.		Pkt.
	CINERARIA. One of the most beautiful plants that can be grown for decorative purposes. Seed should not be sown too soon. Sown in June or July, plants large enough for all purposes can be had; the aim should be to secure as hard a growth as possible.	
1880	Grey's Exhibition Prize. Acknowledged by our customers to be the finest strain grown; of compact branching habit, with exceptionally large flowers of the richest and brightest colors.....	\$1.00
1885	grandiflora alba. Large pure white.....	.75
1890	atrosanguinea. Large blood red.....	.75
1895	azurea. Large, light blue.....	.75
1898	Dark Blue.75
1900	kermesina. Large, bright crimson.....	.75
1902	Matador. Glowing scarlet.....	.75
1905	Pink Shades. Very fine.....	.75
1910	Dwarf Large-flowering Mixed. Dwarf, compact habit with immense trusses of large flowers in rich colors.....	.75
1919	stellata, Feltham Beauty. Extra mixed..	.75
1920	stella grandiflora. Large flowers, with twisted or fluted petals like the single Cactus Dahlia.....	.75
1925	maritima candidissima (Dusty-miller). White foliage for borders.....	¼ oz. 35c. .15
	CLARKIA. Very showy and profuse flowering hardy annuals of easy culture; very useful for cutting.	
1928	Double Apple Blossom.	¼ oz. 50c. .15
1930	Brilliant. Bright orange.....	¼ oz. 50c. .15
1935	Orange King. Orange scarlet.....	¼ oz. 50c. .15
1940	Purple Prince. Rich purple.....	¼ oz. 50c. .15
1945	Queen Mary. Rose carmine.....	¼ oz. 50c. .15
1950	Salmon Queen. Salmon pink.....	¼ oz. 50c. .15
1952	White.	¼ oz. 50c. .15
1955	Mixed. Extra fine colors.....	¼ oz. 25c. .10
1960	Single Mixed. All colors.....	oz. 50c. .10

No.		Pkt.
	CLEMATIS. Well known as valuable, hardy, profuse flowering, climbing perennials. Seed sown in coldframe or border will germinate freely the next Spring.	
1965	Jackman's New Hybrids. Elegant large-flowered sorts, and when raised from seed afford a wide range of color... ¼ oz.	\$1.00 \$0.25
1970	paniculata. Vigorous grower and covered in Autumn with a cloud of star-like, fragrant white flowers.....	¼ oz. 35c. .10
1975	CLEOME pungens (Spiderflower). An attractive annual rose.....	¼ oz. 75c. .15
1976.	alba. White.....	⅛ oz. 50c. .15
1980	CLIANTHUS dampieri (Glory Pea). A magnificent greenhouse annual, with large, brilliant scarlet, pea-shaped flowers having a black center.....	.25
	CLOVE PINKS. See Dianthus.	
1985	COBAEA scandens. Popular half hardy, climbing perennial of rapid growth, with large, purple, bell-shaped flowers; blooming first season from seed which should be planted edgewise. 20 ft. ¼ oz.	30c., oz. \$1.00 .15
1990	scandens alba. White flowered.....	.25
1993	Mixed Purple and White.	¼ oz. 30c., oz. \$1.00 .10
	COCKSCOMB. See Celosia.	
2001	COLCHICUM autumnale (Meadow Saffron, or Fall-blooming Crocus). Bulbous perennial.....	⅛ oz. 35c. .10
	COLEUS. Ornamental foliage plants, easily grow from seed. Half hardy perennial.	
2005	Mixed Hybrids. From a large collection.	.15
2010	New Large-leaved Varieties. Extra fine.	.25
2015	COLLINSIA, Mixed. Free flowering, hardy annuals of deserved popularity, blooming from June to October, and suited to dry situations.....	¼ oz. 20c. .10
	COLUMBINE. See Aquilegia.	
2020	COMMELINA coelestis. Half hardy tuberous-rooted perennial, with-sky-blue flowers; blooms first season. 1½ ft.....	.15



Double Clarkia Salmon Queen

No. 2025 **CONVOLVULUS minor, Mixed.** Handsome, hardy annual, with large, richly colored flowers, producing a brilliant effect. 1 ft. Oz. 40c. \$0.10 Pkt

major. See *Ipomoea*.

COSMOS. One of the most beautiful and useful of the hardy annuals, producing through the season thousands of beautiful flowers. Seed should be sown in May in the open ground. The early varieties will bloom from July till frost. 4 to 6 ft.

Double Crested. Early blooming. A large per cent coming true.

- 2026 **Carnelia.** Crimson..... $\frac{1}{4}$ oz. \$1.00 .25
- 2027 **Peach Blossom.** Pink..... $\frac{1}{4}$ oz. 1.00 .25
- 2028 **Whirlwind.** White..... $\frac{1}{4}$ oz. 1.00 .25
- 2029 **Finest Mixed**..... $\frac{1}{4}$ oz. 1.00 .25

2030 **Extra Early, Mammoth Midsummer, Mixed.** The blossoms, under ordinary field cultivation, average 4 to 5 inches across, surpassing in size any of the late varieties. $\frac{1}{4}$ oz. 85c. .15

From seed sown in the open ground, the **White** blossoms in exactly 60 days, the **Pink** in 65 days, and the **Crimson** in 70 days.

- 2035 **White.** 4 ft..... $\frac{1}{4}$ oz. 75c., oz. \$2.50 .15
 - 2040 **Pink.** 4 ft..... $\frac{1}{4}$ oz. 75c., oz. \$2.50 .15
 - 2045 **Crimson.** 4 ft..... $\frac{1}{4}$ oz. 75c., oz. \$2.50 .15
- Mammoth.** Late flowering. 5 ft.
- 2055 **Crimson**..... $\frac{1}{4}$ oz. 50c. .10
 - 2060 **Lady Lenox.** Shell pink..... $\frac{1}{4}$ oz. 75c. .15
 - 2065 **Lady Lenox.** White..... $\frac{1}{4}$ oz. 75c. .15

2085 **CUPHEA platycentra** (Cigar Plant). Dwarf, half hardy perennial, with bright scarlet, tubular flowers, tipped with black; blooms freely from seed. Fine pot plant. 1 ft.... .25

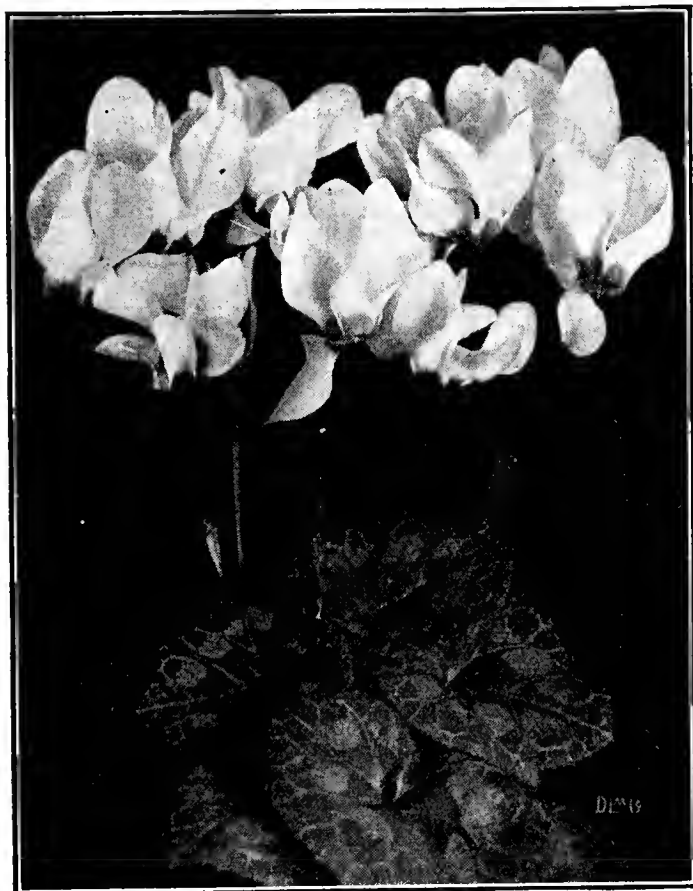

Cyclamen, Grey's Giant White

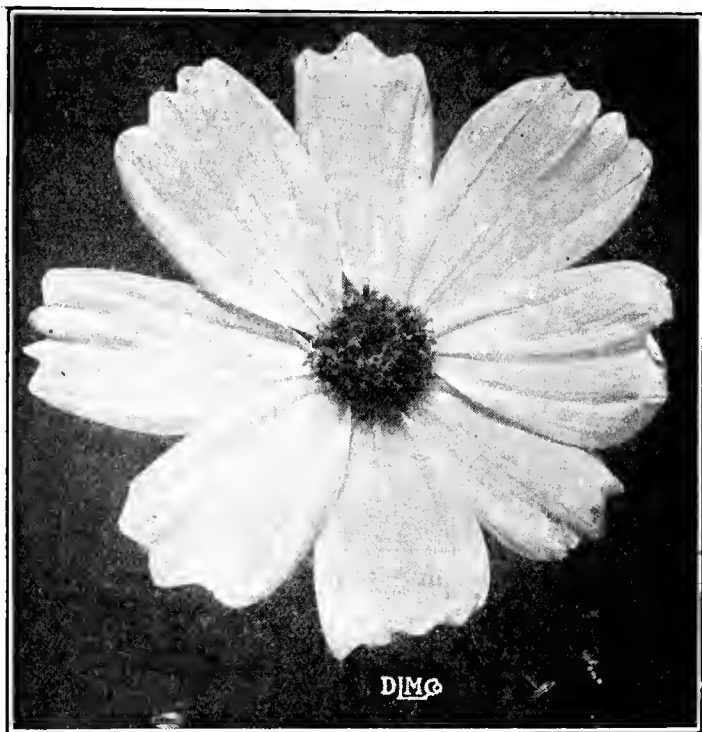

Cosmos

No. **CYCLAMEN.** The seed we offer is saved by Pkt.

a leading specialist from selected strains of the very best varieties, and cannot fail to produce flowers of the largest size, finest substance and most charming shades of color. July to August is the best time for sowing. Seedlings should be grown on without any check whatever, and when grown cool the results are more satisfactory.

- 2090 **Grey's Giant Crimson**.....\$0.75
- 2095 **Grey's Giant Pink**......75
- 2100 **Grey's Giant Salmon**......75
- 2105 **Grey's Giant White**......75
- 2110 **Giant Blood Red**......75
- 2111 **Bonfire**......75
- 2112 **Bush Hill Pink**......75
- 2138 **Lavender.** Self color, very large..... 1.00
- 2142 **Pink Pearl.** Large, pale salmon..... 1.00
- 2143 **Perle of Zehlendorf.** Deep salmon..... .75
- 2150 **Pure Rose.** Rich color......75
- 2152 **Rose of Marienthal.** Pink, red eye..... .75
- 2157 **Rose of Zehlendorf.** Light salmon..... .75
- 2160 **Saffron.** Red...... 1.00
- 2165 **White, Carmine Eye**......75
- 2180 **Grey's Giant Mixture.** All colors..... .75

For above named Cyclamen, 100 seeds \$2.50, 1000 seeds \$18.00

- 2181 **CYCLAMEN, European.** Hardy wild Cyclamen of Switzerland50
- 2182 **CYNOGLOSSUM amabile** (Chinese Forget-me-not). Annual of easy culture. Heavenly blue. 18 in.20
- 2184 **Amabile Pink.** Habit same as the preceding. .35
- 2185 **CYPERUS alternifolius** (Umbrella Plant). Numerous erect stems, supporting in an umbellate manner a quantity of glossy, long, narrow leaves; excellent for house or greenhouse. 1 ft.25
- 2190 **Papyrus** (Egyptian Paper Plant). Palmlike foliage; an aquatic or for pots. 5 ft.25

CYPRESS VINE. See *Impomea quamoclit*.

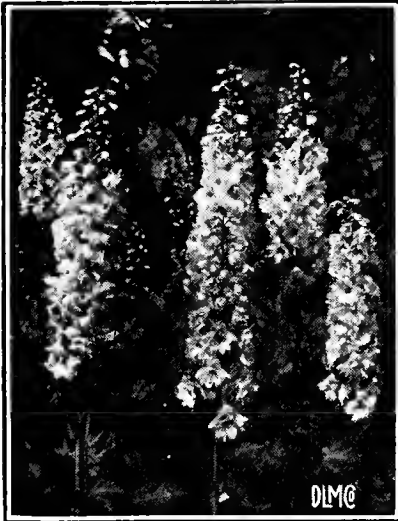

Delphinium, Wrexham Hybrids



Pompon Dahlias



Annual Delphinium

DAHLIA. This popular flower can be easily raised from seed flowering the same season. Seed should be sown early in gentle heat. Half-hardy perennial. 4 to 6 ft.

No.		Pkt.
2195	Cactus, Double Mixed. Saved from a fine collection..... 1/4 oz. \$2.00	\$0.25
2200	Peony-flowered Giant. Single and semi-double flowers of enormous size, resembling the Peony..... 1/4 oz. \$2.00	.25
2205	Pompon, Double Mixed. Small flowered..	.25
2210	Show, Double Mixed. Large flowered.....	.25
2215	Single Giant Perfection. Surpassing all others in size and colors..... 1/4 oz. \$1.50	.25

DAISY. See *Bellis perennis*.

DATURA (Trumpetflower). Handsome, hardy annuals of very rapid growth, with large, trumpet-shaped flowers. 3 ft.

2240	Double Mixed. All sorts..... 1/4 oz. 35c.	.15
------	--	-----

DELPHINIUM, Annual Varieties (Larkspur). Among the best of hardy annuals, lasting a long time in flower. The plants should be transplanted or thinned out to avoid overcrowding and to secure the branching habit.

TALL BRANCHING STOCK FLOWERED

2244	Appleblossom Pink 1/4 oz. 50c.	.15
2246	Brilliant Carmine 1/4 oz. 50c.	.15
2248	Dark Blue 1/4 oz. 50c.	.15
2250	Empress. Rose pink..... 1/4 oz. 50c.	.15
2252	La France. Salmon pink..... 1/4 oz. 50c.	.15
2254	Light Blue 1/4 oz. 50c.	.15
2256	Newport Scarlet 1/4 oz. 50c.	.15
2258	White 1/4 oz. 50c.	.15
2260	Mixed 1/4 oz. 50c.	.15
2262	Collection of 6 packets75

DELPHINIUM (Larkspur). Annual varieties.

2264	Giant Imperial Blue Spire20
2266	Giant Imperial Lilac Spire20
2268	Giant Imperial White Spire20
2270	Giant Imperial Exquisite Soft Pink Imp.	.20
2272	Giant Imperial Exquisite Rose20
2274	Giant Imperial Gloria. Rich deep rose....	.20
2276	Giant Imperial Los Angeles. Rose on salmon ground.....	.20

No.		Pkt.
2278	Giant Imperial Peach Blossom. Clear light pink.	\$0.20
2280	Giant Imperial Mixed20
2285	Collection of 6 packets	1.00

2300	Azure Fairy. Clear, light blue. 15 in.....	.25
2301	Blue Gem. Deep blue. 9 to 12 in.....	.15
2305	Blue Butterfly. Bright blue. 15 in..... 1/4 oz. \$1.00	.25

DELPHINIUM, Hardy Perennial Varieties.

From seed they are of easy culture and produce splendid spikes of bloom through the Summer. When sown early they usually bloom in September. 1 to 5 ft.

2310	Columbia Hybrids. An exceptionally fine strain selected from the best large flowering varieties, immense spikes..... 1/4 oz. \$1.50	.25
2312	Blackmore and Langdon's Prize Strain. A world famous strain..... 1-16 oz. \$1.50	.50
2315	Kelway's Show, Mixed. Saved from their celebrated collection of show varieties, which is undoubtedly the largest and finest collection of this popular perennial in existence..... 1-16 oz. \$1.50	.50
2325	Belladonna Improved. Clear turquoise blue; the everblooming, hardy Larkspur; if sown early will bloom in late Summer and Autumn..... 1/8 oz. \$1.25	.25
2326	Belladonna. Deep blue..... 1/8 oz. \$1.25	.25
2333	cashmerianum. Very large, beautiful blue. 1/8 oz. \$1.00	.25
2340	Chinese (grandiflorum). Large, bright gentian blue. 1 1/2 ft..... 1/4 oz. 85c.	.10
2345	Chinese album. Large white.... 1/4 oz. 85c.	.10
2348	Chinese Cambridge Blue. Clear Belladonna blue. 2 to 3 ft.....	.25
2355	elatum (Bee Larkspur). Rich blue with dark centers. 4 ft..... 1/4 oz. 75c.	.15
2360	formosum. Dark blue, white eye. 2 1/2 ft.... 1/8 oz. \$1.00	.25
2365	formosum coelestinum. Light blue. 2 1/2 ft. 1/8 oz. \$1.25	.25
2367	Wrexham Hybrids (Hollyhock Delphinium).	.50
2370	Hybrids, Pale Blue Shades. From newest large flowering sorts..... 1/4 oz. \$1.50	.25
2375	Hybrids, Dark Blue Shades. From new, large flowering sorts..... 1/4 oz. \$1.25	.15



Dianthus, Hardy Carnations

No. **DIANTHUS, or PINKS. Annual Varieties.** Pkt.

These are really hardy biennials though treated as annuals, and bloom the first season from early Summer until frost. They are beautiful border plants and deserve a place in every garden.

DOUBLE-FLOWERING VARIETIES

- 2385 **chinensis, Mixed.** Indian pink. 1/4 oz. 40c. \$0.10
 - 2390 **diadematus, Mixed.** Diadem pink. 1/4 oz. \$1.00 .15
 - 2395 **heddewigi, Mixed.** Japan pink. 1/4 oz. 60c. .10
 - 2400 **laciniatus, Mixed.** Lace pink. 1/4 oz. 60c. .10
 - 2405 **latifolius, Mixed.** Large flowers, resembling the Sweet-william in shades of rose, crimson and maroon. 1/4 oz. 75c. .10
 - 2410 **nobilis, Mixed** (Royal Pink). Largest size and brightest colors. 1/4 oz. 50c. .10
 - 2415 **Blood Red.** Deep color; extra. 1/4 oz. 75c. .10
 - 2420 **Mourning Pink.** Deep crimson, white edge. 1/4 oz. 75c. .10
 - 2425 **Salmon Pink** (Salmon King). 1/4 oz. \$1.00 .20
 - 2430 **White.** Very fine variety. 1/4 oz. 75c. .10
- SINGLE-FLOWERING VARIETIES**
- 2435 **Crimson Belle.** Dark red. 1/4 oz. 75c. .10
 - 2440 **The Bride.** White, purple eye. 1/4 oz. 60c. .10
 - 2445 **Vesuvius.** Brilliant scarlet. 1/4 oz. 50c. .10
 - 2450 **Mixed.** Finest colors and sorts. 1/4 oz. 50c. .10

DIANTHUS caryophyllus (Carnation Pink).

- 2455 **Riviera Market** (Giant of Nice). Superior class of perpetual flowered Carnations. .50
 - 2460 **Marguerite, Giant Mixed.** Improved and very large, double-flowered strain of this early flowering Carnation which blooms in four months from time of sowing, and is composed of the best colors. 1/8 oz. \$1.50 .20
 - 2462 **Giant Rose.** 1/8 oz. \$1.50 .20
 - 2465 **Giant Scarlet.** 1/8 oz. \$1.50 .20
 - 2470 **Giant Yellow.** 1/8 oz. \$1.50 .20
 - 2475 **Giant White.** 1/8 oz. \$1.50 .20
- Chabaud's Giant Improved French Carnation.** Half hardy perennial. Seed sown early inside will bloom in six months. Clove-scented.
- 2479 **Cardinal Red** (Sparkler). .25
 - 2481 **Crimson** (Nero). .25
 - 2483 **Flesh Pink.** .25
 - 2491 **Rose Pink** (The Pearl). .25
 - 2492 **Salmon Rose.** .25
 - 2493 **White** (Jeanne Dionis). .25
 - 2496 **Yellow** (Marie Chabaud). .25
 - 2497 **Finest Mixed.** .25

- No. **DIANTHUS deltoides** (Maiden Pink). Beautiful, hardy sort for rockeries, sunken gardens, etc. The flowers are bright pink, small and in abundance from May to Aug. 6 in. 1/4 oz. \$1.50 \$0.15
 - 2505 **deltoides alba.** White flowers. 1/4 oz. \$1.50 .15
 - 2508 **DIANTHUS** (Hardy Carnation) **allwoodi.** A new race of Hardy Pinks, very free flowering and producing about 75 per cent of double flowers. Mixed colors. .50
 - 2520 **scoticus fl. pl. Perfection.** Prize strain of double Scotch or florists' Pinks in finest colors. .50
 - 2524 **Sweet Wivelsfield.** A hybrid of many colors. Seed started inside early will flower outside from early June to November. Seed planted outside in Spring will flower same season. Seed planted outside in July or August will flower early the following Spring. .30
- DIANTHUS plumarius** (Hardy Garden or Clove Pink).
- 2525 **Double Mixed.** Free blooming strain, with double or semi-double flowers of spicy odor; in finest colors. 1/4 oz. \$1.75 .25
 - 2530 **DICTAMNUS, Mixed** (Fraxinella). Very showy, hardy perennial. 1/4 oz. \$1.50 .25
 - 2532 **DIDISCUS coerulea** (Blue Lace Flower). Hardy annual. 1/8 oz. 50c. .15
- DIGITALIS** (Foxglove). Hardy perennials of easy culture, valuable for shrubby borders, woodland walks, partial shady places, and should be more extensively grown. Blooms in June and July. 3 to 4 ft.
- 2535 **gloxiniaeflora, Mixed.** Fine colors, spotted in the throat. 1/4 oz. 50c. .15
 - 2540 **grandiflora.** Light yellow, fine. 1/4 oz. 35c. .10
 - 2545 **Ivery's Spotted.** An extra choice strain of beautifully spotted flowers. 1/4 oz. 50c. .10
 - 2550 **monstrosa, Mixed.** Beautiful colors with one enormous flower at top of spike. 1/4 oz. 75c. .15
 - 2553 **The Shirley.** Giant mixed. 1/4 oz. 85c. .20
 - 2555 **purpurea, Mixed.** All colors. 1/4 oz. 40c. .10
 - 2560 **Red.** 1/4 oz. 50c. .15
 - 2565 **Rose.** 1/4 oz. 50c. .15
 - 2570 **White.** 1/4 oz. 50c. .15

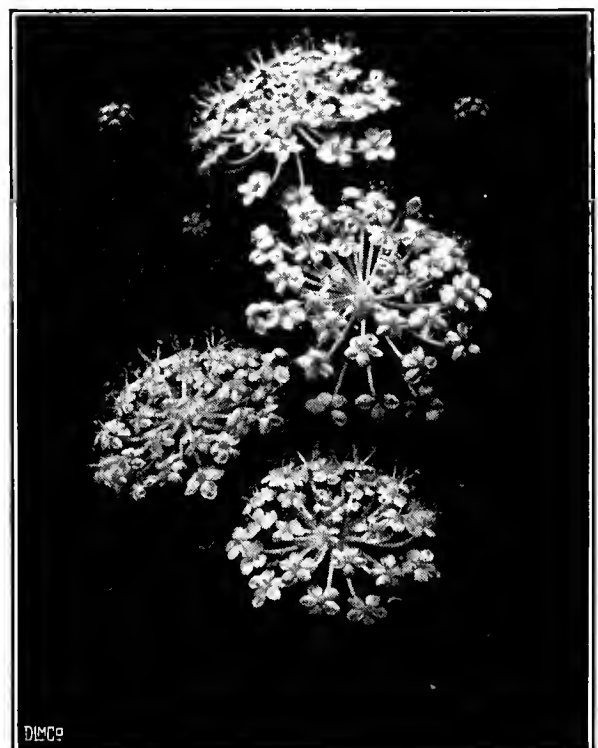

Didiscus coerulea (Blue Lace Flower)

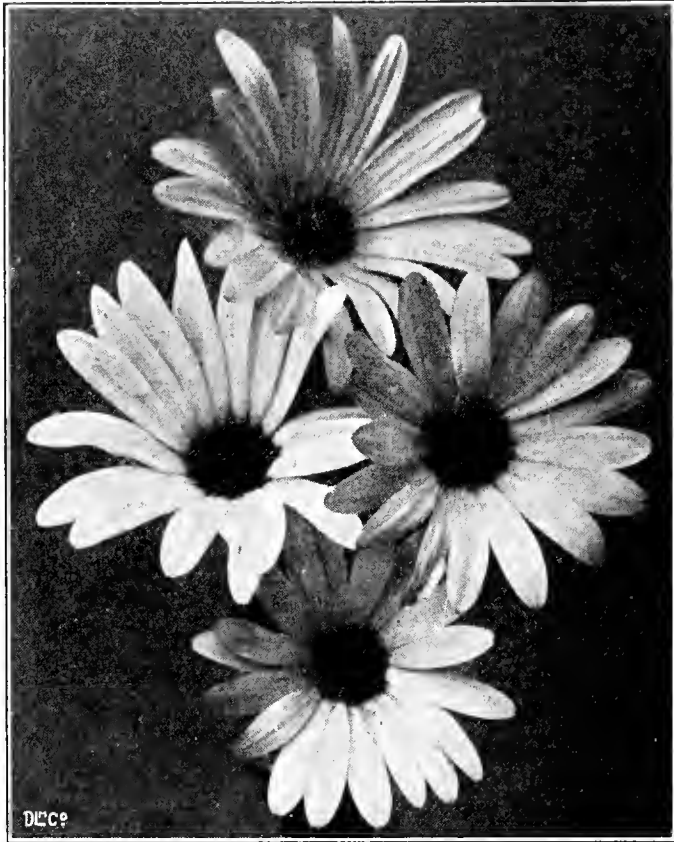

Dimorphotheca

No.		Pkt.
2575	DIMORPHOTHECA aurantiaca (African Marguerite). Beautiful Transvaal annual, with a profusion of rich orange gold flowers throughout the season. 15 in. 1/4 oz. 75c. \$0.15	
2576	Eklonis . Pure white, blue center. 1/8 oz. 75c. .25	
2580	New Hybrids . Rich colors. 1/4 oz. 75c. .15	
	DOLICHOS (Hyacinth-bean). A beautiful, quick growing annual climber; the seed pods are quite ornamental. 10 ft.	
2585	Darkness . Rich purple-violet flowers and purple stems and seed pods. Oz. 40c. .10	
2590	Daylight . Snow white; excellent. Oz. 40c. .10	
2595	lablab, Mixed . Purple and white. Oz. 30c. .10	
	DRACAENA . Decorative plants, with long, graceful foliage; valuable for vases and house decoration; tender perennials.	
2600	australis . Dark green leaves, 2 to 4 in. wide. 1/4 oz. 50c. .15	
2605	indivisa . Narrow green foliage. 1/4 oz. 30c. .10	
2610	Ornamental Foliage Sorts . Including the best and most brilliant colors.25	
2615	DRACOCEPHALUM moldavica . Fine hardy annual, with spikes of violet blue, Salvia-shaped flowers.10	
2620	ECHINACEA helianthus (Red Perennial Sunflower). Large, purplish red flowers freely produced through the whole Summer. 5 ft.15	
2625	purpurea . Large purple, black disc. 3 ft.15	
2630	ECHINOCYSTIS lobata (Wild Cucumber). Rapid growing annual climbers, with ornamental seed pods and large seed. Soak the seed in warm water over night and plant the eye down. 20 ft. Oz. 50c. .10	
2633	ECHINOPS ritro (Globe Thistle). Blue thistle-like flowers, silvery-white foliage.15	
2635	EDELWEISS (Gnaphalium leontopodium). Charming Swiss Alpine plant, with lovely star-shaped, white everlasting flowers.25	

No.		Pkt.
	EREMURUS . Most attractive perennials, bearing in Summer massive spikes; they require rich soil.	
2640	himalaicus . Creamy white. 6 to 8 ft. \$0.25	
2645	robustus . Soft flesh pink. 8 ft.25	
	ERIGERON (Midsummer Daisy). Effective hardy perennial, May to Oct. 1 1/2 ft.	
2650	aurantiacus hybridus . Shades of orange and yellow.25	
2655	speciosus hybridus grandiflorus . Large mauve color; excellent for cutting.15	
2660	ERYNGIUM amethystinum . A handsome, hardy perennial, with beautiful foliage and flowers of a lovely blue. Can be dried for Winter. July, Aug. 3 ft. 1/4 oz. \$1.00 .25	
2665	ERYSIMUM, Golden Gem . Golden yellow hardy biennial, like a miniature Wall-flower, effective for Spring bedding. 3/4 ft. 1/4 oz. 85c. .10	
	ESCHSCHOLTZIA (California Poppy). Profuse flowering plants, with bright, showy flowers; excellent for bedding, massing or ribbon work. Hardy annual. June to Oct. 1 ft.	
2668	Double Autumn Glory . A California Poppy of large size, outside of petals orange crimson, inside a coppery orange; petals also frilled. 1/4 oz. 85c. .20	
2670	aurantiaca . Orange True California Poppy. Oz. 50c. .10	
2675	california alba Oz. 50c. .10	
2680	Carmine King . Deepest carmine. Oz. 75c. .10	
2685	crocea fl. pl. Double orange. Oz. 75c. .10	
2690	Dainty Queen . Delicate pink. Oz. 75c. .10	
2692	Golden West . Yellow, orange center. Oz. 50c. .10	
2695	Mandarin . Inside orange, outside scarlet. Oz. 75c. .10	
2700	maritima . Yellow with orange cross (Cross of Malta). Oz. 50c. .10	
2705	Rose Cardinal . Creamy rose. Oz. 50c. .10	
2708	Tango . Bronzy red overlaid terra cotta. 1/4 oz. 50c. .15	
2709	The Geisha . Fluted petals, orange crimson. 1/4 oz. 50c. .15	
2710	Finest Mixed . All colors. Oz. 50c. .10	
	EUPATORIUM . Free blooming, hardy perennials. Blooms first season from seed. Aug. to Oct.	
2715	ageratoides . Dense heads of small, white flowers. 4 ft. 1/4 oz. 75c. .10	
2720	fraseri . Snow white. 2 ft. 1/8 oz. \$1.00 .25	
2725	EUPHORBIA heterophylla (Mexican Fire-plant). The beautiful orange scarlet bracts completely cover the plant almost the entire season. Annual. 2 to 3 ft. 1/4 oz. 50c. .15	
2730	variegata (Snow-on-the-mountain). Foliage striped and margined with white. Annual. 1 1/2 to 2 ft. Oz. \$1.00 .10	
2735	EXACUM affine . Dwarf, showy, tender annual for pot culture with clusters of fragrant lilac flowers. 1 ft.25	
	FERNS . A well-known, graceful and attractive class of plants.	
2740	Greenhouse Varieties, Finest Mixed25	
2745	Hardy Varieties, Mixed . Finest sorts for outdoor growing.25	
2750	Adiantum cuneatum (Maidenhair Fern).25	
	FEVERFEW . See <i>Matricaria</i> .	
	FORGET-ME-NOT . See <i>Myosotis</i> .	
	FOUR O'CLOCK . See <i>Mirabilis</i> .	
	FOXGLOVE . See <i>Digitalis</i> .	
2755	FRANCOA ramosa (Bridal Wreath). The long sprays of pure white flowers are largely used for table decoration. An excellent decorative greenhouse plant. 2 1/2 ft.25	

No.		Pkt.
2760	FREESIA, New Hybrids Mixed. Beautiful variety, with new colors and delicate shades, blooming in six to eight months..	\$0.25
2765	FUCHSIA, Double and Single Mixed. The raising of Fuchsias from seed is interesting, there always being the possibility of securing something new and distinct; the seed offered is saved from a choice collection..	.50
	GAILLARDIA (Blanketflower). Beautifully showy annuals, giving a profusion of brilliant flowers during the Summer and Autumn. Fine for cutting. 2 ft.	
2770	Single, Finest Mixed. All colors...	Oz. 75c. .10
2775	Double, Finest Mixed	¼ oz. 50c. .10
2780	amblyodon. Single, deep red....	¼ oz. 50c. .15
	GAILLARDIA grandiflora (Blanketflower). One of the most brilliant of all hardy perennials, and constant bloomer from June till frost; excellent for cutting. 2 ft.	
2785	sanguinea. Large, deep crimson with golden margin.....	¼ oz. 60c. .15
2790	maxima. Large, pure yellow....	¼ oz. 50c. .15
2793	Portola hybrida (New). Bronzy red shades, golden tipped.....	⅓ oz. 50c. .25
2796	Tangerine. Orange red.....	.25
2797	The Dazzler. Red, tipped gold....	⅓ oz. 35c. .15
2800	Finest Hybrids	¼ oz. 50c. .15
2805	GAURA lindheimeri. Half hardy annual of graceful habit with numerous sprays of rosy white flowers throughout the Summer. Fine for vases. 2 ft.....	¼ oz. 50c. .15
2810	GENISTA canariensis (Broom). Handsome, half hardy perennials for room decoration, with bright yellow flowers. 2 ft.....	.25
2815	andreaana. Crimson and yellow, handsome...	.25
2820	GENTIANA acaulis (Alpine Blue Gentian). Dwarf early, Spring-flowering Alpine perennial, with intense blue, bell-shaped flowers. 6 in.....	¼ oz. 85c. .15
2825	lutea (Giant Gentian). Bright yellow flowers in whorls on stems. 4 ft. high.....	.15
	GERANIUM. Popular plants, easily raised from seed. Half hardy perennial.	
2830	Apple-scented. Fragrant foliage.....	.25
2835	Show Pelargoniums (Lady Washington). Newest large-flowered Show varieties.....	.50
2840	zonale, Finest Mixed. Specially saved.....	.15
2845	Double, Finest Mixed. Finest sorts.....	.50
2850	GERARDIA, New Hybrids. Spikes of handsome, Foxglovelike flowers; very free flowering perennials, blooming first season from seed and hardy in sheltered situations. July to September. 2 ft.....	½ oz. 25c. .10
2855	GERBERA jamesoni (Transvaal Daisy). Beautiful Daisy of a brilliant orange vermilion color, on long stems, blooming almost the whole year if given greenhouse protection during Winter.....	.50
2860	jamesoni Hybrids. New hybrids of the preceding which are more hardy and easily grown. The colors are rich and delicate, with a wonderful range from pure white through orange, salmon, rose, cerise, to ruby red and violet.....	.50

No.		Pkt.
2865	GESNERIA, Mixed Hybrids. Greenhouse bulbous plants with beautiful marked velvety foliage and handsome spikes of brilliant colored flowers.....	\$0.50
	GEUM. Showy, hardy perennial of easy culture, and well adapted for the flower garden; fine for cutting. July to Oct. 2 ft.	
2875	coccienum. Bright scarlet.....	¼ oz. 30c. .10
2876	Mrs. Bradshaw. Double scarlet.....	.25
2877	Lady Stratheden. Beautiful orange.....	.25
2880	GILIA, Finest Mixed. Showy, hardy annual, blooming from early in the season until frost. 1 ft.....	¼ oz. 30c. .10
2885	GLAUCUM flavum tricolor (Horned-poppy). Free flowering, hardy annuals, with handsome silvery foliage and orange scarlet and black flowers in July. 2 ft.....	¼ oz. 50c. .15
	GLOBE-AMARANTH (Gomphrena). Showy annual everlasting; the flowers resemble clover heads, and when dried are used for Winter decoration; fine for bedding. 1½ ft.	
2890	Purple	¼ oz. 25c. .10
2895	Orange	¼ oz. 25c. .10
2900	White	¼ oz. 25c. .10
2905	Mixed. All colors.....	¼ oz. 25c. .10
	GLOXINIA. The seed offered has been selected from the finest erect flowering varieties and will give blooms of finest quality. For a succession of flowers from seed, sowings should be made at intervals from January to May. A moist heat of from 65 to 70 degrees is best to start them in.	
2910	Grey's Invincible Prize. This has the reputation of being the finest strain grown, very free flowering, with large, open flower in the greatest variety of colors.....	1.00
2915	Giant Mixed. A prize strain, with large flowers of richest colors.....	.50



Gaillardia grandiflora (Blanketflower)

No.		Pkt.
	GODETIA (Satin Flower). Handsome, hardy annuals, blooming profusely from July to Oct. Large, wide open flowers of shining satiny texture, and of the most delicate and brilliant colors. 1½ ft.	
2920	Duchess of Albany. Satiny white ¼ oz.	50c. \$0.10
2925	Double Rose. Large, bright rose. ¼ oz.	75c. .15
2930	gloriosa. Brilliant, blood red. ¼ oz.	60c. .10
2935	Lady Satin Rose. Rich rose pink. ¼ oz.	75c. .15
2937	Lavender. True color. ¼ oz.	75c. .15
2940	Mixed. Beautiful colors. ¼ oz.	35c. .10

GOURDS, Ornamental. Quick growing vines, desirable for covering arbors, walls, etc., and producing useful and ornamental fruit in great variety of shapes and colors. Tender annual. 15 to 20 ft.

2945	Collection of 12 sorts.	1.00
2950	Angora. White spotted fruit. Oz.	40c. .10
2955	Apple Shape. Striped fruit. Oz.	40c. .10
2960	Bottle Shape. White and green. Oz.	40c. .10
2965	Dipper Shape or Calabash. Oz.	40c. .10
2970	Dishcloth or Sponge. Oz.	40c. .10
2975	Egg Shape. Useful as nest eggs. Oz.	40c. .10
2980	Gooseberry. Very small. Oz.	60c. .10
2985	Hercules Club. 4 ft. long. Oz.	40c. .10
2990	Orange Shape. Mock orange. Oz.	40c. .10
2995	Pear Shape. Striped. Oz.	40c. .10
3000	Serpent Shape. 4 to 5 ft. long. Oz.	40c. .10
3005	Sugar Trough. Oz.	40c. .10
3010	Mixed Sorts. In great variety. Oz.	30c. .10

GRASS, Ornamental. See page 62.

3015	GREVILLEA robusta (Silk-oak). Beautiful evergreen, with fern-like foliage, magnificent for decorative purposes, and well adapted for house culture. Tender perennial. ¼ oz.	50c., oz. \$1.75 .15
------	--	----------------------



Helichrysum

No.		Pkt.
	GYPSOPHILA (Babysbreath). Extremely light and graceful, hardy plants of easy growth, flowering from June to Sept. Useful for cutting to mix with other flowers.	
3020	elegans alba grandiflora. Large, white, annual. ¼ oz.	15c., oz. 50c. \$0.10
3025	elegans rosea. Rose-pink, annual. Oz.	50c. .10
3030	paniculata. Pure white hardy. ¼ oz.	50c. .10
3035	fl. pl. Double, white, hardy. This variety produces only about 60 per cent of double flowering plants.	.25
	HELENIUM. A most valuable hardy perennial, very striking and fine for cutting, as it gives an enormous crop of flowers in the late Summer and Autumn. 5 ft.	
3045	autumnale superbum. Golden; fine.	.25
3050	bigelowi. Golden yellow, with black center	.15
3055	HELIANTHEMUM mutabile. Dwarf hardy perennial, with brilliant flowers of various colors; very profuse in bloom and suited for dry soil and rockeries. June to Sept. 6 in. ¼ oz.	60c. .15
	HELIANTHUS (Sunflower). Well-known hardy annuals, the small flowering sorts being very useful for cutting, while the larger sorts are very ornamental and useful, blooming all Summer.	
3060	Double Californian. Deep yellow. 5 ft. Oz.	50c. .10
3065	Double Chrysanthemum flowered. Orange yellow, fine for cutting. 5 ft. Oz.	60c. .10
3070	Dwarf. Orange. 3 ft. Oz.	50c. .10
3075	globosus fistulosus. Large, globe shaped, rich orange color. 7 ft. Oz.	30c. .10
3080	Single cucumerifolius (Miniature Sunflower). Small, bright yellow, with black center. 4 ft. Oz.	75c. .10
3090	cucumerifolius Stella. Golden yellow. The largest miniature sort. 4 ft. Oz.	\$1.00 .10
3095	giganteus uniflorus. One immense flower a foot or more across. Oz.	35c. .10
4000	Giant Russian. Large. 6 ft. Oz.	20c. .10
4002	Golden Fleece. Small Cactus flowers, golden yellow; dark center.	.15
4005	Sutton's Red. Deep crimson, shading lighter toward the points. ¼ oz.	50c. .15
4010	Perennial Hybrids. The flowers vary in shades, size and form. ¼ oz.	\$1.00 .15
	HELICHRYSUM, Double Flowered. Pretty annual everlasting, blooming all Summer; fine in mixed borders and useful as dried flowers for Winter for which purpose they should be gathered before being fully open. 2 ft.	
4015	Mixed. ¼ oz.	50c. .10
4016	Canary Yellow. ¼ oz.	60c. .15
4017	Deep Crimson. ¼ oz.	60c. .15
4018	Salmon. ¼ oz.	60c. .15
4019	Golden Ball. ¼ oz.	60c. .15
4020	Rose Queen. ¼ oz.	60c. .15
4021	Silver Pink. ¼ oz.	60c. .15
4022	Violet. ¼ oz.	60c. .15
4024	White. ¼ oz.	60c. .15
	HELIOTROPE. A universal favorite on account of its delicious fragrance; excellent for cutting. Half hardy perennial.	
4025	Grey's Giant Dwarf. Splendid strain of low, compact growth. ⅛ oz.	85c. .25
4030	Giant Hybrids. Mammoth. ⅛ oz.	85c. .25
4035	Mixed Dark Blue Shades. ⅛ oz.	50c. .15
4040	HELLEBORUS, Mixed Hybrids (Christmas Rose). Largely cultivated for their flowers in Midwinter, at which time they will bloom with only the protection of a coldframe. Hardy perennial. 1 ft.	.25

No.		Pkt
	HESPERIS matronalis (Sweet Rocket). Fragrant Spring flowering hardy perennial, growing freely in ordinary soils.	
4045	Dwarf Pure White. Early. 1 ft..¼ oz. 50c.	\$0.15
4050	Pure White. 3 ft.....Oz. \$1.50	.10
4055	Purple. 3 ft.....Oz. 1.50	.10
4060	Mixed. Purple and white.....Oz. 1.00	.10
4064	HEUCHERA choice Hybrids. Dwarf hardy perennials. Spikes of numerous small bell-shaped flowers, well above the foliage. 1 ft.	.25
4065	Sanguinea Splendens. Brilliant crimson.	.25
	HIBISCUS. A showy class of plants suitable for mixed beds or borders, with large and beautifully colored flowers. Free flowering. Hardy perennials, unless noted.	
4070	africanus. Buff, with maroon center. Hardy annual. July to October. 2 ft... ¼ oz. 35c.	.10
4075	Crimson Eye. Large, pure white, crimson center, July to Sept. 4 ft.....¼ oz. 50c.	.15
4080	Moscheutos Rose. Large, light rose. July to Oct. 4 ft.....¼ oz. 50c., oz. \$1.50	.15
4085	Moscheutos White. Large, pure white. July to Oct. 4 ft...¼ oz. 50c., oz. \$1.50	.15
4087	Moscheutos Hybrid. Large flowering, mixed.....¼ oz. 50c., oz. \$1.50	.15
	HOLLYHOCK. One of the oldest garden favorites and finest of our Autumn flowers. Seed sown in February and potted on will bloom the same season, and July sown seed the next season. They require a well drained, deep, rich soil. Hardy biennial.	
4095	Collection of Double Varieties, 6 colors..	1.00
5000	Double Superb Mixed. An improved strain.....¼ oz. 75c., oz. \$2.75	.20
5005	Double Crimson..... ¼ oz. 75c., oz. \$2.75	.20
5006	Exquisite. A large, double fringed Hollyhock in a variety of colors with margined and blotched petals.....	.25
5007	Imperator. Flowers 5 or 6 in. across, fringed with rosette centers; many colors.....	.35
5008	Newport Pink..... ¼ oz. 75c., oz. \$2.75	.20
5012	Purple..... ¼ oz. 75c., oz. \$2.75	.20
5015	Rose Pink..... ¼ oz. 75c., oz. \$2.75	.20
5020	Royal Scarlet..... ¼ oz. 75c., oz. \$2.75	.20
5025	Snow White..... ¼ oz. 75c., oz. \$2.75	.20
5030	Yellow..... ¼ oz. 75c., oz. \$2.75	.20
5035	Single Mixed..... ¼ oz. 75c.	.15
5037	Collection, Single Varieties, 5 colors.....	1.00
5040	Allegheny. Large, fringed double and semi-double flowers.....¼ oz. 60c., oz. \$2.00	.10
	EVERBLOOMING HYBRIDS (Annual). Beautiful flowers in all colors and shades, blooming readily the first season.	
5045	Double Mixed..... ¼ oz. 75c.	.15
5050	Single Mixed..... ¼ oz. 60c.	.15
5055	HONESTY, Mixed (Lunaria biennis). Early and free flowering hardy biennial. The seed pods, which are flat and broad, look like transparent silver and are much prized for Winter decoration. 2 ft...¼ oz. 50c.	.10
	HUMULUS (Hop). The annual sorts are rapid growing climbers, with handsome foliage, which does not suffer from heat or the attacks of insects. The perennial sort produces the noted hop of commerce, and is a fine climber. 15 to 20 ft.	
5060	japonicus. Green foliage.....¼ oz. 30c.	.10
5065	variegatus. Variegated foliage..¼ oz. 30c.	.10
5070	lupulus. Hardy perennial.....¼ oz. 40c.	.10

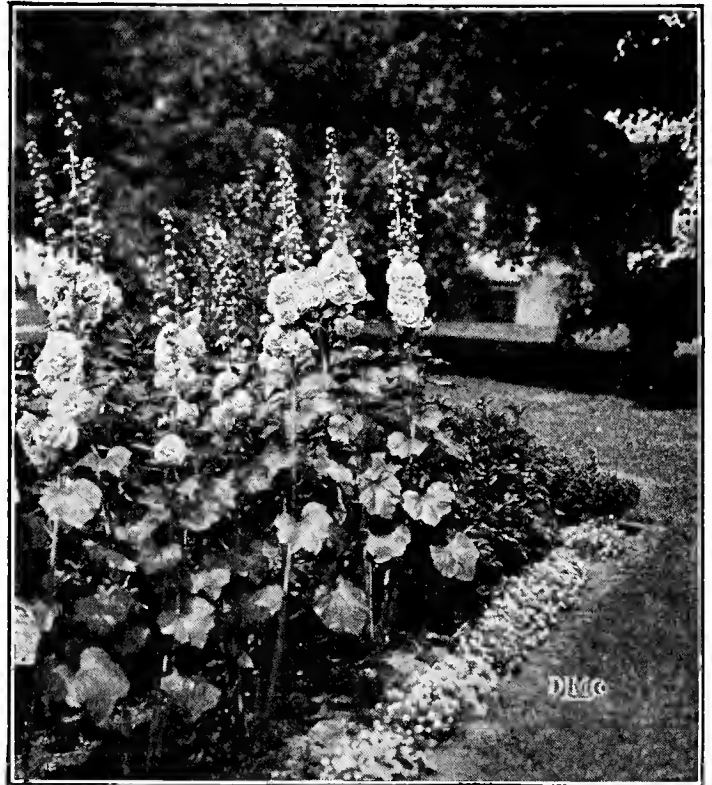

Hollyhocks

No.		Pkt.
5075	HUNNEMANNIA fumaraeifolia (Giant yellow Tulip Poppy, or Bush Eschscholtzia). Perennial, with large, yellow, Poppy-like flowers throughout the season. Blooms in three months from seed. 2 ft..¼ oz. 50c.	\$0.10
	IBERIS (Hardy Candytuft). Free flowering, compact perennials, making a beautiful display early in the season; suitable for rockeries and borders; fine for cutting. 1 ft.	
5080	gibraltarica. Very large flowers of a delicate lilac color.....¼ oz. \$1.50	.15
5083	Queen of Italy. Rosy lilac.....¼ oz. 50c.	.15
5085	sempervirens. The evergreen Candytuft with glossy, deep green foliage and white flowers.....¼ oz. \$1.75	.15
	Annual Varieties. See Candytuft.	
5090	ICE PLANT. Half-hardy annual with leaves and stems thickly covered with sparkling ice-like globules. Fine for vases and piazza boxes, also for garnishing. Flowers white, 6 in.....¼ oz. 25c.	.10
	IMPATIENS (Sultan's or Zanzibar Balsam). A very fine, tender perennial for pot culture in the house or greenhouse, and very useful for Summer bedding, as they are in bloom continually.	
5095	holsti. Large, brilliant vermilion. 1½ ft..	.50
5100	holsti Hybrids. Choice colors of these large flowered new sorts. 1½ ft.....	.35
5105	sultani. Large, rich bright rose. 1 ft....	.25
5110	INCARVILLEA delavayi. Fine half-hardy tuberous-rooted perennial, with large bright rose-colored, bell-shaped flowers in clusters. The tubers can be taken up and stored through the Winter. 2½ ft.....	.25
5115	INULA glandulosa grandiflora. Very bold and handsome hardy perennial, with large orange-yellow flowers. 2 ft.....	.25



♣ Lobelia

- | No. | | Pkt. |
|------|--|--------|
| | IPOMOEA. Splendid rapid growing climbers, with large, bright colored flowers, they are exceedingly pretty when grown among other climbers. Hardy annual. 15 ft. | |
| 5120 | purpurea, Finest Mixed (Morning-glory, <i>Convolvulus major</i>) . . . Oz. 25c. ¼ lb. 75c. | \$0.10 |
| 5125 | purpurea, Double Mixed Oz. 50c. | .10 |
| 5130 | coccinea (Star Ipomoea). Scarlet, star-shaped flowers in profusion. Oz. 60c. | .10 |
| 5135 | Heavenly Blue. Immense beautiful flowers of bright sky blue; seed should not be sown outside till ground is warm. . . . ¼ oz. 75c. | .15 |
| 5140 | imperialis japonica (Japanese Giant). Most beautiful strain, with immense flowers of finest colors and markings. Oz. 60c. | .10 |
| 5145 | noctiflora hybrida (Moonflower). Large, fragrant, white flowers. Oz. \$1.00 | .10 |
| 5148 | Rose Marie. New, double deep rose. | .25 |
| 5150 | setosa. Enormous leaves and large, rose-colored flowers in clusters. Oz. 75c. | .10 |
| | quamoclit (Cypress Vine). Finely cut, fern-like foliage and masses of brilliant, star-shaped flowers. | |
| 5155 | Bright Scarlet. Oz. \$1.00 | .10 |
| 5160 | Pure White. Oz. 1.00 | .10 |
| 5165 | Mixed. Scarlet, white and pink. . . . Oz. 1.00 | .10 |
| 5170 | hybrida (Cardinal Climber). Large, brilliant cardinal red flowers in clusters, all Summer. | .25 |
| 5175 | IRIS, Mixed Varieties. All sorts and colors of this beautiful Spring and Summer blooming hardy perennial. ¼ oz. 75c. | .10 |
| | JACOBS-LADDER. See <i>Polemonium</i> . | |
| | KENILWORTH IVY. See <i>Linaria cymbalaria</i> . | |
| 5180 | KOCHIA trichophylla (Mock Cypress, or Belvedere). A pretty half-hardy annual, forming compact bushes about 2½ ft. high, with small, feathery, light green foliage which changes to a crimson hue in September. ¼ oz. 25c. | .10 |

- | | | |
|------|---|--------|
| No. | LANTANA. Most elegant and showy bedding Pkt. plants of as easy culture as Verbena or Geranium; flowers freely produced in beautiful clusters, and constantly changing in hue. | |
| 5185 | New Dwarf Bedding Hybrids. 1 ft. | \$0.25 |
| 5190 | Tall Hybrids. 2 ft. ¼ oz. 50c. | .15 |
| | LARKSPUR. See <i>Delphinium</i> . | |
| | LATHYRUS latifolius (Perennial Pea). Handsome, free-flowering, hardy perennial climber of great beauty, with clusters of elegant, Sweet Pea-like flowers in great profusion; useful as a cut flower. 6 ft. | |
| 5195 | albus. Pure white, very desirable. ¼ oz. 75c. | .15 |
| 5200 | Pink Beauty. Bright rosy pink. ¼ oz. 75c. | .15 |
| 5205 | splendens. Rich crimson. ¼ oz. 75c. | .15 |
| 5210 | Mixed. All colors. ¼ oz. 40c., oz. \$1.25 | .10 |
| | LAVATERA trimestris (Bar Harbor Marsh Mallow). Large flowered variety, hardy annual, allied to the Mallows, covered during the entire Summer with its pretty and showy blossoms. 2½ ft. | |
| 5215 | splendens. Rose. ¼ oz. 50c. | .15 |
| 5220 | splendens. White. ¼ oz. 50c. | .15 |
| 5225 | LAVENDULA vera (Sweet Lavender). Chiefly cultivated for the delicious and lasting fragrance of its flowers. Hardy perennial. July to September. 2 ft. Oz. \$1.00 | .15 |
| 5230 | LEPTOSYNE maritima. Free flowering hardy annual, large single yellow Coreopsis-like flowers on long stems; fine for cut flowers. Aug. to Oct. 2 ft. ¼ oz. \$1.00 | .15 |
| 5235 | LIATRIS spicata (Blazing-star). Desirable hardy perennial. The brilliant rosy purple flowers are on long spikes and freely produced. July to Sept. 2 ft. | .15 |
| 5240 | LILIUM regale (Royal Lily). | .50 |
| | LINARIA (Toadflax). Annual. | |
| 5242 | aparinoides Mixed Hybrids. | .15 |
| 5243 | maroccana Excelsior Mixed. | .15 |
| 5244 | bipartita Mixed (Snapdragon). | .15 |
| 5245 | cymbalaria (Kenilworth Ivy). Beautiful, trailing plants for baskets or rock work. | .15 |
| | LINUM. A valuable class of plants flowering for months and worthy of extended cultivation in masses or clumps in mixed borders. 1½ ft. | |
| 5250 | grandiflorum rubrum. Brilliant dark scarlet, profuse flowering annual. . . . Oz. 75c. | .10 |
| 5254 | perenne, Blue. June-Aug. Fine for borders. | .25 |
| 5255 | Mixed Perennial Sorts. Fine. ¼ oz. 50c. | .10 |
| | LOBELIA. Most useful plants, free flowering and of easy culture. For bedding, edging, vases, etc. Treated as annuals, except the Cardinal varieties. | |
| 5260 | cardinalis. Brilliant scarlet; hardy. 3 ft. . . . | .25 |
| 5265 | grandiflora. Flowers double the size of the old sorts; hardy. 3 ft. | .25 |
| 5267 | Blue Wings. A splendid dwarf blue variety; large flowers. | .25 |
| 5270 | Crystal Palace compacta. Extra select dark blue; fine for edgings. ⅛ oz. \$1.00 | .15 |
| 5275 | gracilis. Spreading habit, with bright blue flowers; suitable for vases, etc. ¼ oz. 75c. | .15 |
| 5280 | hybrida, Sapphire. Deep sapphire blue, with white eye. Fine for hanging baskets. | .25 |
| 5285 | speciosa (Crystal Palace). Spreading habit, with dark blue flowers. ¼ oz. 85c. | .15 |
| 5290 | White Lady. Compact, large flowered, pure white. ¼ oz. 60c. | .10 |
| 5295 | ramosa (Erect growing). Rich blue, large flowered, distinct and striking. 9 in. ⅛ oz. 50c. | .25 |
| 5300 | alba. Large white. ⅛ oz. 50c. | .25 |
| 5305 | Heavenly Blue. Large, clear blue. ⅛ oz. 50c. | .25 |
| 5310 | rosea. Large, deep rose. ⅛ oz. 50c. | .25 |

No.		Pkt.
5315	LOPHOSPERMUM scandens. Beautiful half-hardy climber, well suited for baskets and vases. Bright pink. 1/8 oz. 60c. . . . \$0.15	
	LUPINUS (Lupins). Old-fashioned and well-known annuals, very free growing, with long spikes of bright colored, pea-shaped flowers, and useful in a cut state. 2 1/2 to 3 ft.	
5320	cruickshanki. Dark blue; fine. Oz. 50c.10	
5325	hartwegi albus. White. Oz. \$1.0010	
5330	Cambridge Blue. Sky blue. Oz. \$1.0010	
5335	Oxford Blue. Rich dark blue. Oz. \$1.0010	
5340	roseus. Fine rose pink. Oz. \$1.0010	
5345	mutabilis. White, sweet scented. Oz. 50c.10	
5350	roseus hybridus. Bright rose pink. Oz. \$1.5015	
5355	Mixed Annual Sorts. All colors. Oz. 50c.10	
	LUPINUS (Lupines). Perennial Varieties. Handsome hardy perennials with immense spikes of pea shaped flowers. 3 ft.	
5360	polyphyllus, Blue. Oz. 75c.10	
5362	Elliott's Sweet Scented. Mixed colors.20	
5363	Lavender Queen.15	
5365	moerheimi. Rose and white. Oz. \$2.5025	
5370	roseus. Pink shades. Oz. \$1.5015	
5375	White. Oz. 75c.10	
5380	Mixed. Oz. 75c.10	
5385	Excelsior Mixed. New shades. Oz. \$1.2515	
	LYCHNIS. Hardy perennials with large terminal trusses of very showy flowers; excellent for massing. 1 1/2 to 2 ft.	
5390	chalconica. Brilliant scarlet. 1/4 oz. 50c.10	
5395	alba. White. 1/4 oz. 50c.10	
5400	viscaria splendens. Deep red. 1/4 oz. 60c.10	
5405	haageana hybrida. 1/4 oz. 85c.15	
5410	LYTHRUM roseum superbum. Vigorous perennial with spikes of bright rose colored flowers through Summer and Autumn. 3 ft.15	



Marigold, Grey's Selected Orange Prince

No.		Pkt.
	MALOPE. Free blooming, hardy annuals, with large, handsome, mallow-like flowers; suitable for mixed borders and fine for cutting. July to Oct. 3 ft.	
5415	grandiflora alba. White. Oz. 75c. \$0.15	
5420	grandiflora rosea. Rose-pink. Oz. 75c.15	
	MALVA or MALLOW. Free flowering, hardy perennials, highly decorative for borders, and excellent for cutting; sown early, will bloom first season.	
5425	alcea. Pink; blooms all Summer. 1/4 oz. 85c.15	
5430	moschata (Muskmallow). Clusters of fragrant rose-colored flowers. 1/4 oz. 50c.15	
5435	alba. White, fragrant flowers. 2 1/2 ft. 1/4 oz. 50c.15	
5440	crispa (Curled Mallow). Ornamental foliage, with curled and frilled edges. Annual. 4 ft. 1/4 oz. 50c.15	
	MARIGOLD, Double African. Handsome hardy annuals, with rich and showy flowers throughout the season; making a gorgeous display in the Autumn. 3 ft.	
5445	Grey's Selected Orange Prince25	
5450	Grey's Selected Lemon Queen25	
	Above two sorts specially grown for us by a Scotch specialist and are without an equal.	
5455	Collection of 6 varieties, separate50	
5460	Lemon. Extra. 1/4 oz. 40c.10	
5465	Orange. Extra. 1/4 oz. 40c.10	
5470	Pride of the Garden. Deep yellow quilled. 1 1/2 ft. 1/4 oz. 40c.10	
5475	El Dorado Mixture. Finest large-flowered sorts. 1/4 oz. 50c.15	
5480	Dwarf Mixed. 1 1/2 ft. 1/4 oz. 50c.10	
	MARIGOLD, French. These are the small velvety flowered sorts.	
5485	Collection of 6 varieties, separate50	
5490	Dwarf Gold Striped. Double, 1 ft. 1/4 oz. 50c.15	
5495	pulchra. Very dwarf, double striped, for edgings. 6 in. 1/4 oz. 50c.15	
5500	Double Mixed. 1 ft. 1/4 oz. 40c.10	
5505	Scotch Prize. Special Scotch strain, from double striped prize flowers only. 2 1/2 ft. 1/4 oz. \$2.5025	
5510	Tall Double Mixed. 2 1/2 ft. 1/4 oz. 50c.10	
5515	Legion of Honor (Little Brownie). Single golden yellow, with a large spot of crimson velvet. 1 ft. 1/4 oz. 50c.15	
5520	signata pumila (Tagetes). Single orange yellow. 1 ft. 1/4 oz. 50c.10	
5522	Star of India. Single crimson striped yellow. 1/4 oz. 60c.15	
5525	MATTHIOLA bicornis (Night-scented Stock). Recommended for the delightful fragrance given forth toward evening; hardy annual, with purplish red flowers. 1 ft. 1/4 oz. 50c.10	
	MATRICARIA (Feverfew). Free flowering annuals, useful for groups, borders and pot culture; also fine for cut flowers. 1 1/2 ft.	
5530	Double White (Grandiflora). 1/8 oz. 75c.20	
5535	Double Yellow (Golden Ball). Quilled petals. 1/8 oz. 75c.20	
5540	MAURANDYA, Finest Mixed. Elegant twining plants, with purple, rose and white flowers. Splendid for hanging baskets, window boxes, etc. 1/8 oz. 75c.10	
5542	MECONOPSIS baileyi. Perennial sky blue.50	
	MESEMBRYANTHEMUM. Dwarf growing annuals of great beauty; excellent for rockeries, edgings, vases, etc. 6 in.	
5545	tricolor Mixed. Bright rose, white and purple. 1/4 oz. 50c.15	
5550	cordifolium variegatum. Handsome, variegated foliage and bright rose colored flowers.25	
	crystallinum. See Ice Plant.	

No.		Pkt.
	MIGNONETTE (Reseda). The most popular and favorite annual for garden and house culture, producing quantities of deliciously fragrant spikes of flowers. If the plants are thinned out to 6 in. apart, and the tops pinched off when about 2 in. high, stronger plants with larger spikes of flowers, will be obtained.	
5555	Improved Eclipse. The immense, fragrant spikes of flowers 10 to 15 in. long, are produced in the greatest profusion, and is superior to all others for Winter blooming, exhibition, or cutting. The seed is all grown under glass from a reselected strain especially for us, and we recommend this as the largest and best..... 1/4 oz. \$2.00	\$0.50
5560	Defiance. Very fragrant, large spikes, with individual florets of immense size..... 1/4 oz. 40c., oz. \$1.25	.10
5565	Giant Pyramidal. Large, fragrant spikes of reddish flowers..... 1/4 oz. 25c., oz. 75c.	.10
5570	Machet Improved. Dense spikes of very fragrant, dark red flowers; fine for pot culture..... 1/4 oz. 50c., oz. \$1.50	.15
5575	Machet, Golden. Long, massive spikes with fragrant, golden-yellow flowers..... 1/4 oz. 25c., oz. 75c.	.10
5580	Machet, White Pearl. Long spikes of fragrant white flowers..... 1/4 oz. 50c.	.10
5585	Miles Spiral. Long, fragrant spikes..... 1/4 oz. 20c., oz. 50c.	.10
5590	odorata. The old-fashioned common sweet-scented sort..... Oz. 35c., 1/4 lb. \$1.00	.10
5595	MIMOSA pudica (Sensitiveplant). A tender annual of light and elegant growth, the leaflets of which fold up when touched; the pale, purplish flowers are produced at the axils of the leaves. 2 ft..... 1/4 oz. 50c.	.15



Machet Mignonette

No.		Pkt.
	MIMULUS. Showy, half-hardy annuals, with handsome flowers; excellent for pots or garden.	
5600	cardinalis grandiflorus. Large, bright scarlet. 2 ft.....	\$0.15
5605	tigrinus grandiflorus. Large - flowered, tigered and spotted varieties. 1 1/2 ft.....	.15
5610	Musk (Moschatus). Well-known, popular plant, with fragrant, yellow flowers and foliage..... 1/8 oz. 85c.	.25
5615	MINA lobata. A rapid growing annual climber bearing profusely racemes of orange-red flowers; prefers a warm situation. 1/4 oz. 85c.	.15
	MIRABILIS (Marvel of Peru, or Four-o'clock). Well known annuals, with most brilliant flowers of various colors, suitable for beds or borders. 2 ft.	
5620	Mixed. Brilliant colors..... Oz. 35c.	.10
5625	Variegated Foliage, Mixed. All colors, with green and white leaves..... Oz. 35c.	.10
	MOMORDICA. Ornamental, climbing annual, with handsome fruit which, when ripe bursts open, exposing its bright red seeds and carmine interior.	
5630	balsamina (Balsam-apple). Apple-shaped fruit. 10 ft..... Oz. \$1.00	.10
5635	charantia (Balsam-pear). Pear-shaped fruit. 10 ft..... Oz. \$1.00	.10
	MOONFLOWER. See <i>Ipomoea</i> .	
	MORNING GLORY. See <i>Ipomoea purpurea</i> .	
	MOURNING BRIDE. See <i>Scabiosa</i> .	
	MOUNTAIN FRINGE. See <i>Adlumia</i> .	
5640	MUSA ensete (Abyssinian Banana). A splendid, large-leaved, palm-like plant, suitable for open air in Summer, and producing a striking effect; seedlings attain a very large size the first season; tender perennial. 100 seeds \$2.50	.25
	MUSK PLANT. See <i>Mimulus</i> .	
	MYOSOTIS (Forget-me-not). These beautiful half-hardy perennials bloom the first season and succeed best in moist, shady situations. If sown in frames in July or August, fine plants may be had for Spring blooming. Fine for edging or in beds with Pansies, Daisies, etc.	
5645	alpestris grandiflora. Large, bright blue clusters..... 1/4 oz. \$1.00	.15
5650	Indigo or Royal Blue. Rich. 1/4 oz. \$2.00	.25
5653	Indigo compacta. Very dwarf. 1/4 oz. \$2.50	.25
5655	Victoria. Rich, bright blue, of dwarf, globular habit..... 1/4 oz. \$2.50	.20
5658	Victoria alba. White..... 1/4 oz. \$2.50	.20
5660	Victoria rosea. Fine pink..... 1/4 oz. \$2.50	.20
5665	dissitiflora. Rich blue, the earliest to flower and quite distinct..... 1/4 oz. \$2.00	.25
5670	Perfection. Bright blue flowers on long stalks last a long time, and are most suitable for table decoration at Christmas. Sow in June for Winter blooming. The finest of all..... 1/4 oz. \$2.00	.25
5675	palustris semperflorens (True Forget-me-not). Large, azure blue flowers. 1/4 oz. \$2.50	.25
5680	Ruth Fischer. Azure blue. The largest flowered variety.....	.25
5685	stricta grandiflora. Upright, pillar-like habit; bright blue; very striking. 1/4 oz. \$1.50	.15
5690	Special Mixture. All colors.... 1/4 oz. \$1.00	.15

No.		Pkt.
	NASTURTIUM, Dwarf, or Tom Thumb varieties. Splendid for marginal lines to borders and indispensable Summer bedding plants. They succeed best and flower better in poor soil and remain longer in bloom than perhaps any other annual. 1 ft.	
	Oz. 25c., ¼ lb. 75c., lb. \$2.50, unless priced.	
5695	Collection of 12 colors. Our selection.....	\$1.00
5700	Columbia Mixture. Our own mixture which we make up from separate and distinct sorts; is without an equal.....	.10
5705	Aurora. Primrose, striped with carmine....	.10
5710	Bronze. Bronzy orange.....	.10
5715	Beauty. Light scarlet.....	.10
5720	Chameleon. Straw color, flaked and veined red.....	.10
5725	coerulea rosea. Rose, blue tinge.....	.10
5730	Crystal Palace Gem. Buff, spotted.....	.10
5735	Dark Crimson. Fine, deep color.....	.10
5740	Empress of India. Deep, brilliant crimson, dark foliage.....	.10
5745	Golden King. Rich, golden yellow.....	.10
5750	King Theodore. Maroon, dark foliage....	.10
5755	King of Tom Thumb. Rich scarlet, dark foliage.....	.10
5760	Lady Bird. Yellow, barred with ruby.....	.10
5765	Pearl. Pearly white.....	.10
5770	Prince Henry. Yellow, scarlet spots.....	.10
5775	Rose. Soft earmine rose.....	.10
5780	Ruby King. Rich ruby red, dark foliage...	.10
5785	Scarlet. Very brilliant.....	.10
5790	Spotted King. Yellow, spotted maroon, dark foliage.....	.10
5795	Vesuvius. Brilliant salmon-pink, dark foliage.....	.10
5800	Ivy-leaved, Mixed. Ivy-like foliage and attractive fringed flowers.....	.10
	Oz. 25c., ¼ lb. 75c.	.10
5805	Variegated-leaved, Mixed. Beautifully variegated foliage.....	Oz. 25c., ¼ lb. 75c. .10
5810	NASTURTIUM lilliput, Finest Mixed. A distinct and fine flowering class, with its small, compact bushes and immense numbers of small blooms displayed well above the foliage.....	Oz. 35c. .10
	NASTURTIUM, Tall or Running Varieties.	
	These are the large free flowering climbers for verandas, trellises and covering unsightly places. Seed pods picked when green and tender are used for pickling.	
	Oz. 25c., ¼ lb. 75c., lb. \$2.25, unless priced.	
5815	Collection of 12 colors. Our selection....	1.00
5820	Columbia Mixture. Our own mixture, which we make up from separate and distinct sorts is without an equal.....	.10
5825	Bright Rose10
5830	Chameleon. Varying in color.....	.10
5835	coccineum. Bright scarlet.....	.10
5840	Dark Crimson10
5845	Dunnett's Orange. Orange red.....	.10
5850	Edward Otto. Brownish lilac.....	.10
5855	Fashion. Pure ecru, veined with old rose...	.10
5858	Gold Garnet. Orange yellow, spotted garnet.....	.10
5865	King Theodore. Very deep maroon.....	.10
5870	luteum. Fine yellow.....	.10
5875	Moonlight. Giant pale straw.....	.10
5880	Pearl. Almost white.....	.10
5885	regelianum. Violet ruby.....	.10
5892	Shillingi. Yellow spotted maroon.....	.10
5895	Sunlight. Giant, rich golden.....	.10
5900	Twilight. Light salmon, suffused with rosy salmon.....	.10

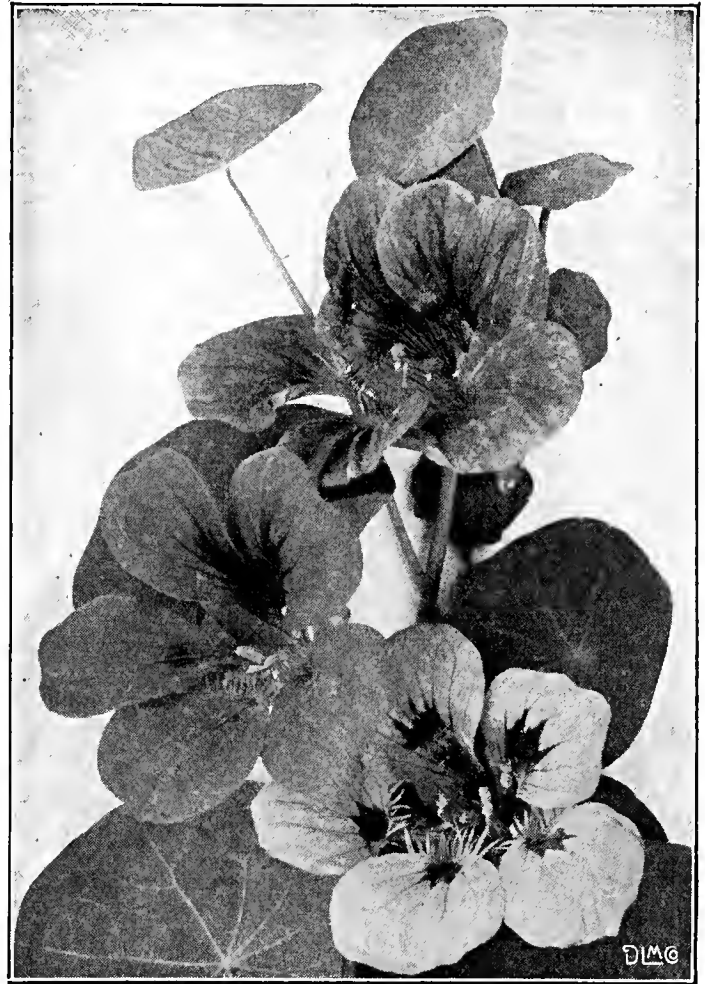

Nasturtiums

No.		Pkt.
	NASTURTIUMS, Tall—Continued	
5905	Vesuvius. Rich apricot, dark foliage.....	\$0.10
5910	Von Moltke. Dark rose.....	.10
5915	Ivy-leaved, Mixed. Ivy-like foliage and fringed flowers in variety.	.10
	Oz. 25c., ¼ lb. 75c.	.10
5920	Variegated-leaved, Mixed. An exceedingly fine acquisition.....	Oz. 25c., ¼ lb. 75c. .10
	NASTURTIUM, lobbianum Varieties. These differ from the tall Nasturtiums, in being more free flowering, richer and brighter in color, and with darker foliage, and are superior for house or conservatory, also vases, baskets, etc. Are a mass of color from early Summer until frost.	
5925	Asa Gray. Almost white.....	Oz. 25c. .10
5930	Black Prince. Velvety black.....	Oz. 35c. .10
5935	Brilliant. Dazzling scarlet.....	Oz. 25c. .10
5940	Cardinal. Dark cardinal red.....	Oz. 25c. .10
5945	Crown Prince. Deep blood red.....	Oz. 25c. .10
5947	Firefly. Yellow scarlet spotted.....	Oz. 25c. .10
5950	Golden Queen. Clear golden.....	Oz. 25c. .10
5955	Margaret. Straw, crimson spot.....	Oz. 25c. .10
5965	Napoleon III. Golden brown spot.....	Oz. 25c. .10
5970	Primrose. Cream brown spots.....	Oz. 25c. .10
5975	Regina. Beautiful salmon.....	Oz. 25c. .10
5978	Roi des Noirs. Black brown.....	Oz. 25c. .10
5980	Rudolf Virchow. Ruby rose.....	Oz. 25c. .10
5985	Spitfire. Bright scarlet; splendid....	Oz. 25c. .10
5990	Mixed. All colors.....	Oz. 20c., ¼ lb. 60c. .10
5995	Madam Gunther Hybrids. Dark foliage hybrids.....	Oz. 25c. .10

No.		Pkt.
6000	NEMESIA strumosa suttoni, Improved Mixed. A valuable long-blooming annual.	\$0.25
6001	Blue Gem, Improved nana compacta25
6002	Fire King, strumosa grandiflora suttoni25
6003	Orange Prince, strumosa grandifl. suttoni25
6003A	Rose, strumosa grandiflora suttoni25
6004	White Gem, Improved nana compacta ..	.25
	NEMOPHILA. Splendid, showy hardy annual for beds or edgings; beautiful decorative plants in pots for Spring flowering in house or conservatory. 1 ft.	
6005	insignis. Bright blue, white center.	¼ oz. 20c. .10
6010	Mixed. All shades.....	¼ oz. 20c. .10



Pansy, Grey's Prize Exhibition Strain

No.		Pkt.
	NICOTIANA. Very effective annuals; in bloom throughout the season, and produce their fragrant, tubular-shaped flowers in great profusion; excellent for cutting.	
6015	affinis. White; fragrant; 3 ft....	¼ oz. 35c. \$0.10
6020	Choice Hybrids. A great variety of bright colors; fragrant.....	¼ oz. 60c. .10
6022	Crimson Bedder. Dwarf, pyramidal rich deep crimson, 15 in.....	.25
6025	colossea. Giant foliage plant of a dark glossy green, with reddish ribs. 5 to 6 ft..	.25
6030	sanderae. Brilliant carmine red..	¼ oz. 50c. .10
6035	sylvestris. Pure white. 4 ft.....	¼ oz. 50c. .10
	NIEREMBERGIA. Graceful, half-hardy perennials of slender growth, blooming profusely the whole Summer; fine for vases, baskets, etc.	
6040	frutescens. White and blue.....	.15
6045	gracilis. White and purple.....	.15

No.		Pkt.
	NIGELLA (Love-in-a-mist). Interesting and free flowering, half-hardy annuals, with elegant cut foliage and curious flowers, of easy culture. 1½ ft.	
6050	Miss Jekyll. Beautiful long-stemmed variety, bright Cornflower blue..	¼ oz. 35c. \$0.10
6052	Miss Jekyll. White.....	¼ oz. 50c. .15
6055	Mixed. Shades of blue and white..	Oz. 35c. .10
6060	NYCTERINIA, Finest Mixed. Large heads of sweet-scented, star-shaped flowers, produced throughout the whole season; hardy annual.....	¼ oz. 50c. .10
	OENOTHERA (Evening-primrose). A magnificent class of hardy plants, with large showy blossoms, preferring a light, sandy soil, and warm, sunny situations; July to October. 2 to 3 ft.	
6065	fraseri. Large, deep yellow; fine.	¼ oz. \$1.50 .15
6070	lamarkiana. Extra large yellow.	¼ oz. 50c. .10
6073	odorata. Yellow, fragrant....	¼ oz. 40c. .10
6075	speciosa rosea. Fine rose color..	⅛ oz. 75c. .25
6085	Annual Varieties, Mixed	¼ oz. 25c. .10
6090	OXALIS tropaeoloides. Fast growing, hardy annual, with dark bronze foliage and deep yellow flowers, best suited to edgings, rockwork, vases, etc. 6 in....	¼ oz. 85c. .15
	PANSY. Too much importance cannot be attached to the culture of these beautiful plants. For early Spring blooming the seed should be sown in July or August and the plants protected during Winter. Early Spring sown seed will give fine blooms during Summer and Fall. A good, cool, rich soil is essential. Rotted cow manure is the best fertilizer for them, and one cannot use too much of it. No fertilizer of a heating nature should be used; give plenty of water through dry weather. You cannot grow good Pansies under trees.	
6095	Grey's Prize Exhibition Strain. This splendid mixture represents the highest perfection of large flowering, new high colored sorts; their brilliancy and richness are most striking. ⅓ oz. \$2.50, ¼ oz. \$4.00	.50
6100	Grey's Special Mixture. A grand mixture of the finest varieties, and one of the richest ever sent out; very striking and recommended for market growing.....	¼ oz. \$2.00, oz. \$7.00 .25
6105	Bugnot's Superb Blotched. Very beautiful class of large flowers with broad blotches. Many of the upper petals are finely lined or veined; great diversity of the handsomest and rarest colors.....	¼ oz. \$2.00 .25
6110	Cassier's Giant Odier. A strain of great excellence, producing very large, rich and showy flowers.....	¼ oz. \$2.00 .25
6115	colossea venosa. Giant, round flowers in light, veined shades.....	⅛ oz. \$2.00 .50
6120	English Show. Selected compact strain of the finest large flowering sorts in splendid colors.....	¼ oz. \$2.50 .25
6125	Giant Trimardeau. Very showy and vigorous class; flowers of fine colors and enormous size.....	¼ oz. \$1.50, oz. \$5.00 .15
6130	Large Stained Parisian. Splendid mixture of very large flowers, in which white and yellow shades, with clearly defined eye, predominate.....	¼ oz. \$1.75 .25
6135	Masterpiece. Frilled edged, giant flowers of the richest colors.....	¼ oz. \$3.00 .25
6140	Matchless. English exhibition strain of immense size and substance in matchless variety of exquisite shades and art colors....	⅛ oz. \$3.00 .50

PANSY—Continued

No.		Pkt.
6145	Non Plus Ultra. Large size and finest colors. 1/4 oz. \$1.75, oz. \$6.00	\$0.25
6147	Swiss Giants, Mixed. Enormous size, very long stems; flowers 3- and 5-blotched. Special greenhouse variety..... 1/8 oz. \$2.00	.50
PANSY, Giant, in Separate Colors.		
6155	Collection of 6 Colors. Our selection.....	1.20
6160	Adonis. Light blue; beautiful... 1/4 oz. \$1.50	.25
6170	Brown Shades. With black eye. 1/4 oz. \$1.50	.25
6175	Cornflower Blue. One of the finest dark blues..... 1/4 oz. \$1.50	.25
6180	Fire King. Crimson, yellow edge. 1/4 oz. \$1.50	.25
6182	Gold Orange (St. Knud)25
6185	Golden Queen. Pure yellow... 1/4 oz. \$1.50	.25
6190	Golden Yellow. Dark eye..... 1/4 oz. \$1.50	.25
6195	Hortensia Red 1/4 oz. \$1.50	.25
6200	King of the Blacks. Velvety... 1/4 oz. \$1.50	.25
6205	Lord Beaconsfield. Violet, top petals shading off to white..... 1/4 oz. \$1.50	.25
6210	Mme. Perret. Mostly rose, ruby and crimson shades on white ground... 1/4 oz. \$1.50	.25
6215	Peacock. Peacock blue, white edge..... 1/4 oz. \$1.50	.25
6220	Psyche. Velvety violet, bordered with white; waved petals..... 1/4 oz. \$1.50	.25
6225	Ruby King. Extensive range of color from orange scarlet to pink..... 1/4 oz. \$1.50	.25
6230	Silver-edged. Purple, white edge. 1/4 oz. \$1.50	.25
6235	Snow Queen. Pure white..... 1/4 oz. \$1.50	.25
6240	Striped. Extra fine..... 1/4 oz. \$1.50	.25
6245	Violet. Fine violet blue..... 1/4 oz. \$1.50	.25
6250	Vulcan. Brilliant, dark red, with five large black spots; frilled edges..... 1/4 oz. \$2.50	.25
6255	White. Pure white, violet eye... 1/4 oz. \$1.50	.25

TUFTED PANSIES. See Viola cornuta.

6260	PASSIFLORA caerulea (Passionflower). Fast growing and free flowering, ornamental perennial climbers, with large, showy blue flowers, suitable for conservatory or outside in Summer..... 1/8 oz. 85c.	.25
------	--	-----

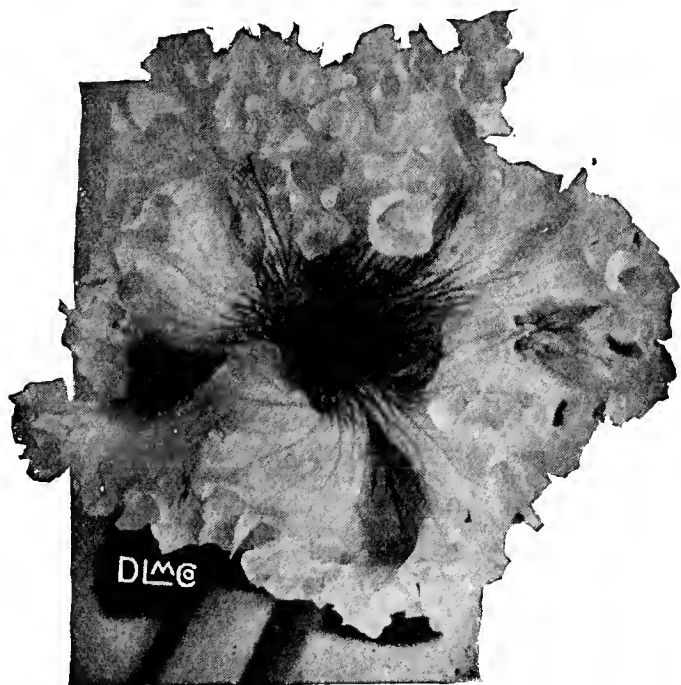

Petunia, Fringed Perfection

No.		Pkt.
	PENTSTEMON. Valuable class of perennials, but are best treated as annuals. Seeds sown in February or March will make a fine display the same season. 2 to 3 ft.	
6264	grandiflorum, Excelsior Mixed. Colors range from white to deepest scarlet.....	\$0.25
6265	Giant-flowering Hybrids. Superb strain saved from the finest large-flowered sorts; many new and rich colors... 1-16 oz. \$1.00	.25
6275	digitalis. Pure white with violet spotted throat..... 1/4 oz. 75c.	.10
6280	hartwegi albus. Large, pure white flowers..	.25
6285	murrayanus grandiflorus. Large, bright scarlet..... 1/8 oz. 85c.	.25
6290	speciosus. Extra deep blue..... 1/8 oz. 50c.	.10
6295	PERILLA atropurpurea laciniata. Dark bronzy purple fringed foliage; very ornamental hardy annual. 2 ft..... 1/4 oz. 35c.	.10
	PETUNIA. An exceedingly attractive and favorite hardy annual for both indoor and outdoor cultivation; when not in too rich soil they will flower most profusely through the Summer. 1 to 1 1/2 ft.	
6296	Balcony Blue20
6297	Balcony Crimson20
6298	Balcony Rose20
6299	Balcony White20
6301	Balcony Mixed20
6302	Dwarf Compact Fringed Rose25
6304	Dwarf Rose. 6 in..... 1/4 oz. \$1.25	.15
6305	Dwarf Striped. Beautiful. 6 in. 1/4 oz. \$1.25	.15
6310	Dwarf Pure White. Satiny white. 1/4 oz. \$1.25	.15
6315	Howard's Star. Rich, dark crimson, with five-pointed white star..... 1/4 oz. \$1.00	.15
6317	Rose of Heaven. A very dwarf, brilliant rose pink variety..... 1/8 oz. 75c.	.15
6325	Rosy Morn. Lovely, bright pink. 1/4 oz. \$1.50	.15
6327	Violet Blue50
6330	White. Pure white, free bloomer. 1/4 oz. 60c.	.10
6335	Striped and Blotched 1/4 oz. 50c., oz. \$1.50	.10
6340	Stupend Mixed. Rich colors, superb strain. 1/4 oz. 60c., oz. \$2.00	.10
	Grandiflora or Large-flowering Sorts.	
6345	Elk's Pride. Large, dark velvety, purple, plain edge.....	.25
6348	fimbriata caerulea. Fringed steel blue Petunia, deeper blue throat heavily veined; a very fine light blue sort.....	.50
6450	Fringed Perfection. Immense, deeply fringed flowers; exquisite colors.....	.25
6355	Superb California Giants. The flowers of this reselected strain are deep throated and very large, of great excellence and variety of colors.....	.25
6360	Superb Ruffled Giants. A California strain of extraordinary size and colors with deeply ruffled or fluted edges.....	.50
6362	New Dwarf California Giants. A very compact type of the Giant Petunia. Very large, well formed flowers. Specially recommended for pot culture. Throats well marked and veined.....	.75
6365	Snowstorm. Immense ruffled and fringed snow white flowers.....	.25
6366	Theodosia. Fringed, soft rose pink, large..	.50
6368	Rosy Morn. Double; same color and habit..	.50
6369	White Cloud. Compact bushes covered with pure white blooms. 12 in.....	.35
	Double Large-flowering Sorts. Seed saved from the most carefully hybridized flowers. The weaker seedlings should be carefully saved, as these invariably produce the finest double flowers.	
6370	Fringed, Grey's Select. One of the finest strains in existence. The double flowers are very large, full and beautifully formed..	.50
6375	grandiflora, Mixed. Choice strain.....	.25

- | No. | | Pkt. |
|------|--|------|
| 6380 | PHACELIA campanularia. Beautiful annual with rich, deep blue, bell-shaped flowers; blooms in about eight weeks from seed.
¾ ft. ¼ oz. 35c. \$0.10 | |
| | PHLOX drummondii. These beautiful, hardy annuals continue in bloom the whole of the Summer, and for bedding or massing nothing can surpass them for brilliancy and richness of color or profusion of flowers. 1 to 1½ ft. | |
| 6385 | grandiflora collection of 6 colors, separate | .50 |
| 6390 | Finest Mixed. An improved strain, with very large flowers and trusses; in brilliant colors. ¼ oz. 85c. | .10 |
| 6395 | Brilliant Scarlet. ¼ oz. 85c. | .10 |
| 6400 | Crimson. White star center. ¼ oz. 85c. | .10 |
| 6405 | Deep Blood Red. ¼ oz. 85c. | .10 |
| 6410 | Pink. Fine shade. ¼ oz. 85c. | .10 |
| 6415 | Pure White. ¼ oz. 85c. | .10 |
| 6417 | Salmon Pink. ¼ oz. 85c. | .10 |
| 6420 | Yellow. ¼ oz. 85c. | .10 |
| 6425 | cuspidata, Finest Mixed. Beautiful star-shaped flowers in showy colors. ¼ oz. 75c. | .10 |
| 6430 | Dwarf, Extra Mixed. An excellent, compact strain for pot culture or edgings, blooming early throughout the season. Finest colors. 6 in. ¼ oz. \$1.00 | .25 |
| 6433 | Apricot. ¼ oz. \$1.25 | .25 |
| 6435 | Bright Scarlet. ¼ oz. \$1.25 | .25 |
| 6440 | Daybreak Pink. ¼ oz. \$1.25 | .25 |
| 6445 | Pure White. ¼ oz. \$1.25 | .25 |
| 6446 | Yellow. ¼ oz. \$1.25 | .25 |
| 6455 | PHLOX decussata, Newest Hybrids. Tall growing, perfectly hardy plants with immense trusses of large and beautiful flowers in the greatest range of colors. 3 to 4 ft. ¼ oz. \$1.50 | .25 |

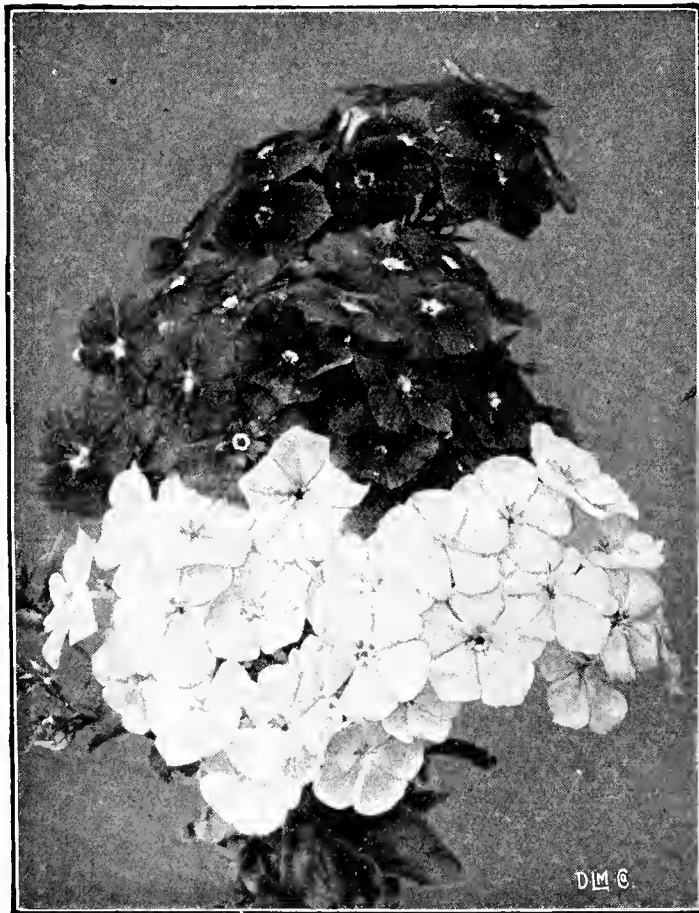

Phlox drummondii

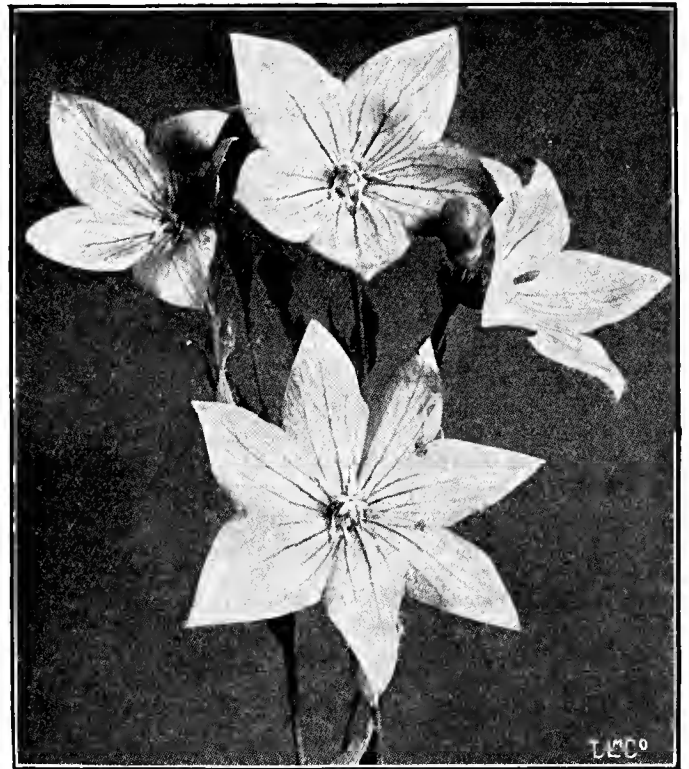

Platycodon

- | No. | | Pkt. |
|------|--|------|
| 6460 | PHORMIUM tenax foliis variegatis (New Zealand Flax). Handsome, decorative plant for greenhouse or garden. The rigid, erect leaves are often 6 ft. in length, narrow dark green, striped with rich yellow and white. The spikes of orange colored flowers are 8 to 12 ft. high. \$0.25 | |
| 6465 | PHYSALIS francheti (Japanese Winter-cherry). Hardy perennial, treated as an annual, fruiting first season from seed. A Japanese variety of the Groundcherry, with edible fruit in large, brilliant red capsules, which retain their color for months: fine for Winter decoration. 2 ft. ¼ oz. 75c. | .15 |
| 6470 | PHYSOSTEGIA virginica (Texas Heath). Fine hardy perennial, resembling a giant heather with beautiful pink flowers through the Summer. Fine for cutting. 2 ft. ¼ oz. \$1.00 | .15 |
| 6475 | virginica alba. Large white. ¼ oz. \$1.00 | .25 |
| | PINKS. See Dianthus. | |
| 6480 | PLATYCODON grandiflora. Handsome hardy perennial, with large, deep blue, bell-shaped flowers, from June to Oct; allied to the Campanula. 2 ft. ¼ oz. \$1.00 | .15 |
| 6485 | grandiflora alba. Large white. ¼ oz. \$1.00 | .15 |
| 6490 | mariesi. Dwarf, compact sort with rich blue flowers. 1 ft. ¼ oz. \$1.50 | .25 |
| 6495 | POLEMONIUM caeruleum, blue (Jacobs-ladder). Fine hardy perennials with large heads of showy flowers, easily grown in any good garden soil. May to August. 2 ft. ¼ oz. \$1.00 | .15 |
| | POPPIES, Single Annual Varieties. For hardiness and easy culture these showy plants cannot be surpassed. They are very free flowering and make a gorgeous display. | |
| 6500 | Admiral. Large, single, white, with a broad edge of bright scarlet. Oz. \$1.25 | .10 |
| 6505 | Danebrog. Single scarlet, with white blotch on each petal. Oz. 75c. | .10 |
| 6510 | English Scarlet. The common scarlet field Poppy. Oz. \$1.25 | .15 |
| 6515 | glaucum (Tulip Poppy). Vivid scarlet. 1 ft. ¼ oz. 25c. | .10 |

POPPIES, Single Annual—Continued

No.		Pkt.
6520	Shirley, Extra Selected. A much improved strain, with flowers of large size and from the most distinct and charming colors. The flowers are of a shining silky texture. 2 ft. ¼ oz. 25c., oz. 75c. \$0.10	
6523	Apricot. A beautiful shade. ⅛ oz. 40c. .15	
6525	Salmon Shades. ¼ oz. 60c. .15	
6530	The Bride. Large, pure white. 2 ft. oz. 75c. .10	
6535	umbrosum. Rich vermilion, with black spot at base of each petal. 1½ ft. oz. \$1.00 .10	
6540	Collection of 6 Single Varieties.50	

POPPIES, Double Annual Varieties.

6545	American Flag. Large, snow white, fringed flowers, bordered with scarlet. 2 ft. oz. \$1.00 .10	
6550	Cardinal Hybrids. Semi-dwarf, beautiful class, with large flowers in richest and brightest colors. 1½ ft. ¼ oz. 30c. .10	
6555	Carnation-flowered Mixed. Large, showy fringed flowers in choice colors. oz. 75c. .10	
6560	Japanese Pompon, Mixed. Beautiful, small double flowers. 1 ft. ¼ oz. 50c. .15	
6565	Mikado. Double white fringed petals, tipped with crimson. 2 ft. oz. 75c. .10	
6570	Peony-flowered Mixed. Immense globular flowers; in choice colors. 2 ft. oz. 75c. .10	
6575	Pink. Immense bright pink. oz. 85c. .10	
6580	Scarlet. Immense flowers. oz. 85c. .10	
6585	White. Immense, pure white. oz. 85c. .10	
6590	Yellow. Immense, clear yellow. oz. 85c. .10	
6595	Sweet Briar. New double Begonia-flowered Shirley Poppy. Deep rose pink.15	
6596	salmonium. Double Shirley in all salmon shades.15	
6600	White Swan. Dwarf white. 1 ft. ¼ oz. 35c. .10	
6605	Collection of 6 Double Varieties.50	

POPPIES, Hardy Perennial Varieties.

6610	Alpine, Mixed. Pretty, dwarf, free flowering sorts, in delicate colors. ½ ft.25	
6615	nudicaule, Single Mixed (Iceland Poppy). Beautiful border plant with bright, delicate colors, and if sown early will bloom the first year. 1 ft. ¼ oz. \$1.25 .20	
6620	Bright Yellow. ¼ oz. 1.25 .25	
6622	Iceland, Coonara Pinks. Mixed hybrids in various shades of pink and yellow. Introduced from Australia; will bloom the same season from early Spring sown seed. Strong stems and large flowers. . . .25	
6624	Iceland, El Monte. Very large, deep tangerine flowers borne on long, wiry stems. Comes true to color. Blooms in six months from seed. Fine as a cut flower. .25	
6625	Orange Scarlet. ¼ oz. \$1.25 .25	
6630	Pure White. ¼ oz. 1.25 .25	
6635	Double Mixed. All colors. ¼ oz. 1.50 .25	
6640	orientale. Very large, brilliant scarlet with black blotch. 3 ft. ¼ oz. 70c. .10	
6645	Blush Queen. Large, pale pink. ⅛ oz. 50c. .15	
6650	Livermere. Large deep crimson. ⅛ oz. 75c. .25	
6652	Mrs. Perry. Orange apricot.25	
6655	Queen Alexandra. Bright rosy salmon. . . .15	
6660	Royal Scarlet. Immense blooms. ⅛ oz. 50c. .15	
6665	Salmon Queen. Salmon yellow. ⅛ oz. 50c. .15	
6670	White. New large white.25	
6675	Hybrids. Many choice shades. ¼ oz. \$1.00 .15	

PORTULACA. One of our finest hardy annuals, specially adapted to light soils, dry, sunny situations and exposed rockeries. Flowers freely during the hottest weather. 6 in.

6680	Double-flowered, Mixed. Perfectly double flowers in brilliant and striking colors. ¼ oz. \$1.25 .25	
------	---	--



Iceland Poppies

No.	PORTULACA—Continued.	Pkt.
6685	Single-flowered, Mixed. Large flowers in most brilliant colors. ¼ oz. 60c., oz. \$2.00 \$0.10	
6690	Rose. ¼ oz. 60c., oz. 2.00 .10	
6695	Scarlet. ¼ oz. 60c., oz. 2.00 .10	
6700	White. ¼ oz. 60c., oz. 2.00 .10	
6705	Yellow. ¼ oz. 60c., oz. 2.00 .10	
6710	Collection of 4 colors, separate.35	

POTENTILLA. A showy class of hardy perennials, producing in great abundance rich colored flowers of velvety texture; July to October. 1½ to 2 ft.

6715	Double Hybrids, Mixed.25	
6720	Single Hybrids, Mixed. ¼ oz. 60c. .15	

PRIMULA or PRIMROSE. Hardy and half-hardy sorts. The following Primulas are exceedingly charming and useful plants for growing under glass or in the open air. Most of the hardy sorts require, in our climate, protection during Winter.

6725	auricula. Saved from a large and varied collection of choice colors.25	
6730	Garden Primrose, New Hybrids (Acaulis). An excellent, large flowering strain of bright colors. ⅛ oz. \$3.00 .25	
6735	Blue. Clear blue color.25	
6740	Yellow. English Primrose. ⅛ oz. \$1.50 .25	
6745	polyanthus, Giant Mixed. New, large flowering strain of the brightest colors. . . .25	
6750	Finest Fancy Mixed. Extra choice strain. .15	
6755	Gold Laced. Yellow edged sorts.15	
6759	Large-flowered Bedding Hybrids. Dwarf upright.25	

PRIMULA chinensis (Chinese Primrose). All chinensis and stellata Primroses are grown for us by an English specialist who grows nothing but Primulas. For excellence in every point they cannot be equaled.

6760	Grey's Giant Mixture. A mixture of giant Primroses. 1.00	
6765	Half packet of Giant Mixture.50	

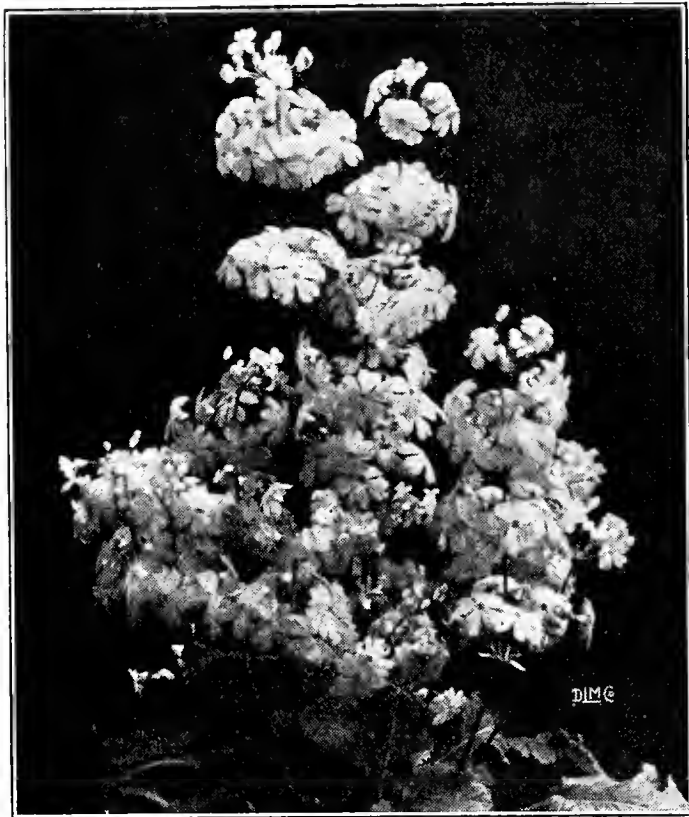

Primula malacoides

No.		Pkt.
PRIMULA chinensis—Continued		
6770	Grey's Giant White. The largest and best white ever sent out; flowers of great substance.	\$1.00
6775	Grey's Giant Pink. The finest and largest bright pink; petals extremely large and of great substance.	1.00
6780	Grey's Giant Crimson. Most lovely rich velvety crimson, fine habit, good substance and very free flowering.	1.00
6785	Grey's Giant Salmon. A distinct and valuable sort with massive trusses of salmon pink flowers well above the foliage.	1.00
6790	Grey's Giant True Blue. Beautiful fringed blossoms of immense size, fine substance and freely produced; the best blue.	1.00
6795	Grey's Orange King. A grand new sort, said to be an entirely new color in Primulas, a beautiful orange color in bud and when open of a terra cotta color shaded with orange salmon around the edge; very large and free.	1.00
6800	Giant Art Shade. One of the most lovely yet introduced. The immense blooms are fringed and curved; the color is an art shade of an intense fiery glare.	1.00
6805	Giant Brilliant King. Large and erect blooms, forming a pyramid of beautiful rich crimson flowers; superb sort.	.75
6810	Giant Chiswick Red. Improved strain, with large, beautifully fringed crimson scarlet flowers.	.75
6815	Giant Crimson King. The large deep rich crimson bloom with a dark brown eye make it one of the most brilliant and effective.	.75
6820	Giant Covent Garden White, Improved. Flowers very large, white and beautifully fringed; a very free flowering improved strain.	.75
6825	Giant Delicata. Free flowering beautiful soft pink, with very large erect blooms.	.75

No.		Pkt.
PRIMULA chinensis—Continued		
6830	Giant, His Majesty. Magnificent new sort, with distinct glossy foliage and massive, finely fringed velvety, dark crimson blooms; one of the finest ever raised.	\$0.75
6835	Giant King George V (New). The darkest crimson yet offered, of giant size, beautifully fringed, very free flowering and of massive substance.	.75
6840	Giant Queen Mary (New). One of the finest ever raised, erect, free flowering of great substance, and of a lovely delicate pink color.	.75
6845	Giant Ruby Queen. One of the finest of all the deep red sorts; the flowers are large finely fringed, and of an intense rich scarlet with bright yellow eye.	.75
6850	Giant Duchess. Most distinct and beautiful, having large pure white flowers with a zone of carmine crimson around a clear yellow eye.	.75
PRIMULA stellata, or Star Primrose. This valuable and very distinct variety should be extensively grown for greenhouse and table decoration. The innumerable star-shaped flowers make an effective contrast to the attractive dark foliage.		
6855	Blue Star Improved. A strain of very large dark blue flowers and pale green foliage.	.75
6860	Brilliant Rose Star. Bright rose flowers and graceful, dark green fern leaf foliage, which is red underneath.	.75
6865	Crimson Star. Fine colored sort with large, brilliant, rich crimson flowers.	.75
6870	King of Star. Deep crimson.	.75
6875	Salmon Pink Star. Improved strain.	.75
6880	White Star. Improved, large, pure white.	.75
6885	Mixed Star. A special mixture.	.75
PRIMULA obconica. A beautiful and continuous blooming variety with handsome spikes of flowers and pretty foliage. For Winter blooming, seed should be sown in April or May in good porous loam. The grandiflora sorts are the freest blooming, but the individual flowers are not as large as the gigantea type.		
6890	grandiflora alba. Large, pure white.	.25
6895	carminea. Large, carmine red.	.25
6900	hybrida. Finest giant flowered sorts, mixed.	.50
6905	Giant fimbriata. Giant fringed sorts.	.50
6910	Apple Blossom. Delicate pink.	.50
6915	Bright Rose.	.50
6920	lilacina. Dark lilac.	.50
6925	oculata. Dark-eyed varieties.	.50
6925	Rich Crimson.	.50
6927	Salmon. A fine shade.	.50
6940	forbesi (Baby Primrose). Rosy lilac, yellow-eyed flowers. Blooms in three months after sowing.	.25
6945	PRIMULA kewensis. A great acquisition as a Winter flowering decorative plant and excellent for cutting. The flowers are bright yellow, very fragrant, on erect stems 12 to 18 in. long.	.50
6950	PRIMULA malacoides. Very free flowering species from China and an excellent pot plant for indoor growing; the flowers are 1/2 to 3/4 in. across, of a light lilac color.	.25
6955	alba. Pure white.	.25
6960	rosea. Rose shades.	.25
6962	Pink Beauty. Rose pink shading mauve.	.30
6964	Snow Queen. Large pure white.	.35
6965	Superba. Deep pink, fine greenhouse var.	.30

No.		Pkt.
	PYRETHRUM. Handsome, hardy perennials, indispensable for herbaceous borders or for cutting. They grow best in cool, moist situations. 2 ft.	
6970	Double Hybrids, Mixed. Saved from a choice strain of double and semi-double flowers, in finest colors..... 1/8 oz. \$3.00	\$0.25
6972	Double Hybrids, Kelway's. Saved from their unequalled collection of named sorts.....	.50
6975	Single Hybrids, Mixed. Single Daisylike flowers in rich colors..... 1/4 oz. \$2.00	.20
6976	Single Hybrids, Kelway's. Superb large flowering sorts with immense single flowers of richest colorings..... 1/8 oz. \$1.50	.25
6985	PYRETHRUM aureum (Golden Feather). Bright golden foliage used extensively for Summer bedding, edgings and ribbon work. Treated as annuals. 3/4 ft..... 1/4 oz. 50c.	.15
6990	selaginoides. Bright golden, fernlike foliage..... 1/4 oz. 60c.	.10
6995	RANUNCULUS, Double Mixed French. Beautiful double Buttercuplike flowers in great variety of choice colors; flowering first season from seed; hardy with protection. 3/4 ft..... 1/4 oz. 75c.	.15
	RESEDA. See <i>Mignonette</i> .	
7000	RHODANTHE, Mixed. Handsome pink and white, annual everlasting; excellent for bouquets of dried flowers. 1 ft..... 1/4 oz. 40c.	.10
7005	manglesi. Bright pink; beautiful..... 1/4 oz. 60c.	.15
	RICINUS (Castor-oil Bean). Large, luxuriant, rapid growing foliage plants, with immense palmlike leaves and brilliant colored fruit. In center of beds or singly on lawns, they produce a fine effect; half hardy annual.	
7010	borboniensis. Large, purplish green leaves. 15 ft. oz. 40c.	.10
7015	camboagensis. Best dark-leaved sort. 6 ft..... oz. 40c.	.10
7020	gibsoni. Dark purple stems and foliage. 6 ft..... oz. 35c.	.10
7025	gibsoni mirabilis. Dwarf reddish foliage. Pkt. No.	
	4 ft..... oz. 35c.	.10
7030	sanguineus. Red stalks and fruit. 8 ft. oz. 30c.	.10
7035	zanzibarensis, Mixed. A distinct race with enormous leaves varying in color from pale green to brownish purple..... oz. 30c.	.10
7040	Mixed. All sorts..... oz. 25c.	.10
7045	ROMNEYA coulteri (Giant White California Poppy). A California perennial, with immense, pure white, fragrant flowers, with golden center, blooming continually from June to September; makes a fine pot plant and requires protection in Winter. The seed will sometimes remain dormant for months after planting. 3 ft.....	.15

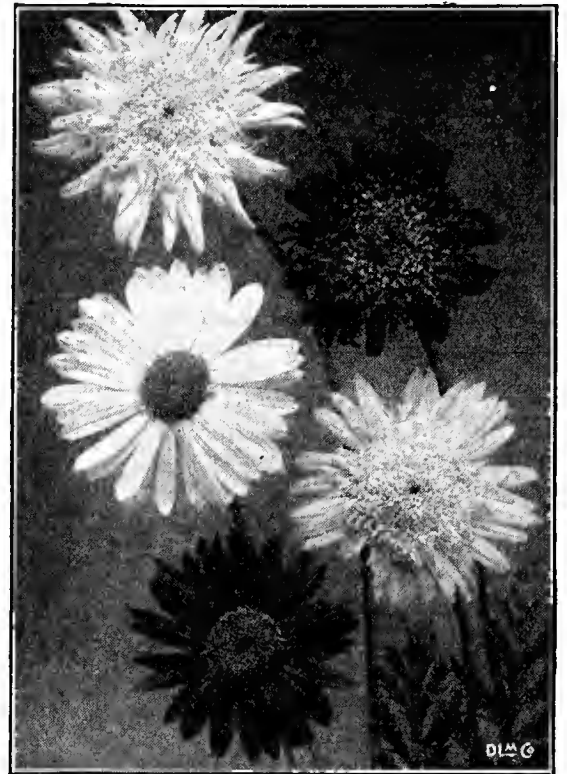

Pyrethrum Hybrids

No.		Pkt.
	RUDBECKIA (Coneflower). Beautiful border plants lasting a long time in bloom and excellent for Summer and Autumn display; each bloom is like a miniature Sunflower. 2 ft.	
7050	bicolor superba. Orange yellow with velvety brown center; annual..... 1/4 oz. 50c.	\$0.15
7055	newmanni. Golden yellow with velvety maroon center; hardy perennial.....	.15
	purpurea. See <i>Echinacea</i> .	
7060	SAINTPAULIA ionantha grandiflora. Charming greenhouse plant, with beautiful deep blue flowers, 1 1/4 in. in diameter, resembling the Violet.....	.25
	SALPIGLOSSIS, Improved Large-flowering. Very beautiful free flowering annuals in great variety of color. The large, richly colored flowers are elegantly veined, and penciled, blooming from July to frost, and are splendid for cutting. 2 ft.	



Salpiglossis

7063	Light Blue and Gold. Large..... 1/4 oz. \$1.00	.15
7065	Purple, Golden Veined. Large..... 1/4 oz. \$1.00	.15
7070	Rose, Golden Veined. Large..... 1/4 oz. \$1.00	.15
7075	Scarlet, Golden Veined. Large..... 1/4 oz. \$1.00	.15
7080	Large-flowering, Mixed 1/4 oz. 85c.	.15
7085	Emperor, Mixed. A robust class, with only one leading stem covered with immense flowers of richest colors..... 1/4 oz. \$1.00	.15
7090	Dwarf, Mixed. New class, 12 to 15 in. high, with larger flowers more freely produced than the tall growing.....	.25
7095	Collection of 4 colors, separate45
	SALVIA. One of our handsomest and most showy Summer and Autumn flowering plants forming compact bushes, which are literally ablaze with brilliant flowers from July to frost.	
7098	America (Globe of Fire)..... 1/8 oz. \$1.25	.25
7100	farinacea. Remarkable for its long flower spikes of lavender blue. 3 ft..... 1/8 oz. \$1.00	.15
7105	patens. Rich blue. 2 ft..... 1/8 oz. \$1.75	.25
7110	splendens, Bonfire. Finest compact sort of very even growth, with dense spikes of vivid dark scarlet flowers. 2 1/2 ft..... 1/4 oz. \$1.50	.20
7115	splendens, Fireball. Compact sort, with large, scarlet flower spikes, early and rich flowering. 2 ft.. 1/4 oz. \$1.75	.20

No. **SALVIA**—Continued

No.		Pkt.
7120	splendens grandiflora. Large, brilliant scarlet flower spikes. The most popular sort grown. 3 ft.....	¼ oz. \$1.00 \$0.10
7122	splendens, Harbinger. Dwarf compact dazzling scarlet, dark foliage. Seed planted in February will flower in June.....	.30
7125	splendens lilliputiana. Compact, globular habit. Scarlet. 10 in....	.25
7130	splendens, Ostrich Plume. The spikes of flowers are like plumes; of the brightest scarlet, and the bush is well covered: each plume is a bouquet in itself.....	.25
7135	Zurich. The very earliest flowering variety; it is of a rich scarlet and suitable for pot growing, as it is very dwarf. 1 ft. ⅛ oz. \$1.25	.25
7140	SANVITALIA procumbens fl. pl. Pretty, free flowering hardy annual, with double flowers of a bright yellow. 9 in.....	¼ oz. 75c. .15
SAPONARIA. A beautiful class of compact growing, hardy annuals, with small, starry flowers from July to September; suitable for beds or borders and fine for cutting.		
7145	vaccaria. Profuse blooming, with beautiful pink feathery flowers. 3 ft.....	¼ oz. 20c. .10
7150	vaccaria alba. White-flowered; a fine market flower.....	¼ oz. 20c. .10



Schizanthus

No.		Pkt.
SCABIOSA, Improved Large-flowering (Mourning Bride). One of our best Summer flowering annuals. The rich and beautifully colored flowers are very handsome and excellent for cutting; profuse bloomer. June to October. 2½ ft.		
7155	Azure Fairy. Delicate mauve....	¼ oz. 50c. \$0.10
7160	Cherry Red. Bright color.....	¼ oz. 50c. .10
7165	Fiery Scarlet. Brilliant color....	¼ oz. 50c. .10
7170	King of Blacks. Black purple....	¼ oz. 50c. .10
7172	Giant Loveliness. Flowers salmon rose shades. Fragrant. Strong stems.....	.25
7175	Rose Pink. Beautiful shade.....	¼ oz. 50c. .10
7178	Peach Blossom. Peach blossom pink.....	.20
7180	Purple, Edged White	¼ oz. 50c. .10
7182	Shasta. Enormous white Californian variety.	.20
7185	White. Large pure white.....	¼ oz. 50c. .10
7190	Mixed. All colors.....	¼ oz. 50c. .10
7195	Collection of 6 colors. Our selection.....	.50



Scabiosa, Giant Loveliness

No.		Pkt.
SCABIOSA, Hardy Perennial Varieties. Of great value either in the herbaceous border or for cutting. 2 ft.		
7200	caucasica. Beautiful lilac blue. ¼ oz. \$2.50	\$0.15
7202	Columbaria. A low growing pink Scabiosa, very large flowers.....	.30
7203	caucasica, Isaac House Strain. Giant Hybrids. A very much improved variety....	.35
7205	Large-flowered Hybrids25
SCHIZANTHUS (Butterflyflower). Beautiful annuals for house or garden. 1½ ft.		
7210	hybridus grandiflorus. Very fine new, large flowered varieties in very effective colors. ⅛ oz. 75c.	.15
7215	Giant Hybrids (Garaways). A beautiful strain for greenhouse.....	.50
7220	wisetonensis. Containing the most delicate shades of white, pink, rose and crimson; excellent for pot culture.....	⅛ oz. \$2.00 .25
7225	albus. Glistening snow white; very compact. 16 in.....	.25
7226	Snowflake. Compact, pyramidal habit. Pure white frilled edges.....	.25
7228	Pink Pearl25
7229	roseus compactus. A fine greenhouse var..	.60
7230	SCHIZOPETALON walkeri. Hardy annual, producing quantities of white, almond-scented flowers, which are elegantly fringed at edges. June to October. 1 ft.....	.15
7235	SEDUM (Stonecrop). Mixed. Suitable for rockwork, edgings and dry situations; their glaucous foliage and bright flowers invariably attract attention; hardy perennial. 4 in.....	⅛ oz. \$1.25 .20
7238	acre. Bright yellow. 3 in., hardy.....	.25
7240	coeruleum. Blue-flowered annual variety...	.25
7245	SHAMROCK. True, small leaved variety; imported seed.....	¼ oz. 50c. .10
7248	SIDALCEA hybrida (New). Hardy 2½ to 3 ft. June-July. In many shades of rose, pink, red, salmon, lilac and heliotrope.....	.25
SILENE (Catchfly). Very pretty and profuse blooming plants.		
7250	armeria, Mixed. Free flowering, hardy annual, with pink, white and red flowers. 1 ft.....	¼ oz. 25c. .10
7255	pendula, Peach Blossom. Beautiful bright pink annual variety for Spring bedding, edgings, etc.....	¼ oz. 35c. .10
7260	orientalis. Fine, hardy perennial with large, globular heads of beautiful pink flowers; blooms from June to August and is fine for cutting; flowers first season from seed. 2½ ft.....	¼ oz. 50c. .10

No.		Pkt.
7265	SMILAX (<i>Myrsiphyllum asparagoides</i>). A climbing plant unsurpassed for its graceful foliage and orange blossom fragrance of its flowers..... $\frac{1}{4}$ oz. 35c.	\$0.10
7270	Myrtle-leaved. New and distinct form, more graceful than preceding.....100 seeds 75c.	.20
	SNAPDRAGON. See Antirrhinum.	
7275	SOLANUM capsicastrum nanum (Jerusalem Cherry). Very ornamental plants for house or greenhouse, being almost completely covered with bright scarlet berries. Early Spring sown seed will produce fruiting plants in the Autumn. 1 ft. $\frac{1}{4}$ oz. 50c.	.10
7280	Cleveland. Very large, brilliant berries. A fine decorative plant.....	.15
7285	STATICE (Sea-lavender). Mixed. Beautiful hardy perennial.....	.10
7290	latifolia. Deep lavender blue..... $\frac{1}{8}$ oz. 40c.	.10
7291	sinuata Blue. Annual varieties..... $\frac{1}{4}$ oz. 40c.	.15
7292	sinuata Rose $\frac{1}{4}$ oz. 40c.	.15
7293	sinuata White $\frac{1}{4}$ oz. 40c.	.15
7293A	suworowii (Russian Statice). Annual. Tail-like spikes of pink flowers.....	.15
7294	bonduelli. Yellow.....	.15
	STEVIA. Free flowering greenhouse perennials, with sprays of tiny flowers. 2 ft.	
7295	eupatoria. Fine pinkish white... $\frac{1}{8}$ oz. 35c.	.10
7300	serrata. Pure white, fragrant.....	.15
	STOCKS (Gilliflower). One of the most highly prized of all our cultivated flowers. The delightful fragrance, free-blooming character and beautiful colors have made them as desirable for Winter cultivation in the greenhouse as for the garden in Summer.	
7303	Imperial Golden Rose. Giant early rich bright rose, golden sheen center. $\frac{1}{8}$ oz. \$1.50	.35

LARGE-FLOWERED DOUBLE GIANT PERPETUAL PERFECTION (Cut-and-come-again). An excellent variety of fine branching habit, with large double flowers in great abundance from June till frost. 1 $\frac{1}{2}$ ft.

7305	Apple Blossom Pink $\frac{1}{8}$ oz. \$1.25	.15
7310	Bright Rose $\frac{1}{8}$ oz. 1.25	.15
7315	Canary Yellow $\frac{1}{8}$ oz. 1.25	.15
7320	Dark Blood Red $\frac{1}{8}$ oz. 1.25	.15
7325	Dark Blue $\frac{1}{8}$ oz. 1.25	.15
7330	Light Blue $\frac{1}{8}$ oz. 1.25	.15
7335	Scarlet $\frac{1}{8}$ oz. 1.25	.15
7340	Snow White $\frac{1}{8}$ oz. 1.25	.15
7345	Mixed, Extra $\frac{1}{8}$ oz. 1.25	.15
7350	Collection of 6 colors. Our selection.....	.75

SPECIAL LARGE-FLOWERING PERFECTION OF NICE, TEN-WEEKS. Splendid strain for garden or greenhouse, of fine branching habit, with very large, double fragrant flowers. An unusually long and free blooming strain. 2 ft.

7351	Collection of Six Separate Colors	1.20
7352	Almond Blossom. Shell pink... $\frac{1}{8}$ oz. \$1.00	.25
7353	Apricot Special Forcing. 2 $\frac{1}{2}$ to 3 ft. Soft apricot, delicately-tinged pink, large and fragrant.....	.50
7354	Belle of Naples. Old rose..... $\frac{1}{8}$ oz. \$1.00	.25
7355	Beauty of Nice. Delicate flesh pink..... $\frac{1}{8}$ oz. 1.00	.25
7358	Mont Blanc. White..... $\frac{1}{8}$ oz. 1.00	.25
7362	Cote d'Azur. Light blue..... $\frac{1}{8}$ oz. 1.00	.25
7365	Crimson King. Rich crimson... $\frac{1}{8}$ oz. 1.00	.25
7370	Monte Carlo. Yellow..... $\frac{1}{8}$ oz. 1.00	.25
7375	Queen Alexandra. Mauve..... $\frac{1}{8}$ oz. 1.00	.25
7377	Violet of Nice. Dark violet..... $\frac{1}{8}$ oz. 1.00	.25

No.		Pkt.
	MAMMOTH COLUMN TEN-WEEKS. Splendid variety; earliest flowering of the Ten-Weeks Stocks; produces only one spike of large, double flowers. 2 $\frac{1}{2}$ ft.	
7380	Crimson $\frac{1}{8}$ oz. \$2.00	\$0.15
7390	Light Blue $\frac{1}{8}$ oz. 2.00	.15
7395	Rose Pink $\frac{1}{8}$ oz. 2.00	.15
7400	Snow White $\frac{1}{8}$ oz. 2.00	.15
	DWARF BOUQUET TEN-WEEKS. Dwarf Stock for growing in pots. 8 in.	
7405	Crimson. Fine deep color..... $\frac{1}{8}$ oz. \$1.00	.15
7408	Dark Blue $\frac{1}{8}$ oz. 1.00	.15
7410	Pure White. Excellent..... $\frac{1}{8}$ oz. 1.00	.15
7412	Light Blue $\frac{1}{8}$ oz. 1.00	.15
7414	Light Rose $\frac{1}{8}$ oz. 1.00	.15
7415	Mixed. All colors..... $\frac{1}{8}$ oz. 1.00	.15
7420	STOKESIA cyanea (Cornflower Aster). Beautiful hardy perennial with lavender blue blossoms July to frost. 2 ft.... $\frac{1}{4}$ oz. \$1.50	.25
7424	cyanea. Mixed15
7425	STREPTOCARPUS, Veitch's New Hybrids. Handsome greenhouse perennial, with Achimene-like flowers in clusters on slender stems. Treatment same as for Gloxinia...	.75
	SUNFLOWER. See Helianthus.	
	SWAINSONA. Fragrant, tender perennial for house or conservatory. Graceful foliage and Sweet Pea-like flowers. Grown as a climber or trimmed into bush form. Usually grown in pots.	
7434	grandiflora. Finest Mixed.....	.50
	SWEET CLOVER. Grown for the fragrance of their flowers and foliage.	
7440	melilotus alba. Yellowish white; very fragrant; hardy biennial. 3 ft.....Oz. 30c.	.10
7445	coerulea. Blue flowers; very sweet, hardy annual. 2 ft.....Oz. 50c.	.10

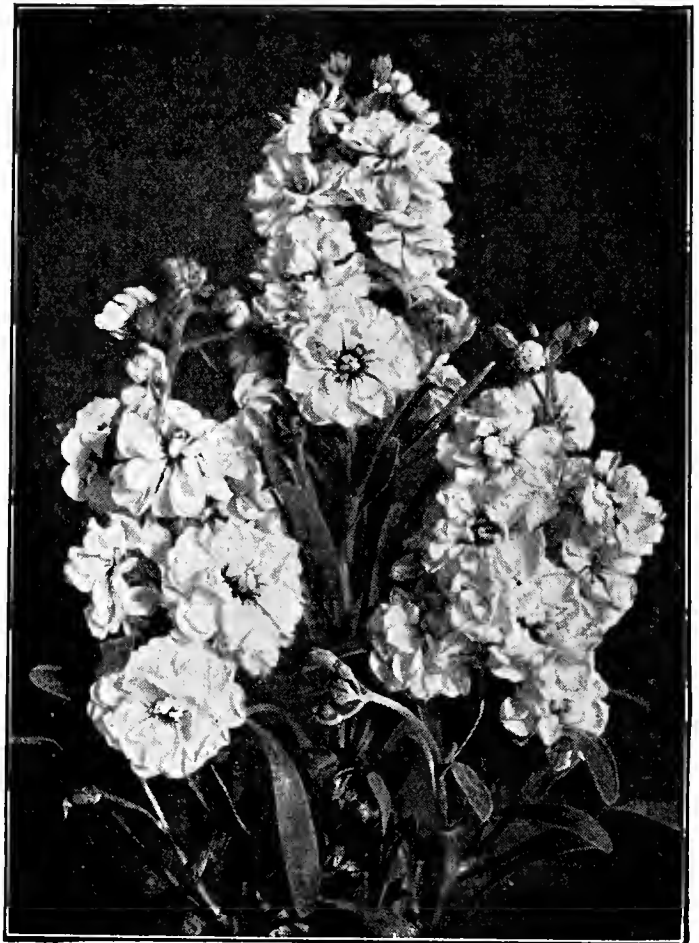

Stocks, Large-flowered Double Ten-Weeks

SWEET PEAS

No.		Pkt.
	GIANT SPENCER or ORCHID FLOWERING. Unquestionably the finest type of this most popular flower that has ever been introduced. The waved flowers are of immense size, usually 2 in. or more across and with three to five flowers on a stem. The season of bloom is much longer than the old type. Grow 3 or 4 in. apart in the rows.	
7450	Special Exhibition Mixture. This mixture is made up entirely of the Spencer and Unwin types and includes the finest sorts and most effective colors; it is without an equal and cannot fail to give the greatest satisfaction. Oz. 35c., ¼ lb. \$1.00, lb. \$3.25 \$0.10	
	Separate Varieties. Oz. 50c., ¼ lb. \$1.50, unless otherwise priced.	
7455	America. Red flaked, white ground.....	.10
7460	Angele. Blue mauve, suffused pink.....	.10
7465	Austin Frederick Improved. Giant true lavender.....	.10

No.		Pkt.
7470	Avalanche. Glistening white.....	\$0.10
7475	Barbara. Large salmon.....	.10
7480	Bonfire. Bicolor cherry pink, cream wings..	.10
7485	Campfire. Bright scarlet.....	.10
7490	Carmelita. Rose pink flushed on white ground.....	.10
7495	Carnival. Rose pink on cream ground..	.10
7500	Charity. Crimson.....	.10
7505	Charming. Deep cerise.....	.10
7510	Chieftain. Deep satiny mauve.....	.10
7515	Colorado. Bright orange.....	.10
7520	Constance Hinton. Mammoth white, black seeded.....	.10
7525	Countess Spencer. Rich pure pink....	.10
7530	Crimson King. Deep crimson.....	.10
7535	Defiance. Orange scarlet.....	.10
7540	Del Monte. Pelargonium pink.....	.10
7545	Dora. Bicolor rosy cerise, cream wings..	.10
7550	Doreen. Carmine.....	.10
7555	Flamingo. Scarlet cerise.....	.10
7560	Fortune. Dark blue.....	.10
7565	Gleneagles. Light blue lavender.....	.10
7570	Glengary. Deep velvety crimson. Mammoth ruffled and duplexed.....oz. 60c.	.15
7575	Gold Crest. Orange, tinted salmon.....	.10
7580	Hawlmark Cerise10
7585	Hawlmark Lavender10
7590	Hawlmark Pink10
7595	Hawlmark Salmon10
7600	Hawlmark Scarlet10
7605	Heavenly Blue. Delphinium blue.....	.10
7610	Hebe. Bright pink.....	.10
7615	Huntsman. New shade scarlet.....	.10
7620	Idyl. Salmon pink on cream ground....	.10
7625	King White. Giant pure white.....	.10
7630	Kitty Pierce. Lilac, suffused pink.....	.10
7635	Magnet. Deep cream pink.....	.10
7640	Mammoth. Orange scarlet.....	.10
7645	Mary Pickford. Dainty cream pink suffused salmon.....	.10
7650	Matchless. Clear cream.....	.10
7355	Mermaid. Blue lavender.....	.10
7658	Miss Delight. Warm salmon pink on cream ground; waved and duplexed..oz. 60c.	.15
7660	Model. Large white, black seeded.....	.10
7665	Mrs. A. Searles. Pink, merging to red..	.10
7670	Mrs. Tom Jones. Bright Delphinium blue.....	.10
7675	Olympia. Deep purple.....	.10
7680	Picture. Rich pink, shaded creamy apricot.....	.10
7685	Pinkie. Large rose pink.....	.10
7690	Powerscourt. Lavender.....	.10
7695	Rosabelle. Giant deep rose self.....	.10
7700	Reflection. Clear blue.....	.10
7702	Ripples. Rose pink, wavy and semi-duplex.....oz. 60c.	.15
7705	Royal Pink10
7710	Royal Purple10

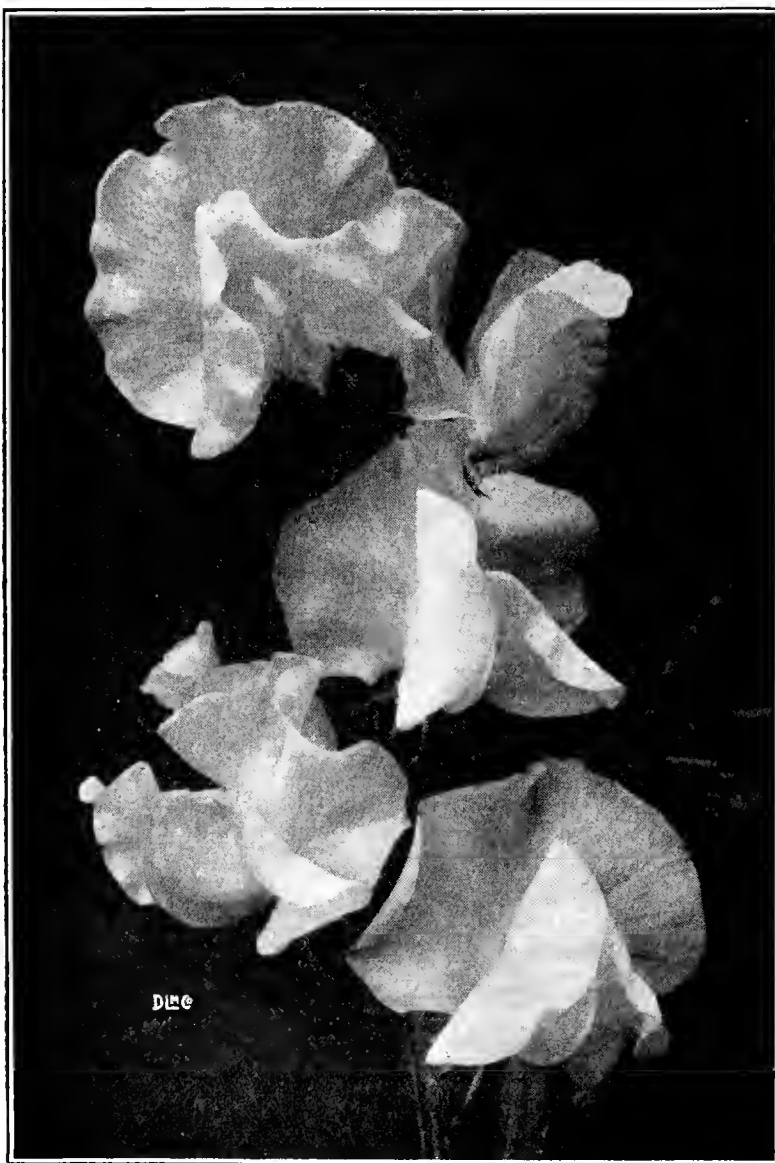

Sweet Peas, King White

No.	SWEET PEAS—Continued	Pkt.
7715	Royal Scot. Orange scarlet.....	\$0.10
7720	Royal Sovereign. Orange.....	.10
7722	Serenade. Bright cerise.....oz. 60c.	.15
7725	Splendour. Red maroon.....	.10
7730	Sunkist. Cream picotee rose.....	.10
7735	Supreme. Blush pink.....	.10
7740	Sybil Henshaw. Deep crimson.....	.10
7745	Tangerine Improved. Glowing orange.....	.10
7750	The Sultan. Black maroon.....	.10
7755	Warrior. Giant maroon.....	.10
7760	Wembley. Lavender blue.....	.10
7765	What Joy. Primrose yellow.....	.10
7770	Winnie Morse. Duplex frilled, cream ground, flushed rose.....oz. 60c.	.15
7775	Youth. White picotee rose.....	.10

SPENCER VARIETIES FOR GREENHOUSE.

All white seeded varieties will germinate better if sown in small pots of sand, being less liable to decay and can readily be transplanted to permanent place.

¼ oz. 35c., oz. \$1.00, each, unless priced.

7805	Amethyst. Royal purple.....	.15
7810	Aviator. Dazzling crimson scarlet.....	.15
7812	Ball Orange. Rich, deep color.....	.15
7813	Blaze. Glistening fiery orange.....oz. \$1.25	.20
7815	Bluebird. Violet blue.....	.15
7818	Blue Bonnet. Extra large, clear blue..oz. \$1.25	.20
7820	Burpee's Orange.15
7825	Columbia. Salmon rose, with white wings.....	.15
7830	Edward Zvolanek. Giant lavender.....	.15
7832	Eldorado. Rich salmon orange.....oz. \$1.25	.20
7835	Glitters. Cerise.....	.15
7840	Grenadier. Dazzling scarlet.....	.15



Sweet Peas, Pink Profusion

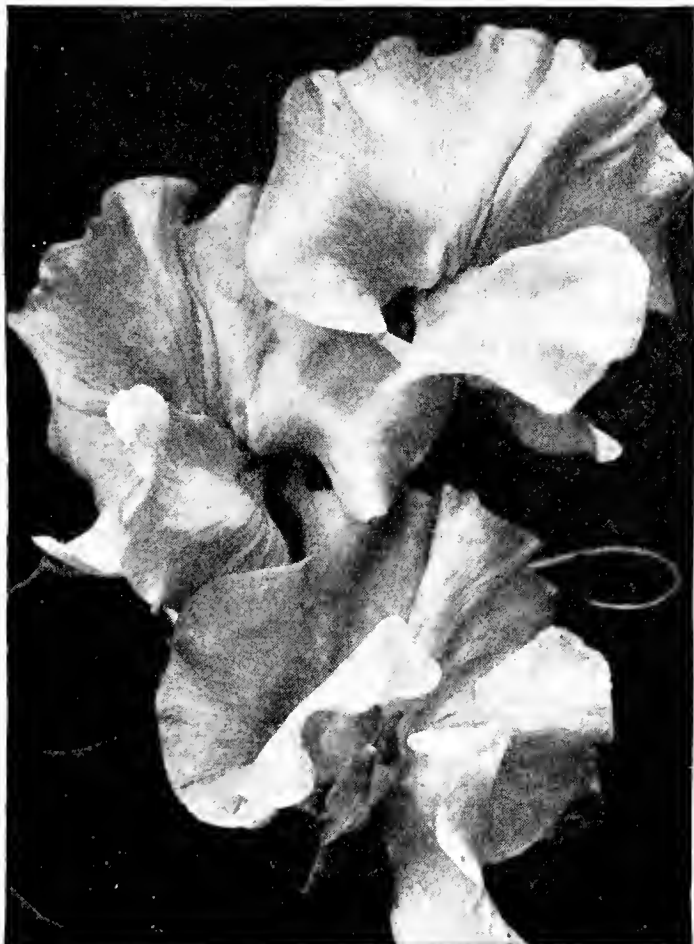

Winter-flowering Spencer Sweet Pea, Blue Bonnet

No.	SWEET PEAS—Continued	Pkt.
7842	Hope. Mammoth black seeded white. oz. \$1.50	\$0.20
7843	Laddie. Rose pink, white ground....oz. \$1.25	.20
7845	Lavender Harmony. Clear lavender.....	.15
7852	Majestic Rose. Brilliant deep rose...oz. \$1.50	.20
7855	Miss Louise Gude. Brilliant pink.....	.15
7860	Mrs. Kerr. Salmon.....	.15
7865	New Blue. Deep blue.....	.15
7870	Pink Profusion. Rich pink.....	.15
7872	Red Cross. Glowing Poppy scarlet...oz. \$1.25	.20
7875	Snowstorm Improved. Pure white.....	.15
7880	Springsong. Salmon pink.....	.15
7892	Valencia. Bright orange, sunproof...oz. \$1.25	.20
7895	White Harmony. Black seeded white.....	.15
7905	Zvolanek's Rose.15
7910	Mixed, All Varieties.¼ lb. \$1.50, oz. 50c.	.15

SWEET ROCKET. See *Hesperis*.

SWEET-SULTAN. See *Centaurea*.

SWEET-WILLIAM. Popular and showy hardy biennial of easiest culture, producing their brilliant colored flowers in great profusion; very desirable for borders and old-fashioned gardens. 1½ ft.

8055	Boston Giant. An extraordinary strain with flowers as large as a half dollar and contains colors not in other strains.....	.25
8060	Double Mixed. Very large flowers in choice colors.....¼ oz. 75c.	.15
8065	Holborn Glory. Extra large flowers, finest colors, with clearly defined eyes.....¼ oz. 50c.	.10

SWEET-WILLIAM—Continued

No.		Pkt.
8070	Single Finest Mixed. Choice... $\frac{1}{4}$ oz. 50c.	\$0.10
8075	Dark Crimson $\frac{1}{4}$ oz. 50c.	.10
8080	Deep Velvety Maroon $\frac{1}{4}$ oz. 75c.	.10
8085	Pure White $\frac{1}{4}$ oz. 75c.	.10
8090	Pink Beauty. Soft pink..... $\frac{1}{8}$ oz. 75c.	.25
8095	Sutton's Scarlet. Vivid..... $\frac{1}{8}$ oz. 75c.	.25
8100	Annual Mixed. Flowers of good size and well marked; seed sown in March will bloom the same year. 9 in..... $\frac{1}{4}$ oz. 75c.	.15
TAGETES. See Marigold.		
THUNBERGIA (Black-eyed-susan). Beautiful free flowering annual twiners of rapid growth; used extensively in window boxes, vases, etc. 4 ft.		
8105	alata. Yellow, with dark eye... $\frac{1}{4}$ oz. 65c.	.10
8110	alba. White, with dark eye... $\frac{1}{4}$ oz. 65c.	.10
8115	aurantica. Orange, with dark eye..... $\frac{1}{4}$ oz. 65c.	.10
8120	Mixed. All colors..... $\frac{1}{4}$ oz. 50c.	.10
TORENIA. Beautiful free flowering, tender annuals, suitable for pot culture in house or conservatory, also excellent for the border during the Summer, and for baskets and vases are unsurpassed. June to October. 1 ft.		
8125	bailloni. Golden yellow, purple throat....	.25
8130	fournieri grandiflora. Bright blue, with dark blue spots and bright yellow throat.	.25
8135	White Wings. Blush-white, yellow throat.	.25
8140	TRITOMA semperflorens (Flame Flower). Perpetual flowering, showy perennial, with numerous spikes of orange red flowers from July until frost; excellent for beds or borders. 3 to 4 ft.....	.15
8145	hybrida mirabilis. New dwarf annual strain ranging in color from lemon yellow to deep orange. Sown early and planted out in May, they bloom freely from July until frost. 2 ft.....	.15
TROLLIUS (Globoseflower). Charming Spring flowering, hardy perennials, with large globular Buttercup-like flowers varying in color from creamy white to orange. 2 ft.		
8150	Orange Globe. Large, deep orange.....	.25
8155	Mixed Hybrids. Newest large flowered varieties.....	.25



Sweet-william

No.		Pkt.
8160	TROPAEOLUM canariense (Canary-creeper). Well-known climbing annual with elegantly fringed, bright yellow flowers. 10 ft. Oz. 50c.	\$0.10
8165	VALERIAN, Mixed. Showy, hardy perennial, with long spikes of heliotrope-scented flowers. 2 ft..... $\frac{1}{4}$ oz. 35c.	.10
8170	officinalis (Garden Heliotrope). Large trusses of fragrant pink flowers. 3 ft....	.25
VERBENA. These are invaluable for Summer bedding purposes. Seed sown in March will commence to bloom in June and continue until frost. 1 $\frac{1}{2}$ ft.		
8175	Grey's Mammoth, Mixed. A grand strain of giant Verbenas, with flowers and trusses of exceptional size.... $\frac{1}{4}$ oz. 75c., oz. \$2.50	.10
8180	grandiflora Helen Willmott. Large, bright salmon-pink. with white eye.....	.20
8185	Mammoth Auricula-flowered, Mixed. Large flowers, with white eye... $\frac{1}{4}$ oz. 60c.	.10
8190	Blue, White Eye $\frac{1}{4}$ oz. 75c., oz. \$2.50	.10
8192	Giant Salmon Pink $\frac{1}{4}$ oz. 75c.	.15
8195	Rosea stellata. Rose, white eye..... $\frac{1}{4}$ oz. 75c., oz. \$2.50	.10
8196	Rose Queen $\frac{1}{8}$ oz. 60c.	.20
8197	Royale hybrida. Deep royal blue, yellow center..... $\frac{1}{8}$ oz. \$1.00	.20
8200	Scarlet Lucifer $\frac{1}{4}$ oz. 75c., oz. \$2.50	.10
8202	Scarlet Queen $\frac{1}{8}$ oz. 60c.	.20
8203	Snow Queen $\frac{1}{8}$ oz. 60c.	.20
8205	Striped Italian $\frac{1}{4}$ oz. 75c., oz. \$2.50	.10
8210	White $\frac{1}{4}$ oz. 75c., oz. \$2.50	.10
8215	Lemon Verbena (Aloysia citriodora). Fragrant foliage for cutting.....	.25
8222	venosa. Half hardy perennial. Purple flowers..... $\frac{1}{4}$ oz. 50c.	.15
VERONICA. Splendid hardy perennials, with showy spikes of bright colored flowers; fine border plant. 1 $\frac{1}{2}$ to 2 ft.		
8225	spicata Blue. Bright blue.....	.20
8227	spicata, Mixed20

No.

Pkt.

VINCA. Handsome, profuse blooming half-hardy perennials, flowering the first season from seed. They have dark green foliage and pretty pink and white flowers; excellent for borders and bedding out. 1 ft.

8235	Bright Rose $\frac{1}{4}$ oz. 75c., oz. \$2.50	\$0.15
8240	Pure White $\frac{1}{4}$ oz. 75c., oz. \$2.50	.15
8245	White, with Rose Eye ... $\frac{1}{4}$ oz. 75c., oz. \$2.50	.15
8250	Mixed. All colors..... $\frac{1}{4}$ oz. 75c., oz. \$2.50	.15

VIOLA cornuta (Tufted Pansies). Fine flowering plants, excellent for partially shaded beds or borders, blooming throughout the season; more hardy than other Pansies, but with smaller flowers.

8255	Admiration. Rich, dark blue... $\frac{1}{4}$ oz. \$1.75	.15
8260	Blue Perfection. Light blue... $\frac{1}{4}$ oz. \$1.75	.15
8265	lutea. Old yellow sort..... $\frac{1}{4}$ oz. \$1.50	.15
8270	rosea. Delicate rose..... $\frac{1}{4}$ oz. \$1.75	.15
8275	White Perfection. Large white... $\frac{1}{4}$ oz. \$1.50	.15
8280	Mixed. Finest varieties..... $\frac{1}{4}$ oz. \$1.25	.15
8285	Scotch Strains. Choicest and newest bedding hybrids in finest colors.....	.25
8287	Sutton's Bedding Apricot. Rich apricot tinged orange center.....	.50



Verbena



Zinnia

- | No. | | Pkt. |
|------|---|-----------------------------|
| 8288 | VIOLA Jersey Gem. A large, compact growing variety, continuous bloomer, deep violet-blue; a fine rockery and border plant.... | \$0.50 |
| | VIOLA odorata (Sweet-scented Violet). A favorite hardy perennial much in demand on account of its abundant and fragrant blossoms. Easily grown from seed, doing best in a cool, moist situation. | |
| 8295 | The Czar. Very large dark blue. | 1/8 oz. 85c. .15 |
| 8300 | White Czar. Very large white. | 1/8 oz. 75c. .15 |
| 8305 | Mixed. Blue and white shades. | 1/8 oz. 50c. .10 |
| 8310 | VIRGINIAN STOCK, Mixed. Early free flowering hardy annual, with bright colored flowers; doing well in any soil. | 1/4 oz. 75c. .15 |
| 8315 | VISCARIA, Finest Mixed. Remarkably showy, free flowering hardy annual, for border or masses. The bright flowers are continued through the season. | 1 ft. 1/4 oz. 25c. .10 |
| | WALLFLOWER. Deliciously fragrant half-hardy perennials, with beautiful velvety flowers, mostly in the rich dark colors. 2 ft. | |
| 8320 | Double Branching, Mixed. | 1/4 oz. \$1.50 .25 |
| 8325 | Kewensis. Very fragrant flowers varying from sulphur-yellow to orange and purple-violet. Sown in July, it blooms constantly from November until Spring. | 1/4 oz. \$1.50 .25 |
| 8330 | Vulcan. Extra large, velvety crimson-brown flowers. | 1/4 oz. 60c. .15 |
| | WALLFLOWER, Annual. A new strain of early flowering single varieties which bloom throughout the Summer from Spring-sown seed, and are excellent for bedding purposes. 2 ft. | |
| 8335 | Blood Red. | 1/4 oz. 50c. .25 |
| 8340 | Earliest Paris. Fine brown. | 1/4 oz. 50c. .25 |
| 8345 | Golden Yellow. | 1/4 oz. 50c. .25 |
| 8350 | Mixed. All colors. | 1/4 oz. 50c. .15 |

- | No. | | Pkt. |
|------|--|---------------------|
| 8355 | WHITLAVIA grandiflora. Blue flowered, pretty hardy annual, producing throughout the season its bright bell-shaped flowers; adapted to poor soils. 1 ft. | 1/4 oz. 35c. \$0.10 |
| 8360 | grandiflora alba. White. | 1/4 oz. 35c. .10 |
| | WILD CUCUMBER. See <i>Echinocystis</i> . | |
| 8365 | XERANTHEMUM, Double, Mixed. Showy hardy annual of easy culture, giving a profusion of flowers; well suited to drying as everlasting. 1 1/2 to 2 ft. | 1/4 oz. 60c. .15 |
| 8370 | YUCCA filamentosa (Adam's Needle). Fine hardy perennials. The flower spikes are many branched, and the large white, waxy flowers of drooping habit are borne in huge panicles above the sword-shaped foliage during July and August. 4 ft. | 1/4 oz. 75c. .15 |
| 8374 | ZEA japonica Rainbow. Green, white, rose and yellow striped foliage. 5 ft. | Oz. 25c. .10 |
| 8375 | japonica variegata. Beautifully striped green and white foliage. 6 ft. | Oz. 25c. .10 |
| 8380 | gracillima variegata (Miniature Maize). Slender, striped foliage. 3 ft. | Oz. 25c. .10 |
| | ZINNIA. These attractive and decorative hardy annuals are most desirable for borders or bedding purposes, and are remarkable for the profusion and duration of their flowers, which are notable for their large size, fine form, brilliancy and diversity of color; in bloom from June to frost. 1 to 2 ft. | |
| | Double Giant Flowering Columbia Strain. Saved from selected prize flowers. 2 ft. | |
| 8389 | Bright Rose. | 1/4 oz. 50c. .10 |
| 8390 | Cardinal. | 1/4 oz. 50c. .10 |
| 8395 | Crimson. | 1/4 oz. 50c. .10 |
| 8400 | Deep Ruby Red. | 1/4 oz. 50c. .10 |
| 8405 | Flesh Pink. | 1/4 oz. 50c. .10 |
| 8410 | Golden Yellow. | 1/4 oz. 50c. .10 |
| 8415 | Light Canary. | 1/4 oz. 50c. .10 |
| 8420 | Violet. | 1/4 oz. 50c. .10 |
| 8425 | Scarlet. | 1/4 oz. 50c. .10 |
| 8430 | Salmon Rose. | 1/4 oz. 50c. .10 |
| 8435 | White. | 1/4 oz. 50c. .10 |
| 8440 | Columbia Prize Mixture. | 1/4 oz. 50c. .10 |
| 8445 | Collection of 6 colors. Our selection. | .50 |
| 8450 | Dwarf Crimson. 1 ft. | 1/4 oz. 50c. .10 |
| 8455 | Bright Rose. | 1/4 oz. 50c. .10 |
| 8460 | Carmine. | 1/4 oz. 50c. .10 |
| 8465 | Dazzling Scarlet. | 1/4 oz. 50c. .10 |
| 8470 | Flesh Pink. | 1/4 oz. 50c. .10 |
| 8475 | Golden Yellow. | 1/4 oz. 50c. .10 |
| 8480 | White. | 1/4 oz. 50c. .10 |
| 8485 | Mixed. All colors. | 1/4 oz. 50c. .10 |
| 8490 | Collection of 6 colors. Our selection. . | .50 |
| 8495 | Curled and Crested, Mixed. | 1/4 oz. 60c. .15 |
| 8500 | Giant, Mixed. Enormous double flowers in choice colors. 2 ft. | 1/4 oz. 75c. .25 |
| 8501 | Giant Achievement. Very large, semi-cactus-like form. Mixed. | 1/4 oz. 75c. .15 |
| 8502 | Gracillima. Dwarf Red Riding Hood. | .15 |
| 8505 | Lilliput, Mixed. Very small double, fine for borders. 9 in. | 1/4 oz. 50c. .15 |
| 8510 | Crimson Gem. Deep crimson. | 1/4 oz. 50c. .15 |
| 8515 | Golden Gem. Golden yellow. | 1/4 oz. 50c. .15 |
| 8518 | Salmon Rose. | 1/4 oz. 50c. .15 |
| 8520 | Scarlet Gem. Dazzling scarlet. | 1/4 oz. 50c. .15 |
| 8525 | White Gem. Pure white. | 1/4 oz. 50c. .15 |

MIXED FLOWER SEEDS FOR WILD GARDENS

"Wild Gardens" have proved a marked success, and we are in receipt of the most satisfactory evidence of the estimation in which they are held. Anyone who has cultivated flowers knows the constant attention necessary in the care of well laid out beds and borders. To those who cannot give this care, the "Wild Garden" presents a substitute which, for its unusual and varied effects, cheapness, and the small amount of labor necessary for its construction, has no rival. "Wild Garden" seeds are a mixture of over one hundred varieties of flower seeds, and, being mixed together, can be offered at a much less price than when sold in separate packets. The different seasons of bloom insure something new almost every day.

8530 **Dwarf Sorts.** ½ oz. pkts., with full directions..... Each 20c., oz. 40c., 4 ozs. \$1.25, lb. \$3.50
 8535 **Tall Sorts.** ½ oz. pkts., with full directions..... Each 20c., oz. 40c., 4 ozs. \$1.25, lb. \$3.50

GREY'S COLLECTIONS OF FLOWER SEEDS

TEN HARDY ANNUALS, 90c.—1 packet each of the following: Aster American Branching mixed, Balsam Rose-flowered mixed, Calendula Orange King, Centaurea Double Deep Blue, Cosmos Extra Early Mammoth mixed, Delphinium Grey's Imperial mixed, Nasturtium Dwarf Columbia mixed, Petunia Splendid mixed, Scabiosa grandiflora mixed, Zinnia Columbia Prize Mixture.

EIGHT PERENNIALS AND BIENNIALS, 90c.—1 packet each of the following: Canterbury-bells Cup-and-saucer mixed, Coreopsis grandiflora, Delphinium Columbia Hybrids, Digitalis (Foxglove) gloxiniaeflora mixed, Gailardia grandiflora Hybrids, Hollyhock Double Superb mixed, Lupinus polyphyllus mixed, Sweet-william single mixed.

ORNAMENTAL GRASSES

For borders and ornamental gardening; also, when dried, for Winter bouquets and decorations, for which purpose they should be gathered before fully matured.

No.		Pkt.	No.		Pkt.
8540	Finest Mixed. In great variety, for bouquets.	\$0.10	8570	Eulalia japonica zebrina. Beautiful variegated leaves with yellow bars running crosswise; half-hardy perennial. 5 ft.	\$0.10
8545	Avena sterilis (Animated Oats). Annual. 1½ ft.	.10	8575	Gynerium argenteum (Pampas Grass). Large, silvery plume; half hardy perennial. 10 ft.	.10
8550	Arundo donax variegata. Variegated foliage; half-hardy perennial. 7 ft.	.10	8580	Hordeum jubatum (Squirrel's Tail). Annual. 2 ft.	Oz. 50c. .10
8555	Briza maxima (Quaking Grass). Annual. 1 ft.	.10	8585	Lagurus ovatus (Hare's Tail). Annual. 1 ft.	.10
8560	Bromus brizaeformis. Drooping; annual. 1½ ft.	.10	8590	Pennisetum rupellianum. Beautiful crimson-purple plumes, from Spring-sown seed. ¼ oz.	60c. .15
8565	Coix lachryma (Job's Tears). Striped leaves; annual. 2 ft	.10	8595	Stipa pennata (Feather Grass). ¼ oz.	2 ft. \$1.50 .15



PALMS, FERNS AND DECORATIVE PLANTS

Unless otherwise directed, we ship all this class of plants by express, as we consider it much more safe, and the principal express companies charge 20 per cent less than their regular merchandise rates on plants packed in covered boxes or crates.



Kentia

ALLAMANDA hendersoni. A strong growing greenhouse climber producing numerous, large golden yellow flowers; suitable for covering a trellis or the supports of a conservatory. 75c. and \$1.25 each.

ARALIA. Handsome foliage plants for conservatory decoration.

elegantissima. \$1.50 and \$2.25 each.

veitchi. Dark green, narrow leaflets, red underneath. \$1.25 and \$2.00 each.

veitchi gracillima. Very graceful foliage. \$2.25 and \$2.75 each.

ASPARAGUS plumosus nanus (Asparagus Fern). Bright green, delicate foliage. 25c. and 35c. each; \$2.50 and \$3.50 per doz.

sprengeri. Excellent for the window box, hanging baskets and for cutting. 20c. and 30c. each; \$2.00 and \$3.00 per doz.

ASPIDISTRA. A decorative plant well suited for shady nooks and places away from the light; will succeed where other plants fail.

lurida. Long green leaves. \$2.25 to \$5.00 each.

lurida variegata. Green and white striped foliage. \$2.25 to \$3.50 each.

BEGONIA, Gloire de Melior and Gloire de Cincinnati.

Two varieties of Winter blooming Begonias of same habit as the old Gloire de Lorraine but larger leaved and more brilliant color. 2¼ in. pots, \$6.00 per doz.; 3½ in. pots, \$10.00 per doz.

Rex. Beautiful ornamental foliage. 50c. to \$2.50 each.

CROTONS. Beautiful and rich colored foliage, for conservatory decoration, exhibition and bedding. Leading varieties. \$1.00 to \$5.00 each.

CYPERUS alternifolius (Umbrella Plant). Fine for house culture when liberally supplied with water. 25c. and 75c. each.

DRACAENAS. Excellent decorative plants for house and conservatory.

fragrans. Broad, dark green foliage. 50c. to \$1.50 each.

godseffiana. Rich, dark green, with creamy white spots. 50c. to \$1.50 each.

indivisa. Long, narrow foliage used in vases, etc. 50c. to \$1.00 each.

lindeni. Broad, green foliage, with golden yellow stripes on the edges. \$2.00 to \$4.00 each.

massangeana. Like preceding, with stripe through the center of leaf. 75c. to \$2.00 each.

terminalis. Rich red foliage, marked with pink and white. \$1.00 and \$3.00 each.

FERNS. We have an immense quantity of nice, bushy plants in fine varieties for filling dishes. \$1.75 per doz., \$10.00 per 100.

Adiantum. In leading sorts. 2¼ in. pots, \$2.00 per doz.; 3 in. pots, \$3.00 per doz.; 4 in. pots, 75c. each.

Pteris. In best varieties. 2¼ in. pots, \$1.50 per doz., \$10.00 per 100; 3 in. pots, \$2.50 per doz., \$12.00 per 100; 4 in. pots, 50c. each.

Nephrolepis (Sword Fern). In following varieties: **Bostoniensis, piersoni, scotti, whitmani.** 50c. to \$5.00 each.

FICUS (Rubber Plant). Extensively used in house decoration.

elastica. The common Rubber Plant. 75c. to \$2.50 each.

pandurata. New, with beautiful foliage. \$1.50 to \$3.00 each.

MARANTA. Fine decorative plants, with beautiful variegated foliage.

Various Sorts. 75c. to \$1.00 each.

We can supply many other varieties of greenhouse plants not listed in this catalog. Prices on request.

PALMS

ARECA lutescens. A very graceful and beautiful Palm. Foliage glossy green with yellow stems. 3 in. pots, 50c. each; 4 in. pots, 75c. each; 5 in. pots, \$1.50 to \$2.00 each.

KENTIAS belmoreana and forsteriana. These are considered the hardiest Palms and best adapted to house culture. The foliage is rich dark green and of spreading habit. 4 in. pots, \$1.00 each; 5 in. pots, \$2.00 each; 6 in. pots, \$5.00 each; 7 in. pots, \$7.50 each; 8 in. pots, \$15.00 to \$20.00 each.

COCOS weddelliana. The most elegant and graceful of all the Palms, the smaller sizes being excellent for fern dishes. 2¼ in. pots, 50c. each; 3 in. pots, 75c. each; 6 in. pots, \$2.25 and \$2.75 each.

PHOENIX canariensis (Date Palm). Dark green feathery foliage. 10 in. tubs, \$15.00 each.

roebelini. Most graceful variety. 8 and 10 in. pots, \$8.00 and \$12.00 each.

SUMMER-FLOWERING BULBS AND TUBEROUS ROOTS

Gladiolus

For general garden decoration and for cut flowers the Gladiolus is deserving of special attention. Very effective for massing in large beds where a brilliant effect is desired. Of easiest culture, seldom disappointing and immune from insect pests. They thrive in well prepared enriched loam planted 3 inches deep and 6 inches apart. Frequent watering very beneficial.

We respectfully call your attention to the several new varieties listed for the first time this year, many of them Kunderd's and Diener's finest originations. Six bulbs offered at the dozen rate.

	Doz.	100		Doz.	100
Columbia Prize Mixture. The most satisfactory mixture to grow, being selected from collections of the best hybridizers and growers of both continents with a view of eliminating all colors which do not harmonize either in cut flower or garden planting....					
1000, \$60.00	\$0.85	\$6.50			
Home Garden Mixture. A superior strain unlimited as to size, color and markings.					
1000, \$32.00	.50	3.50			
Aida. A striking dark blue, with small, reddish throat blotches. Extremely early....	2.50	18.00			
America. Soft lavender pink; one of the finest ever sent out.....	1000, \$32.00	.50	3.50		
Annie Laurie. White, flushed pink, semi-ruffled, the ruffling of a very fresh carmine pink.....	1.00	7.50			
Baron Hulot. Deep violet-blue, one of the finest.....	\$1.00	\$7.50			
Berty Snow. Large florets of beautiful clear lavender. Tall, straight spike and strong habit.....	2.00	15.00			
Break o'Day. A clear light pink. In habit and growth very similar to Halley.....	.70	5.00			
Carmen Sylva. A pure white except for slight violet markings in throat. One of the best whites.....	.80	6.00			
Crimson Glow. Deep crimson, lighter in throat. Exhibition variety.....	.60	4.50			
Dr. F. E. Bennett. A very large fiery red. Considered Diener's best red.....	.80	6.00			
Elizabeth Tabor. This variety known as the earliest to bloom is a very high class introduction. Delicate rosy pink on white ground, rich dark crimson spot on lower petals....	.70	5.00			
E. I. Farrington. A very beautiful rich self yellow. Many florets of fair size open at one time. One of the most popular yellows....	2.50	18.00			
Fern Kyle. Kunderd's massive creamy white exhibition variety.....	.80	6.00			
Giant Nymph. A giant in growth and flowers. Light rose-pink with creamy yellow throat..	.80	6.00			
Gloriana. A very fine large salmon, with yellow throat. No other markings.....	.70	5.00			
Golden Frills. Deep rich daffodil yellow, frilled edges. Light red line lower petals...	.70	5.00			
Halley. Very large, lovely salmon-pink; the lower petals have yellow blotch with carmine markings.....	.60	4.50			
Herada. A large, tall variety of a pure glistering mauve.....	.60	4.50			
Jenny Lind. A more refined or beautiful variety could not be desired. Its soft apricot-pink, pale yellow throat are colors which blend well together.....	1.10	8.00			
Joerg's White. Very large, wide open flowers of pure white with slight crimson markings over yellow throat.....	1.75	12.00			
Longfellow. Considered the best pink. A tall grower with large open flowers, perfectly placed.....	1.10	8.00			

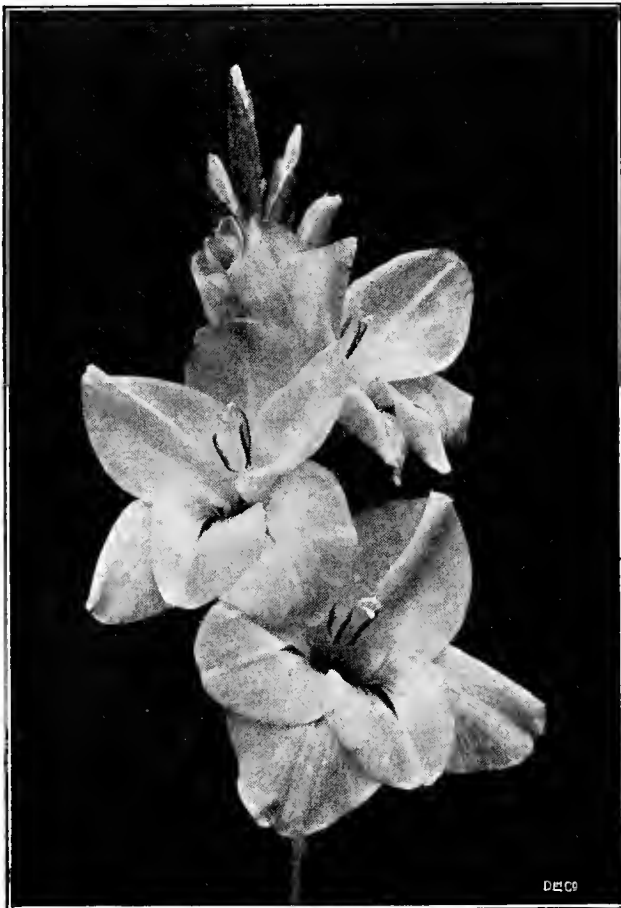

Gladiolus Louise (See page 65)

GLADIOLUS—Continued Doz. 100

Louise. A very popular lavender and not high in price. The blooms are bright lavender with wine-colored blotch in throat. A variety which should be in everybody's garden.....	\$0.80	\$6.00
Marietta. A delicate shade of light salmon, blended with light orange. Lower petals shading to a bright burnt orange. A marvelous gladiolus	1.20	8.50
Marmora. Lavender gray color, with petunia colored blotch. A fine exhibition variety..	1.50	10.00
Marshal Foch. Kunderd's beautiful salmon pink. Beautifully ruffled and strong grower.	.80	6.00
Mary Pickford. Delicate creamy white, throat sulphur-yellow. One of the best....	.70	5.00
Minuet. New self colored lavender; rich, very large flower of heavy substance.....	1.50	10.00
Mrs. Dr. Norton. A pure white, with tips of petals La France pink. Finest variety of this type.....	.70	5.00
Mrs. F. C. Peters. Beautiful shade of rosy-lilac, crimson blotched, bordered white on lower segment.....	.80	6.00
Mrs. Frank Pendleton. Fine large salmon-pink, with blood-red blotch at throat....	.70	5.00
Mrs. Francis King. Immense flowers of a flame-pink or light scarlet.....	.70	5.00
Mrs. Leon Douglass. One of the largest, showiest and most vigorous in existence. Color is rose, striped with brilliant scarlet, pale lemon lip.....	.70	5.00
Mrs. Van Konynenburg. Aniline blue of strong growth. A trifle darker than Heavenly Blue.....	1.50	10.00
Peace. Pure white with delicate lilac feathering, strong grower.....	.70	5.00
Pearl of California. Flower is of the clearest softest La France pink, blending to a rosy white throat with 8 to 12 open at a time...	2.00	15.00
Persia. Darkest variety known. The color is deep red of the mahogany tone, so dark as to appear almost black. Always creates interest wherever shown.....	1.00	7.00
Pfitzer's Triumph. A giant orange salmon, blotched red on lower petals. An outstanding variety.....	1.50	10.00
Primrose Princess. This is without doubt the best new yellow. Large, clear, light yellow. An exhibition novelty.....	1.75	12.00
Richard Diener (New). This variety has 10 to 12 blooms well placed, open at one time. Very live rose-salmon, with creamy yellow center. Considered the finest variety of its color.....	1.10	8.00
Saraband. Unusual color, rich velvety Bordeaux with yellow blotch.....	1.50	10.00
Schwaben. Soft pure yellow with small dark spot in throat. Extra.....	.80	6.00
Sunnymede. Rare shade of orange yellow. Extra fine spike with many well placed blooms open at a time.....	1.00	7.00
Veilchenblau. The best of all the newer blue varieties. Violet blue flower of fine form and habit.....	1.75	12.00
W. H. Phipps. Beautiful flesh pink with about twenty-two blooms to a spike and nearly all opening at a time.....	1.10	8.50



Gladiolus, Columbia Prize Mixture (See page 64)

Primulinus Varieties

The following list of Primulinus we highly recommend. The colors which are mostly yellows, oranges, pinks, etc. are especially desirable as cut flowers for vase work.

	Doz.	100
Ada de Poy. Very beautiful, new Primulinus hybrid of clear apricot with bronze shadings. Slightly ruffled. Elegant exhibition variety.	\$1.00	\$7.00
Alice Tiplady. A soft burnt orange. The queen of the Primulinus type.....	.60	4.00
Apricot Glow. One of the finest of the Primis. Beautiful warm buff, edged soft apricot.....	1.10	8.00
Ethelyn. One of the best primulinus varieties. A beautiful shade of orange yellow, petals tipped with bronze.....	.80	6.00
Ming Toy. One of the finest of the Primis. Tall, beautiful buff, yellow center.....	.60	5.00
Shell Pink. Beautiful shell pink, almost self color.....	.80	6.00
White Butterfly (New). Beautiful Kunderd variety. Pure white, Butterfly form.....	1.00	7.50
Mixture. Containing a fine collection of popular named varieties.....	.50	3.50

GLADIOLUS

By F. F. Rockwell

We highly recommend this book to anyone interested in this popular flower.

\$1.00 per copy

LILIES

In the flower garden Lilies rank first in importance. They are stately and beautiful, matchless in form and variety of color, while possessing the most agreeable perfume, and for general effect they have no rivals. Bulbs should be planted 6 inches deep in a well drained, deep, loamy soil made rich with thoroughly rotted manure, and an inch of clean sand placed under and over the bulbs when setting. Each Doz. 100

- Auratum** (Golden-rayed Lily of Japan). Large, pure white flowers, with crimson spots and a golden band through the center of each petal. 2 to 4 ft. high, blooming from July to October. Large bulbs.....\$0.25 \$2.75 \$20.00
Mammoth bulbs..... .40 4.00 30.00
- Canadense flavum.** Bright yellow spotted with black. 2 to 3 ft. June and July..... .25 2.50 20.00
- Henryi** (Yellow Speciosum). Beautiful Lily from China. Rich apricot yellow, reddish brown spots. 5 ft. July and Aug..... .50 5.00



Lilium speciosum rubrum or *roseum*

- Speciosum album.** Large, fragrant, pure white. Mammoth bulbs..... .65 6.50 50.00
- Speciosum magnificum.** Rich red, heavily spotted; much larger and richer colored than the other varieties. Large bulbs..... .25 2.75 20.00
Mammoth bulbs..... .60 5.00 35.00
- Speciosum melpomene.** White, shaded with rich blood crimson; heavily spotted. Large bulbs..... .25 2.75 20.00
Mammoth Bulbs..... .60 5.00 35.00
- Speciosum rubrum, or roseum.** White, shaded and spotted rosy crimson; fragrant. Large bulbs..... .25 2.75 20.00
Mammoth bulbs..... .60 5.00 35.00

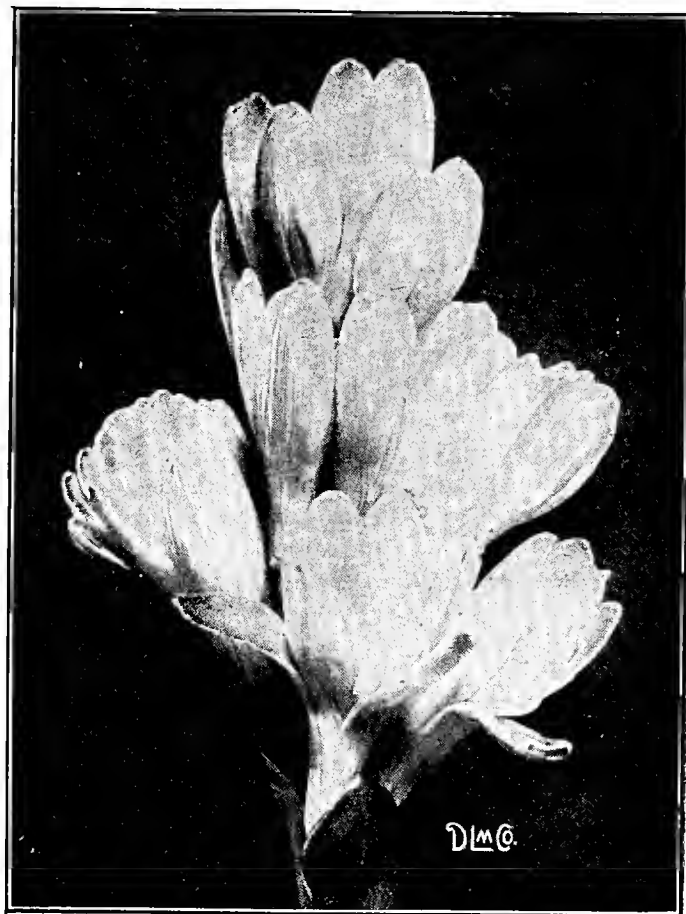

Tuberosa (See page 67)

- Superbum** (Native Turks-cap). Rich orange, petals tipped with red, and spotted. 4 to 6 ft. July.....\$0.25 \$2.50 \$20.00
- Tigrinum splendens** (Tiger Lily). Orange salmon, spotted; the finest form. Mammoth bulbs..... .30 2.75 20.00

LILY-OF-THE-VALLEY (Convallaria)

Grey's Perfect Forcing Pips. The finest grade of pips that come to this country and especially selected for our large, private trade, which demands only the best for forcing throughout the year. *We carry these in cold storage and can furnish them at any time.* Three to four weeks are usually allowed for forcing cold storage pips into flower. Per case of 250, \$15.00.



Lily-of-the-valley

ACHIMENES

One of the finest Summer blooming plants for house or conservatory, giving handsome flowers of many shades and colors.

Finest Mixed Varieties. Doz. \$2.00, 100 \$15.00.

Orchida. A lovely orchid pink color. Large flowers. Doz. \$2.75, 100 \$20.00.

Galatea. Large, deep lavender.

Magnifica. Beautiful violet blue.

Purity. Large, pure white.

Purple King. A good rich purple.

Supreme. Lavender with light center.

25c. each, 3 corms for 50c., \$2.00 per doz.

ACIDANTHERA

Bicolor. A Summer flowering bulb, having beautiful, creamy white fragrant flowers with a purple maroon blotch at base of petals. Doz. \$2.00, 100 \$15.00.

BEGONIAS

Splendid pot plants for the house or greenhouse, and especially valuable for bedding, flowering in the greatest profusion throughout the Summer. For bedding they should be started in hotbed in March and April.

SINGLE TUBEROUS ROOTED

Separate Colors. Crimson, pink, white, yellow, salmon, scarlet. Each 25c., doz. \$2.75, 100 \$20.00.

DOUBLE TUBEROUS ROOTED

Separate Colors. Crimson, pink, white, yellow, salmon, scarlet. Each 25c., doz. \$2.75, 100 \$20.00.

Friiled or Crested. Mixed colors. Each 25c., doz. \$2.50.

CANNAS, Dormant Roots

A class of plants for grand effects. Their rich and vari-colored leaves, combined with large and beautiful flowers of brilliant colors, make them very desirable for planting in groups on the lawn, or singly in beds. Keep the roots in a warm, dry place through the Winter.

Robusta. Very dark foliage; robust grower, 6 to 8 ft. Each 12c., doz. \$1.25.

Large-flowering French Mixed. Finest varieties. Each 12c., doz. \$1.25.

DAHLIAS

Special Dahlia Catalog mailed on application

We are agents for one of the largest and best growers of Dahlias in the East. A descriptive catalog with prices of all new and up-to-date sorts, as well as older varieties, with directions for culture and treatment, will be mailed to all our customers who apply.

GLOXINIAS, Large Flowered

Delivered January

Magnificent for house or conservatory, producing in great profusion flowers of the richest and most beautiful colors. They succeed best in sandy loam and peat, and require a moist heat.

Mixed Colors. Doz. \$5.00, 100 \$40.00.

HYACINTHUS CANDICANS

A magnificent species, with flower stems 3 feet high, bearing large, pure white flowers in July and August. It is perfectly hardy. Extra large bulbs. Doz. \$1.10, 100 \$8.00.



Montbretias

MONTBRETIAS

One of the best and brightest Summer-flowering bulbs sure of becoming firm favorites wherever grown. Planted in clumps from April to June they produce numerous graceful spikes of brilliant star-shaped flowers. Hardy with protection.

Crocosmaeflora. Searlet and yellow. Doz. 65c., 100 \$4.00.

George Davison. Large orange yellow. Doz. \$1.00, 100 \$7.00.

Fire King. Large, glowing searlet red. One of the best new reds. Doz. \$1.10, 100 \$8.00.

California. Deep golden yellow. Doz. 70c., 100 \$5.00.

Hereward. Late, large flowering, yellow, shaded orange on the outside. Doz. \$1.50, 100 \$10.00.

His Majesty. A vigorous new seedling with handsome foliage. Outside bright red, inside searlet with yellow center. Doz. \$3.50, 100 \$25.00.

Sunset. Nearly pure orange. An attractive shade, good spike and bronze colored foliage. Doz. \$1.20, 100 \$8.00.

Splendid Mixture. A well blended mixture of colors. Doz. 60c., 100 \$4.00.

TUBEROSES

A bulbous plant of the easiest culture and most delightful fragrance, suitable for the Summer garden or house culture throughout the year. They should be started early in pots, using good, rich, loamy soil, and when the weather is suitable, transplanted into the garden. The variety offered is the one most extensively grown, being much superior to all other sorts.

Excelsior Pearl. A superior strain, with very large, double white flowers, produced in great abundance. Extra large bulbs. \$1.25 per doz., \$9.00 per 100.



Antirrhinum (Snapdragon)

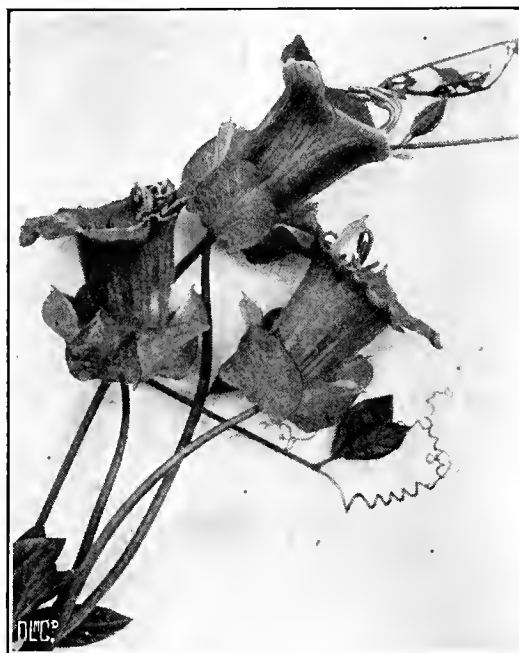

Cobaea scandens



Geranium

Foliage and Flowering Plants

FOR SUMMER BEDDING

	Doz.	100		Doz.	100
Abutilon	\$2.50	\$19.00	Daisy, Paris White. Single white.....	\$3.00	\$23.00
Alternanthera. Dwarf scarlet.....	1.25	8.50	Feverfew, Double White	1.75	12.50
Alternanthera. Dwarf yellow.....	1.25	8.50	Feverfew, Golden Feather	1.25	8.50
Achyranthes. Bright crimson.....	1.50	10.00	Fuchsias. In variety.....	3.00	23.00
Achyranthes. Green and white.....	1.50	10.00	Geranium, Double Varieties	3.00	23.00
Ageratum. Blue or white.....	1.75	12.50	Geranium, Single Varieties	3.00	23.00
Alyssum, Double White	1.25	8.50	Geranium, Ivy-leaved Sorts	3.00	23.00
Alyssum, Single White	1.00	7.50	Heliotrope, Giant Elsa	2.75	22.00
Antirrhinum (Snapdragon). Assorted.....	1.75	12.50	Heliotropes. Dark and light.....	2.25	17.00
Asters. Assorted colors. Double.....	.50	3.50	Lantanas. In variety.....	2.00	15.00
Asters. Double white.....	.50	3.50	Lobelia. Dark blue, for bedding.....	1.25	8.50
Begonia. Tuberous-rooted mixed.....	4.00	30.00	Marigold, Dwarf French	1.25	8.50
Begonias. In variety.....	2.50	18.00	Mignonette, Large-flowered	1.00	7.50
Caladium esculentum	3.00	23.00	Nicotiana affinis. White, fragrant.....	1.25	8.50
Calendula, Orange King	1.50	10.00	Nicotiana sanderae. Carmine.....	1.25	8.50
Cannas, Dwarf Large-flowering French ...	2.00	15.00	Pansy. Special strain, extra choice.....	.70	5.00
Cannas. In the following varieties: Ambas-			Petunia, Double. Assorted colors.....	2.25	17.00
sador, City of Portland, King Humbert,			Petunia, Single. Assorted colors.....	1.25	8.50
Yellow King Humbert, King Midas,			Phlox drummondii. Assorted.....	1.25	8.50
Mrs. Alfred Conard, The President,			Ricinus (Castor-oil Bean).....	1.75	12.50
Hungaria	2.25	17.00	Salpiglossis. Mixed colors.....	1.50	10.00
Centaurea candidissima	1.50	10.00	Salvia splendens. Best scarlet.....	1.75	12.50
Centaurea gymnocarpa	1.50	10.00	Torenia fournieri. Blue.....	1.50	10.00
Chrysanthemums. Our collection of these			Verbenas. Assorted colors.....	1.25	8.50
beautiful Fall blooming plants embraces			Verbena. Lemon-scented.....	3.00	23.00
the best of the old and newer introductions.	2.50	Vinca alba and rosea (Flowering Vinca)....	1.25	8.50
Cobaea scandens	2.25	17.00	Vinca variegata (Periwinkle). Trailing....	2.50	19.00
Coleus. Fine varieties.....	1.25	8.50	Wallflower, Mixed	1.75	12.50
Cosmos. Early flowering.....	1.00	7.50	Zinnia, Columbia Prize. Assorted.....	1.00	7.50
Daisy, Double English. Assorted.....	.85	6.00			
Daisy, Paris Golden. Single yellow.....	3.00	23.00			

Many other varieties not mentioned in this list can be furnished at regular prices

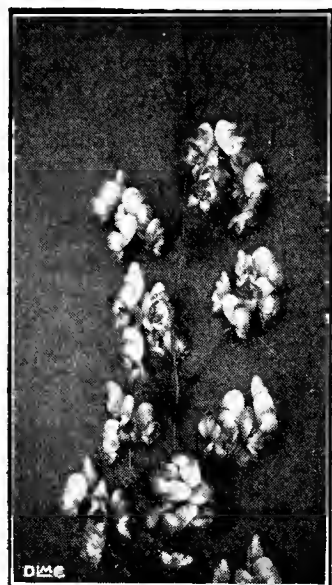

Aconitum



Anemone



Hardy Asters

Select List of Hardy Perennial Plants

We can furnish a good selection of hardy plants, which may be expected to give successional bloom throughout the Spring, Summer and Fall months, and, if the choice is left to us, will take special care to select such varieties as afford the most satisfactory results.

We also furnish estimates on the laying out, planting and improvement of private estates, and furnish experienced gardeners to carry out the work. We shall be pleased to correspond with those contemplating improvements or planting hardy stock of any sort.

PARCEL POST—Add six cents for one plant, two cents for each additional plant.

ACHILLEA (Milfoil or Yarrow).	Each	Doz.		AQUILEGIA (Columbine).	Each	Doz.
Perry White. 20 in. New variety, June to Sept.....	\$0.25	\$2.50		Long-spurred Hybrids. 2 ft. These embrace all the colors of the long-spurred type. May to July.....	\$0.25	\$2.50
ptarmica fl. pl. var., The Pearl. Double white flowers, most useful for cutting. June to Oct.....	.25	2.50		formosa truncata. 1 to 2 ft. Large yellow flowers with scarlet sepals.....	.25	2.50
ACONITUM napellus (Monkshood). Dark blue flowers from July to Sept. 3 ft....	.40	4.00		chrysantha (Golden). 2 to 3 ft. Yellow long-spurred flowers. May to Aug....	.25	2.50
fischeri. A dwarf variety with pale blue flowers. Sept. 18 in.....	.40	4.00		caerulea (Rocky Mountain Blue Columbine). 2 ft. Long spurs, blue and white flowers. May to July.....	.25	2.50
AGROSTEMMA (Rose Campion). Excellent and showy plants for borders.				ARABIS alpina (Rock Cross). 6 in. Early white Spring-flowering plants. Fine for rock work and borders. April to June..	.25	2.50
coronaria. 2 ft. Single rosy crimson flowers. June to Aug.....	.25	2.50		ARMERIA maritima (Sea Pink or Thrift). 1 ft. A fine plant for rockeries or edgings; flowers bright pink.....	.25	2.50
AJUGA reptans (Bugle Plant). 6 in. Blue. Excellent for rock work, covering banks and shady places. May.....	.25	2.50		ASCLEPIAS tuberosa (Butterfly weed). One of the showiest of our native flowers; brilliant orange. June to July.....	.25	2.50
ALYSSUM saxatile compactum (Basket of Gold). 1 ft. A grand plant for the rockery or border. April to June.....	.25	2.50		ASTER (Michaelmas Daisies). These are our most showy Fall flowers.		
ANCHUSA italica, Dropmore Variety. 3 to 4 ft. A lovely shade of gentian blue, and blooms the entire season.....	.25	2.50		25c. each, \$2.50 per doz.		
ANEMONE japonica rubra (Windflower). 2 to 3 ft. Flowers of medium size, color rose; stamens yellow. Sept. to Nov....	.25	2.50		Amos Perry. 3 ft. Large deep pink. Sept.		
japonica alba. 2 to 3 ft. Flowers large, white. One of the best. Sept. to Nov....	.25	2.50		Beauty of Colwell. 4 ft. Double lavender. Aug. to Sept.		
japonica, Queen Charlotte. 2 ft. Large, semi-double, silvery pink. Sept.....	.25	2.50		Climax. 5 ft. Light bluish lavender. Aug. to Oct.		
japonica, Whirlwind. 2 to 3 ft. Large, semi-double, pure white. Sept.....	.25	2.50		Elta. 3-4 ft. New, double flowers of pale lilac. Oct.		
ANTHEMIS tinctoria (Golden Marguerite). 2 to 3 ft. Lemon-yellow. June to Oct....	.25	2.50		Joan Vaughan. 2½ ft. Semi-double, blue.		
				Lady Lloyd. 3-4 ft. Rose-pink. Aug.-Sept.		
				Mrs. Raynor. 4 ft. Deepest red of all Asters. Sept.-Oct.		
				Peggy Ballard. 3 ft. Large pyramidal sprays of double rosy mauve flowers.		
				St. Edgwin. 2½ ft. Bright pink. Sept.-Oct.		



Larkspur



Centaurea

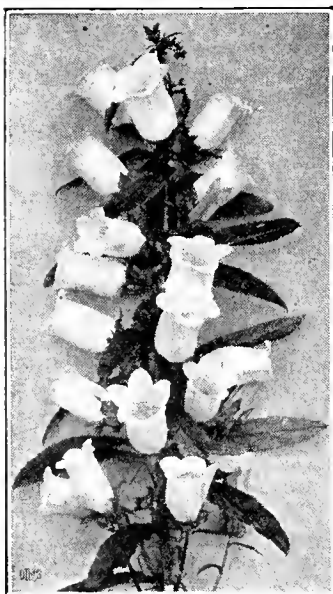

Canterbury-bells



Pompon Chrysanthemums



Sweet-william

- BAPTISIA australis** (False Indigo). 2 ft. Long racemes of dark blue flowers. June to July..... Each Doz. \$0.25 \$2.50
- BOCCONIA cordata** (Plume Poppy). 5 to 8 ft. White flowers with fig leaf foliage; very effective. July, Aug..... .25 2.50
- BOLTONIA asteroides** (False Chamomile). 5 to 6 ft. Fine late-flowering perennials. Aster-like white flowers. Aug. to Sept..... .25 2.50
- latisquama**. 4 ft. Flowers clear lavender; fine for cutting..... .25 2.50
- CAMPANULA carpatica** (Harebell). 9 in. Erest blue flowers, useful for edgings. June to Sept..... .25 2.50
- carpatica alba**. 9 in. Pure white..... .25 2.50
- medium** (Canterbury-bells). 3 ft. Biennial. Flowers blue, white and rose. Separate colors. June, July..... .25 2.50
- medium calycanthema** (Cup-and-saucer). Biennial. Separate colors.. .25 2.50
- persicifolia**. Peach-leaved. 2 ft. Blue. June to Aug..... .25 2.50
- persicifolia alba**. 2 ft. White. June to Aug..... .25 2.50
- pyramidalis** (Chimney Bell Flower). 4 ft. Blue. July to Sept..... .25 2.50
- rotundifolia** (Blue Bells). 1 ft. Blue. June to Aug..... .25 2.50
- CENTAUREA montana**. 20 in. Large purple flowers. Fine for cutting. June..... .25 2.50
- CERASTIUM tomentosum** (Snow-in-summer). 5; to 6 in. Low growing plant. Silvery foliage, white flowers; fine for rockeries..... .25 2.50
- CHELONE lyoni** (Turtlehead). 2 ft. Showy deep red flowers, bearing Snapdragon-like blooms and spikes. Aug. to Sept..... .25 2.50
- CHRYSANTHEMUMS, Hardy**. Flowering very freely in the Autumn, excellent for cutting and one of the last to be cut down by frost. Sept. to Nov. The following sorts (1½ to 3 ft.): Each 25c., doz. \$2.50
- Brown Bessie**. Pompon. Reddish bronze. **Marie Antoinette**. Rose pink. **Carrie**. Light yellow. **Mrs. F. Collier**. Small white. **Etoile d'Or**. Bright yellow. Large. **Niza**. Deep pink Pompon. **Excelsior**. Bright golden yellow. **Normandie**. White, tinted blush-pink. **Glory of Seven Oaks**. Golden yellow. **Oconto**. Japanese. Large white. **Golden Queen**. Bright yellow. **Old Homestead**. Large pink. **L'Argentuillais**. Deep chestnut. **Skibo**. Golden yellow. Pompon. **Model**. Light yellow Pompon. **Well's Scarlet**. Terra cotta red.
- CHRYSANTHEMUM, Burbank's Shasta Daisy**. 1½ ft. Large snow-white flowers; blooms all Summer..... .25 2.50
- COREOPSIS**. One of the best blooming all-Summer plants we have. **lanceolata grandiflora**. 2 ft. Large golden yellow..... .25 2.50
- DELPHINIUM** (Larkspur). **belladonna**. 3 ft. Sky blue..... .25 2.50 **bellamosum**. 3 ft. Dark blue..... .25 2.50 **chinensis**. 2 ft. Gentian blue. Blooms all Summer..... .25 2.50 **chinensis album**. 2 ft. Blooms all Summer..... .25 2.50 **Hollyhock Strain** (Wrexham). A new giant race, double and semi-double. Many new and lovely shades. Mixed..... .85 9.00
- DIANTHUS plumarius** (Garden Pinks). A valuable and showy border plant; single and double. Very fragrant. May to Aug. **barbatus** (Sweet-william). 1 to 1½ ft. Mixed vars. June and July. .25 2.50 **deltoides** (Maiden Pink). A dwarf trailer with rosy-pink flowers. June to Aug..... .25 2.50
- DICENTRA, or Dielytra** (Bleedingheart). **spectabilis**. 2 ft. An old-fashioned favorite. May and June..... .50 5.00
- DICTAMNUS fraxinella** (Gas Plant). 2½ ft. Rosy crimson, fragrant foliage. May to July..... .35 3.50
- DIGITALIS** (Foxglove). The flower heads are over 3 ft. long, crowded with big, bell-shaped blossoms. Colors range from white and shell-pink to deepest rose..... .25 2.50

ECHINOPS ritro (Globe Thistle). Showy Each Doz.
thistle-like plants with metallic-blue globular flowers. 3 ft. July to Sept. \$0.25 \$2.50

ERYNGIUM amethystinum (Seaholly). 2½ ft. Lovely amethyst blue flowers and finely cut spiny foliage; June to Sept.25 2.50

FUNKIA (Plantain-lily). A beautiful class of plants growing well in partial shade.

subcordata grandiflora (White Day-lily). 2 ft. A pure white trumpet flowered and fragrant species. July to Sept.35 3.50

undulata variegata. 1 ft. Beautiful variegated foliage, flowers lilac.25 2.50

GAILLARDIA grandiflora (Blanket flower). 2 ft. Large crimson and gold; good for cutting. June to Nov.25 2.50

GYPSOPHILA paniculata (Babysbreath). 2 ft. An old-fashioned favorite; very useful, pure white flowers. June to Aug.25 2.50

HELENIUM autumnale rubrum. 5 ft. Reddish-brown, Aster-shaped flowers; profuse bloomer. Aug. to Oct.25 2.50

autumnale superbum. 5 ft. Immense heads of golden yellow flowers. Aug. to Oct. .25 2.50

Riverton Gem. Old gold suffused with terra cotta. Aug. to Oct.25 2.50

HELIANTHUS (Sunflower). These form a very important group of bold, showy Autumn flowering plants.

maximiliani. The latest of all. Golden yellow flowers in graceful sprays in Oct. Fine for cutting. 6 ft.25 2.50

multiflorus fl. pl. 4 ft. Deep yellow double Dahlia-like flowers. July to Oct. .25 2.50

HELIOPSIS pitcheriana (Ox-eye). 3 ft. Very desirable, blooming all through the Summer. Deep orange yellow.25 2.50

HEMEROCALLIS (Day-lily). Does well in partial shade and moist places.

Apricot. Fine orange yellow, large and free flowering, June and July. 2½ ft.25 2.50

flava. 3 ft. Golden yellow. May and June. .25 2.50

thunbergi. Very fragrant flowers lemon-yellow, blooms in late Spring.25 2.50

HEUCHERA sanguinea. 1½ ft. Graceful Each Doz.
spikes of delicate coral-red flowers. June and July. \$0.25 \$2.50

HIBISCUS, Crimson Eye (Mallow). 4 ft. Large, pure white, with crimson spot in center. July and Aug.25 2.50

moscheutos roseus. 4 ft. Pink. July and Aug.25 2.50

moscheutos albus. 4 ft. White. July and Aug. .25 2.50

HOLLYHOCKS. Finest double variety. Separate colors or mixed.25 2.50

Finest Single Varieties.25 2.50

IBERIS sempervirens (Candytuft). 1 ft. Evergreen foliage; good for borders. May and June.25 2.50

IRIS germanica (Garden Iris). They form a group unparalleled in beauty. Every shade of color may be found among them, and they will thrive in almost any soil or situation.

25c. each, \$2.50 per doz., \$18.00 per 100

Caprice. Chinese violet.

Fairy. White suffused blue.

Florentine alba. Large fragrant white flowers.

James Boyd. Blue and violet.

Japanesque. Lavender and white.

Khediye. Soft lavender, orange beard.

Kochi. Dark purple.

Lohengrin. Cattleya rose.

Lorelei. Falls marine-blue veined with white and bordered with yellow.

Madam Chereau. White, feathered edges of sky blue; free flowering.

Mandaliscae. Lavender purple.

Monsignor. Deep purplish blue.

Mrs. Allen Gray. Rose mauve.

Mrs. H. Darwin. White and lavender.

Nibelungen. Fawn yellow, falls blue.

Pocohontas. White, penciled lavender, nearly double.

Powhatan. Violet purple.

Rose Unique. Early pink.

Rhine Nixe. White and blue.

Sans Souci. Golden yellow.

Seminole. Violet rose and crimson.

Sea Gull. Blue and white.



Coreopsis

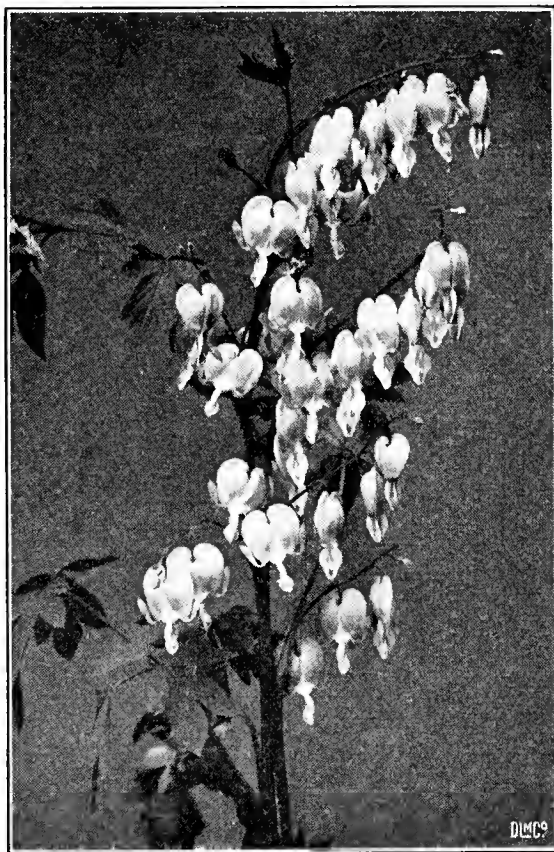

Dicentra spectabilis (Bleedingheart)

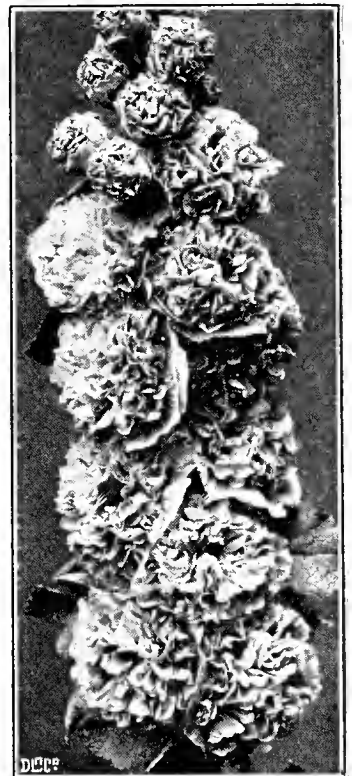

Hollyhock

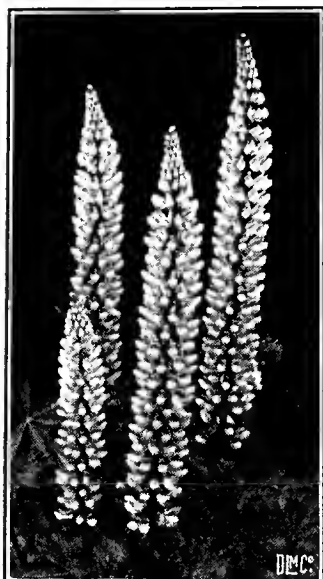

Lupine

IRIS, Japanese (Iris Kaempferi)

45c. each, \$4.50 per dozen. Double, except where noted.

- Astarte.** Dark violet.
- Gekka-No-Nami.** Creamy white.
- Gold Bound.** White; yellow markings.
- Hano No Mio.** Mahogany red.
- Helen-Van-Seibolt.** Red-veined white.
- Isso-No-Nami.** Rosy lilac, rose center.
- Mahogany.** Mahogany red.
- Neptune.** Single, mahogany red.
- Norma.** Deep purple.
- Oniga-Shima.** Violet-purple, golden center.
- Purple and Gold.** Violet purple.
- Seco-No-Nami.** Single, reddish purple, and white.
- Vase-Banri.** White, veined blue.
- Yedo-Jaman.** Royal blue.

- LATHYRUS latifolius (Everlasting Pea).** 5 ft. Flowers large, bright red. Each Doz. July to August..... \$0.25 \$2.50
- LAVANDULA vera.** True lavender. 2 ft. Fragrant bluish flowers; foliage gray, with fragrance of lavender..... .25 2.50
- LIATRIS pycnostachya (Blazing Star).** 4 ft. Showy spikes of rosy-purple flowers. July to September..... .25 2.50
- LILY-OF-THE-VALLEY.** Strong clumps..... .50 5.00
- LINUM perenne.** 18. in. Light blue flowers, which are produced all Summer. .25 2.50
- LOBELIA cardinalis (Cardinal flower).** 3 ft. Cardinal-red. Aug. to Oct... .25 2.50
- LYCHNIS chalconica (London Pride).** 3 ft. Brilliant heads of crimson flowers. June to Sept..... .25 2.50
- viscaria.** 1½ ft. Single, scarlet flowers, brilliant. July and Aug..... .25 2.50
- LYTHRUM roseum superbum.** 3 ft. Spikes of deep rose-colored flowers. Sept. .25 2.50
- MONARDA didyma (Oswego Tea).** 3 ft. Aromatic foliage and bright scarlet flowers. June to Sept..... .25 2.50
- mollis.** Lilac..... .25 2.50

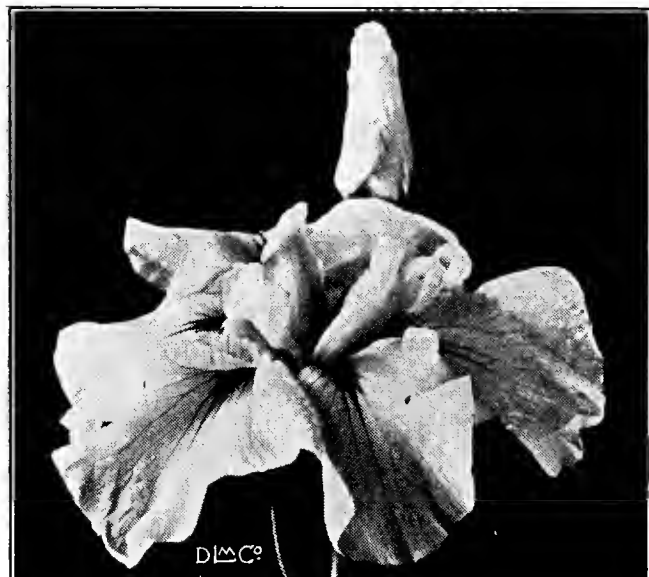

Japanese Iris

- MYOSOTIS palustris (Forget-me-not).** 10 in. Flowers all Summer. Fine blue..... .25 2.50
- NEPETA mussini.** Dwarf, covered with light blue flowers. Fine for rock garden. May to Sept... .25 2.50
- OENOTHERA (Evening Primrose).**
- fruticosa major.** Large golden yellow flowers. July. 2 ft..... .25 2.50
- youngi.** 18 in. Bright yellow. June to Sept..... .25 2.50
- PAPAVER orientale (Oriental Poppy).** 3 ft. Brilliant scarlet with black center; very showy. June.... .25 2.50
- PENTSTEMON barbatus torreyi (Beard-tongue).** 4 ft. Bright scarlet flowers. July to Sept..... .25 2.50
- digitalis.** 3 ft. Pure white. July and August.... .25 2.50
- PEONIES (Paeonia).** One of the hardiest flowering plants and rivaled only by the Rose Each
- Alsace-Lorraine.** White, much like the white pondlily. Late \$1.50
- Couronne d'Or.** Pure white globular flowers, with amber yellow stamens. Late..... 1.00
- Dorchester.** Large and compact. Pale hydrangea pink. Fragrant; late..... 1.00
- Dorothy Allison.** Bright, fresh-pink; dwarf habit. Midseason. Single..... 2.00
- Duchesse de Nemours.** Medium-sized, pure white bloom. Strong, free bloomer; fragrant; early..... .75

- Eugenie Verdier.** Flesh pink; extra fine variety, late..... 1.50
- Felix Crousse.** Large, globular bloom. Brilliant red and a free bloomer. Fragrant; midseason..... 1.00
- Festiva Maxima.** Very large; pure white center, petals tipped with bright crimson. Midseason..... .75
- Georgiana Shaylor.** Pale pink flecked with crimson; fine blooms late in the season..... 1.50

- Ginette.** A flesh pink variety, very Each fragrant. Early..... \$1.50
- James Kelway.** A pure white variety, blooms early midseason..... 1.50
- Lady Lilian Ogle.** Early single, pure white, fragrant..... 1.00
- Le Cygne.** Pure milk white, incurved petals, midseason..... 3.00
- Madame de Verneville.** Very large; pure white with center petals blush, tipped carmine.... .75
- Monsieur Jules Elie.** Large, compact. Pale lilac-rose with silvery reflex; fragrant, mid-season..... 1.50
- Norfolk.** Deep shell-pink with cup-shaped petals. Late..... 1.00
- Venus.** Delicate shell-pink, compact bloom.. 1.50
- Walter Faxon.** Large blooms; bright rose, deepening toward the center; fragrant; mid-season..... 3.00

- PEONIA officinalis, alba, rubra, rosea** 1.00
- PEONIAS, Mixed**..... Doz. \$10.00 1.00

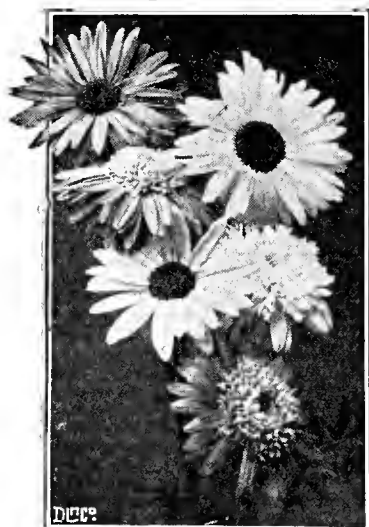

Pyrethrum



Oriental Poppy

PHLOX paniculata (Hardy Perennial Phlox). A succession of flowers of greatest beauty, from early July until frost, in softest tones of pink and rose, salmon and white in great panicked blooms.
30c. each, \$2.50 per doz., except where noted.
Alpha. Brilliant rosy pink, long trusses. Early.
Annie Cook. Flesh pink. Tall.
B. Comte. French purple. Medium.
Dantons. Light madder, maroon eye.
Deutschland. A rich scarlet variety.
Elizabeth Campbell. Light salmon. Medium. Ea. 35c.
Enchantress. Salmon pink. Medium.
Europe. White; decided crimson eye. Tall.
Fiancee. Pure white. Medium.
Frau Antoine Buchner. Largest pure white. Medium.
Jeanne d'Arc. Pure white; late. Medium.
Le Caid. Pink; darker eye.
Lord Raleigh. Purple white markings. Tall.
Maid Marion. Soft lavender large flower. Medium.
Miss Lingard. White with pale pink center. Early.
Mrs. Jenkins. Beautiful clear white. Medium.
Mrs. Scholton. Salmon-scarlet. Medium.
Pantheon. Brilliant rose, very effective. Tall.
Peachblow. Pale pink, lighter edge. Medium.
Rheinlander. Beautiful salmon-pink. Medium.
Rijnstroom. Color of Paul Neyron rose. Tall.
Sir Edwin Landseer. Flowers bright crimson.
Special French. Beautiful clear pink. Tall.
Thor. Deep salmon pink. Tall.
W. C. Egan. Delicate lilac, reddish eye. Medium.
 Each Doz.

PHLOX divaricata. 1 ft. Dwarf. Pale blue. Native variety. May and June.....\$0.25 \$2.50
subulata (Moss Pink). 4 to 6 in. Pink. April and May..... .25 2.50
subulata alba. 4 to 6 in. White..... .25 2.50

PHYSOSTEGIA virginica (False-dragonhead). One of the most attractive Mid-summer plants, covered with clear pink, heath-like flowers. July and Aug..... .25 2.50

PLATYCODON grandiflorum (Wahlenbergia). 2½ ft. Large blue, Campanula-like flowers. July to Oct..... .25 2.50
grandiflorum album. 2½ ft. White.... .25 2.50
mariesi. 1½ ft. Violet-blue..... .25 2.50

POLEMONIUM coeruleum (Jacobs-ladder). 2 ft. Light blue. May to July..... .25 2.50

PRIMULA vulgaris (English Primrose). Bright canary-yellow. April and May.. .25 2.50

PYRETHRUM roseum (Persian Daisy). 2 ft. One of the showiest flowers; of great value for cutting. June to July. Single Mixed..... .25 2.50
uliginosum (Giant Daisy). 4 ft. Large white. Aug. and Sept..... .25 2.50

RANUNCULUS acris fl. pl. (Double Buttercup). 2 ft. Double yellow. May and June. .25 2.50

RUDBECKIA lanceolata (Goldenglow). 5 to 6 ft. Double yellow, Cactus-Dahlia-like flowers. July to Sept..... .25 2.50
newmanni. 2½ ft. Golden yellow with purple cone. July to Oct..... .25 2.50
purpurea. 3 ft. Large, reddish purple, with dark, cone-shaped center of brown. July to Oct..... .25 2.50

SEDUM acre (Golden-moss). 4 in. Bright yellow, with green foliage. May to July. Each Doz. \$0.25 \$2.50
album. 4 in. Green foliage, white flowers. July and Aug..... .25 2.50
sexangulare. Dark green foliage. Yellow flower. 6 in..... .25 2.50
spectabile (Showy Stonecrop). 18 in. An erect growing plant with broad green foliage and large heads of handsome rose-colored flowers.25 2.50
spectabile, Brilliant. 1 ft. Sept. and Oct. A more richly colored form of *S. spectabile*, being a bright amaranth-red..... .25 2.50

SPIRAEA filipendula fl. pl. 2 ft. Double white. June and July..... .30 3.00

STATICE latifolia (Sea Lavender). 1½ ft. Violet-blue. July to Sept..... .25 2.50

STOKESIA cyanea (Cornflower Aster). 2 ft. Lavender-blue. A native plant; fine for cutting. July to Oct..... .25 2.50
alba..... .25 2.50

TRITOMA uvaria grandiflora (Flameflower). 4 ft. Orange-scarlet. Aug. to Nov..... .25 2.50

TROLLIUS europaeus (Globeflower). 1½ ft. Bright yellow. June to Sept..... .35 3.50

VERONICA (Speedwell).
longifolia sessilis. One of the handsomest white flowering plants. 2 ft. July to Sept..... .25 2.50
spicata. 2 ft. Blue. June to Aug..... .25 2.50

VINCA minor (Myrtle). Creeping evergreen; good for covering ground in shady places. Bright blue flowers. April to July..... .25 2.50

VIOLA cornuta (Tufted Pansies). 6 in. Profuse bloomers from April to frost..... .25 2.50
cornuta alba. White. 6 in..... .25 2.50
cornuta var. purpurea. Deep violet-blue. Very free flowering..... .25 2.50
Jersey Gem. Rich violet color, fragrant; fine for borders or rockeries..... .25 2.50



Sedum spectabile

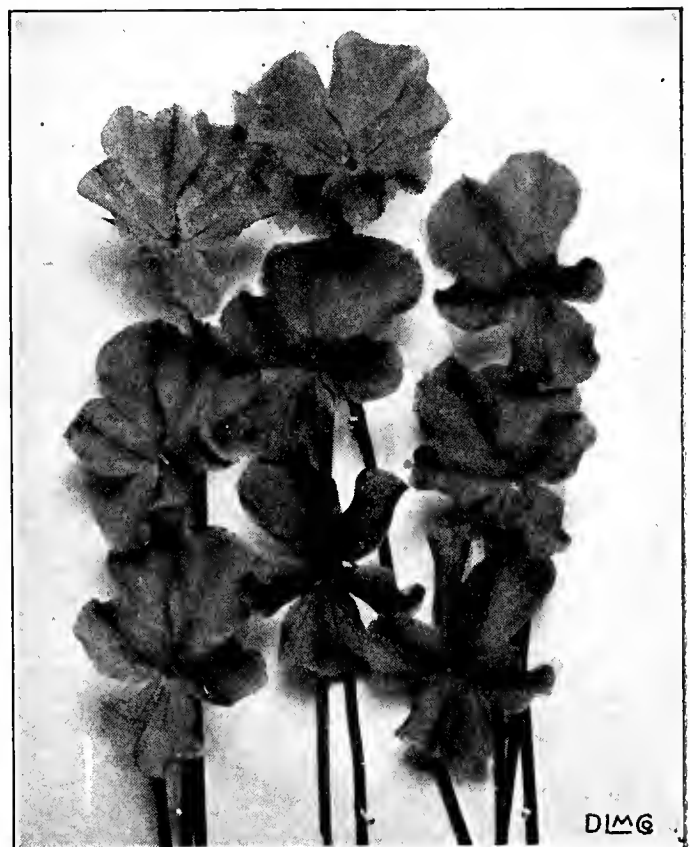

Viola Jersey Gem



HYBRID TEA (Everblooming) ROSES

Two-year dormant plants 60c. each, \$6.00 per doz., \$45.00 per 100, except where noted

- Briarcliff.** Large, pointed buds, and double, high-centered blooms of brilliant rose pink, fragrant and long lasting.
- Dame Edith Helen.** Enormous, very double, pure pink blooms, continually produced. Strong growth.
- Dorothy Page-Roberts.** Glistening, coppery pink, semi-double blooms, suffused apricot.
- Duchess of Wellington.** A delightfully fragrant Rose. Intense saffron yellow.
- Eldorado.** Golden buds flushed with red, opening to clear yellow, cupped blooms; slightly fragrant.
- Etoile de France.** Deep crimson with cerise red center.
- Frank W. Dunlop.** Very large buds and flowers of deep, brilliant rose pink; very double and highly perfumed.
- General-Superior Arnold Janssen.** Deep rose pink. Flowers large, double, lasting.
- Golden Gleam.** Bright buttercup yellow without shading, outer petals streaked scarlet.
- Gruss an Teplitz.** Rich scarlet; free bloomer.
- Jonkheer J. L. Mock.** Outside of petals carmine, inside flesh pink.
- Kaiserin Auguste Viktoria.** Cream shaded lemon.
- Killarney.** Flesh, shaded white, suffused pale pink.
- Killarney White.** Pure white; productive; constant.

- Konigin Carola.** Color a beautiful satiny rose; reverse of petals silvery rose.
- Lady Hillingdon.** Deep apricot yellow.
- Lady Ursula.** Flesh pink; tea-scented; free bloomer.
- Laurent Carle.** Brilliant velvety carmine; free blooming.
- Los Angeles.** Flame pink, with salmon and coral shadings. Splendid cut flower.
- Mme. Butterfly.** Similar to Ophelia but larger flower.
- Mme. Edouard Herriot.** Coral or brick red.
- Mme. Caroline Testout.** Beautiful silvery rose.
- Mrs. A. R. Barraclough.** Enormous pure pink flowers shaded with clear light yellow at base of petals.
- Mrs. Aaron Ward.** Color Indian yellow, shading to lemon cream at the edges of petals.
- Ophelia.** Salmon-flesh, shading to rose.
- Radiance.** Soft carmine pink. Double; sweet scented.
- Red Radiance.** A crimson sport of Radiance.
- Reine Marguerite d'Italie.** Deep crimson, almost maroon. A great bloomer, especially in the Fall; fragrant.
- Rev. F. Page-Roberts.** Copper red buds opening to golden yellow; very large; fragrant.
- Sensation.** Deep blackish maroon, large and highly perfumed in bud and color.
- Souvenir de Claudius Pernet.** The best and one of the few really yellow Roses; pointed bud; glossy foliage.
- Sunburst.** Rich yellow, shaded copper and orange.
- Talisman.** Most vividly colored rose, apricot shading to yellow at the base.
- Ville de Paris.** Round buds and big, globular blooms of a clear yellow.

NEW INTRODUCTIONS

\$1.00 each, \$10.50 per doz.

- Autumn.** Gorgeous flowers which blend together the Autumnal shades of russet brown, bronzy red and rich yellow. Free bloomer.
- Diana.** Delicate flesh, blended with lemon tints on background of cream. Large.
- Duchess of Athol.** Light bronze, vividly splashed with orange and old gold.
- Lady Fortevoit.** Delightfully sweet-scented Rose, saffron yellow, suffused with carmine and orange.
- Mrs. Pierre du Pont.** Reddish gold buds turn to fragrant blooms of deep golden yellow.
- Patience.** Many flowers of distinctive scarlet carmine color, in continuous profusion.
- President Herbert Hoover.** An outstanding novelty of maroon, orange and gold.
- Syracuse.** A new Rose, outstanding in the brilliance of its bright crimson hue. Blooms hold their color and shapeliness when cut.



President Herbert Hoover

HYBRID PERPETUAL ROSES

Two-year dormant plants, 60c. each, \$6.00 per doz.,
\$45.00 per 100

- Alfred Colomb.** Extra large, very double; color rich crimson; fragrant.
American Beauty. Very double; deep crimson.
Anna de Diesbach. Brilliant carmine; fragrant.
Baron de Bonstettin. Blackish crimson.
Captain Hayward. Bright crimson carmine.
Clio. Flesh color, shading to rose in center. Large.
Fisher Holmes. Dark velvety crimson.
Frau Karl Druschki. Pure white; large and free flowering.
General Jacqueminot. Brilliant crimson; fragrant.
George Arends. The Pink Druschki. Soft pink, and free blooming; distinct.
Mme. Gabriel Luizet. Beautiful satiny pink.
Magna Charta. A bright, clear pink.
Mrs. John Laing. A constant blooming hardy Rose. Color brilliant shell pink.
Mrs. R. G. S. Crawford. Deep rose pink.
Paul Neyron. A deep rose color; large.
Prince Camille de Rohan. Deep velvety crimson.
Soleil d'Or. Golden yellow, shaded Nasturtium red.
Ulrich Brunner. Bright cherry red; fragrant.

CLIMBING ROSES

Two-year dormant plants, 50c. each, \$5.00 per doz.,
except where noted

- American Pillar.** Chaste pink, white center; single.
Aviateur Bleriot. Rich, deep saffron yellow; fragrant.
Blaze (U. S. Plant Patent No. 10). Everblooming Paul's Scarlet Climber. A vigorous Climber producing flowers of the blazing color of Paul's Scarlet and the everblooming habit of Gruss an Teplitz. \$2.00 each.
Bonfire. Cherry crimson; early.
Chaplin's Pink Climber. Rich pink; large.
Christine Wright. Bright wild rose pink.
Climbing American Beauty. Rose pink; fragrant.
Crimson Rambler. Large clusters of crimson flowers.
Dr. W. Van Fleet. Flesh pink. Double and fragrant.
Dorothy Perkins. Soft shell pink.
Emily Gray. Long tapering, golden yellow buds. \$1.00 ea.
Excelsa. Intense crimson maroon. Healthy foliage; fine.
Hiawatha. Single. Crimson, with white eye.

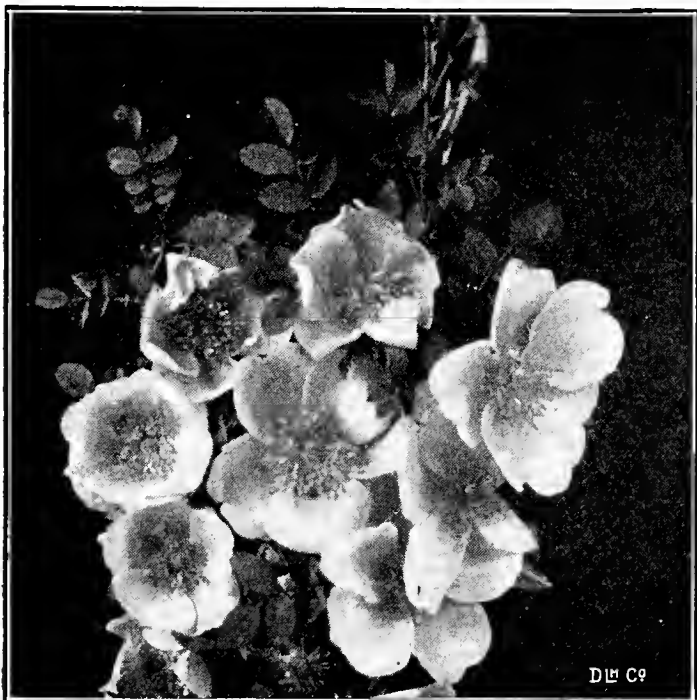

Rosa Hugonis



American Beauty

- Mary Wallace.** Semi-double, rose pink, with salmon base.
Max Graf. Trailing Hybrid-Rugosa Rose. Valuable as a ground cover. Foliage of the Rugosa type. Flowers single and bright pink. 75c. each, \$8.00 per doz.
Mme. Gregoire Staechelin. Deep maroon in bud, changing to carmine; pink center; fragrant. \$1.00 each.
Paul's Scarlet Climber. Vivid scarlet, semi-double flowers of medium size. Produced in large clusters.
Scorcher. Vigorous and hardy, with handsome vermilion flowers. \$2.00.
Silver Moon. Silvery white. Foliage is mildew proof.
Tausendschoen. Soft pink, turning to flesh.
The New Dawn. The everblooming Dr. W. Van Fleet. \$1.50.
White Dorothy Perkins.

BABY RAMBLER ROSES

Two-year dormant plants, 60c. each, \$6.00 per doz.,
\$45.00 per 100

- Baby Crimson Rambler.** **Jessie.** Bright scarlet.
 Crimson.
Baby Dorothy. Pink.
Baby Ideal. Vivid scarlet.
Miss Edith Cavell. Red, white eye.
Orleans. Red.

MISCELLANEOUS HARDY ROSES

- Rosa rugosa rubra.** Red. 60c. each, \$6.00 per doz.
Rosa rugosa alba. White. 75c. each, \$7.50 per doz.
F. J. Grootendoorst. A strong, shrubby grower. The flowers are produced in large clusters like the Crimson Baby Rambler. 2 year plants, 60c. each, \$6.00 per doz.
Rosa Hugonis (Golden Rose of China). A hardy, single, yellow Rose. Strong growing shrub. Early. 75c. each, \$8.00 per doz.
Rosa wichuraiana (Memorial Rose). Single, pure white 50c. each.

Sweet Pepperbush (*Clethra alnifolia*)*Hydrangea arborescens grandiflora*

DECIDUOUS SHRUBS

Ornamental shrubs occupy an important place in the home garden. They present a variety of color, season of bloom and type of growth, as well as producing brilliant colored foliage in the Fall and bright colored berries in the Winter.

- ALMOND** (*Amygdalus*). Produces double, rose colored flowers in great profusion in early Spring. 1½ to 2 ft., 75c. each.
- ALTHAEA** (*Hibiscus syriacus*) **Rose-of-Sharon**. Tall growing, late flowering shrubs of unusual beauty. Pink, purple, red and white. Bush form, 2 to 3 ft., 60c. each; 3 to 4 ft., 75c. each; tree form, \$1.00 each.
- ARALIA** (*Acanthopanax pentaphylla*). A graceful shrub with spiny branches and bright green foliage. 2 to 3 ft., 60c. each.
- AZALEA arborescens** (Sweet Azalea). Fragrant white flowers in June. 1 to 1½ ft., \$2.25 each; 1½ to 2 ft., \$3.00 each.
- kaempferi** (Torch Azalea). Orange red. 1½ ft., \$3.00 each; 2 to 3 ft., \$5.00 each.
- lutea** (Flame Azalea). Flame red flowers late in May. 1 to 1½ ft., \$2.00 each; 1½ to 2 ft., \$2.75 each.
- mollis** (Chinese Azalea). Mixed colors. 1 to 1½ ft., \$3.00 each.
- nudiflora** (Pinxterflower). Deep pink to reddish purple. 1 to 1½ ft., \$2.00 each; 1½ to 2 ft., \$2.75 each.
- poukhanensis** (Korean Azalea). Low growing; pale lilac purple. 15 to 18 in., \$3.00 each; 1½ to 2 ft., \$3.50 each.
- viscosa** (Swamp Azalea). Fragrant white flowers in July; prefers damp soil. 1 to 1½ ft., \$1.25 each; 2 ft., \$2.25 each.
- BARBERRY, Japanese**. See **Hedge Plants**, page 79.
- Redleaf Japanese** (*Berberis thunbergii atropurpurea*). Similar to the Japanese in habit. The foliage which is a bright red lasts the entire season. 25c. and 50c. each.
- BAYBERRY** (*Myrica cerifera*). A valuable shrub for poor and sandy soils. White, waxy berries. 1½ to 2 ft., 75c. each.
- BUTTERFLYBUSH** (*Buddleia magnifica*). An attractive shrub with rosy purple flowers. 50c. each.
- CAROLINA ALLSPICE** (*Calycanthus floridus*). An old-fashioned shrub with Pineapple-scented, chocolate colored flowers. Thrives in partial shade. 60c. each.
- CORALBERRY** (*Symphoricarpos vulgaris*). Clusters of coral red berries last throughout the Winter. 2 to 3 ft., 50c. each.
- DEUTZIA gracilis**. Dwarf; white flowers cover the entire plant in May. 1 to 1½ ft., 40c. each; 1½ to 2 ft., 50c. each.
- lemoinei**. Medium growth. White flowers on erect stems in June. 1½ to 2 ft., 60c. each.
- Pride of Rochester**. Tall; double white flowers tinged with pink; in late June. 2 to 3 ft., 60c. each; 3 to 4 ft., 75c. each.
- DOGWOOD** (*Cornus*). Strong growing shrubs, attractive for their bloom, berries, leaf coloring and colored bark.
- Cornus alba**. Flowers white, fruit blue, branches red. 60c. each.
- Cornus elegantissima**. Green foliage, edged with white; branches red. 2 to 3 ft., 75c. each.
- Cornus stolonifera flaviramea**. Flowers white, branches yellow. 2 to 3 ft., 60c. each.
- EUONYMUS alatus** (Winged Burningbush). A handsome shrub of medium growth. Peculiar winged branches; foliage light green changing to bright crimson in Autumn. 2 to 3 ft., 60c. each; 3 to 4 ft., \$1.00 each.
- alatus compacta** (Dwarf Winged Burningbush). A very choice, compact variety of the above. Does well in the shade. 1 to 1½ ft., 40c. each; 1½ to 2 ft., 60c. each; 2 to 3 ft., 75c. each.
- FORSYTHIA** (Golden Bell). First of the Spring flowering shrubs. Rich green foliage; tall and graceful in habit.
- fortunei**. Upright growth. 2 to 3 ft., 50c. each; 3 to 4 ft., 75c. each.
- intermedia**. Medium growth. 2 to 3 ft., 50c. each; 3 to 4 ft., 75c. each.
- suspensa**. Weeping in habit. 3 to 4 ft., 75c. each.
- FRINGE TREE** (*Chionanthus virginica*). A large growing shrub with heavy foliage and lacy white flowers. 2 to 3 ft., \$1.50 each.
- HONEYSUCKLE** (*Lonicera*). Tall, bushy, hardy shrubs.
- morrowi Honeysuckle** (*L. morrowi*). Medium height, drooping branches, white flowers, red fruit. 3 to 4 ft., 75c. each.
- Tatarian Honeysuckle** (*L. tatarica*). Tall, pink flowers, crimson fruit. 2 to 3 ft., 50c. each; 3 to 4 ft., 75c. each.
- White Tatarian Honeysuckle** (*L. tatarica alba*). Tall, white flowers; crimson fruit. 3 to 4 ft., 75c. each.

DECIDUOUS SHRUBS—Continued

HYDRANGEA arborescens grandiflora (Hills of Snow). Large clusters of white flowers in Midsummer. 2 to 3 ft., 60c. each.

paniculata grandiflora. The old-fashioned, common variety with large heads of white flowers in late Summer which turn a bright pink in Fall. 1½ to 2 ft., 35c. each; 2 to 3 ft., 50c. each; 3 to 4 ft., 75c. each.

Standard or Tree Hydrangea. 3 to 4 ft., \$1.00 each.

JETBEAD (*Rhodotypos kerrioides*). Medium height; single, white flowers followed by shiny, black fruit which last throughout the Winter. 2 to 3 ft., 60c. each; 3 to 4 ft., 75c. each.

KOLKWITZIA amabilis (Beautybush). A free growing shrub with tubular pink flowers produced abundantly in rounded clusters the whole length of the branches. \$1.00 each.

LILAC (*Syringa*). Old-fashioned favorites familiar to all.
Common Purple. 1½ to 2 ft., 50c. each; 2 to 3 ft., 60c. each.

Common White. 1½ to 2 ft., 50c. each; 2 to 3 ft., 75c. each.

Persian Lilac. Very fragrant, pale purple flowers in loose panicles. 2 to 3 ft., 75c. each.

Villosa Lilac. Heavy bright green foliage, flowers rosy white and fragrant; late blooming. 2 to 3 ft., 75c. each.

HYBRID LILACS. Unlike the old varieties, this type bloom when very young and their double and single blooms are produced in a wide range of color. The varieties listed are priced as follows: 1½ to 2 ft., 60c. each; 2 to 3 ft., 75c. each; 3 to 4 ft., \$1.00 each:

Single Varieties:

- Amelia Dupret.** Pale lilac.
- Chas. X.** Reddish purple.
- Congo.** Dark crimson.
- Marie Legraye.** White.
- Rubra de Marly.** Purple.
- Souv. de Ludwig Spaeth.** Red.

Double Varieties:

- Alphonse Lavallee.** Light blue.
- Belle de Nancy.** Satin pink.
- Doyonne Keteleer.** Light pink.
- Marlyensis Pallida.** Reddish purple.
- Mme. Lemoine.** White.
- Ville de Troyes.** Dark purple.

PEPPERBUSH (*Clethra alnifolia*). Medium growth, white fragrant flowers in Midsummer. 1½ to 2 ft., 50c. each.

PRIVET (*Ligustrum*). Hedge varieties, see page 79.
Regel Privet (*L. regelianum*). Low-spreading shrub of graceful habit. A fine border shrub. 1½ to 2 ft., 35c. each, \$4.00 per doz.

JAPANESE QUINCE (*Cydonia japonica*). Dark green, glossy foliage; scarlet flowers in May. 1½ to 2 ft., 60c. each. 2 ft. to 3 ft., 75c. each.



Fruits of *Viburnum opulus*

FLOWERING RASPBERRY (*Rubus odoratus*). A shade growing plant of medium height; flowers rosy purple. 50c. each.

SIBERIAN PEA-TREE (*Caragana arborescens*). A hardy, tall growing shrub with dark green wood; light green foliage and small, pea-shaped flowers in June. 2 to 3 ft., 60c. each.

SMOKE BUSH (*Rhus cotinus*). Much admired for its clusters of purplish, misty flowers in June. 2 to 3 ft., 75c. each.

SPIREA (*Spiraea*). An interesting family of flowering shrubs, covering a wide season of bloom. Very hardy.

Anthony Waterer. Dwarf; rose pink blooms in July and Aug. 1 to 1½ ft., 50c. each; 1½ to 2 ft., 60c. each.

bumalda. A light pink variety of the above. 1 to 1½ ft., 50c. each.

froebeli. A stronger grower than Anthony Waterer; rose pink blooms in July and Aug. 1½ to 2 ft., 50c. each; 2 to 3 ft., 75c. each.

prunifolia. The true Bridalwreath. Tiny white flowers in great masses along the stems are produced late in May. 2 to 3 ft., 60c. each; 3 to 4 ft., 75c. each.

thunbergi. Medium growth; small white flowers in early May; graceful habit. 2 to 3 ft., 60c. each.

trichocarpa (Korean Spirea). A newer variety much like *S. vanhouttei*, but blooming about two weeks later. \$1.00 each.

vanhouttei. The finest of all Spireas. Graceful arching branches are completely covered with white flowers in June. 2 to 3 ft., 50c. each; 3 to 4 ft., 75c. each; 4 to 5 ft., \$1.00 each.

STEPHANANDRA flexuosa. Spreading and drooping in habit; foliage finely cut and lacy; flowers white. 2 to 3 ft., 75c. each.

SNOWBERRY (*Symphoricarpos racemosus*). A bushy shrub with slender branches which droop gracefully; white waxy berries cover the plant in Fall. 2 to 3 ft., 60c. each.

SYRINGA.

Common Syringa (*Philadelphus coronarius*). Tall, pure white, fragrant flowers in June. 2 to 3 ft., 50c. each; 3 to 4 ft., 75c. each.

Golden Syringa (*Philadelphus coronarius aurca*). A dwarf variety with bright yellow foliage. 1 to 1½ ft., 60c. each; 1½ to 2 ft., 75c. each.

LARGE-FLOWERED SYRINGA (*Philadelphus grandiflorus*). A vigorous growing variety; white flowers. 2 to 3 ft., 50c. each; 3 to 4 ft., 75c. each.

VIBURNUM.

Dwarf Viburnum (*V. opulus nana*). A dense, compact, dwarf plant useful for very low borders. 10 to 12 in., 40c. each.

European High Bush Cranberry (*V. opulus*). A tall growing shrub producing large clusters of scarlet fruit late in the Summer. 2 to 3 ft., 60c. each; 3 to 4 ft., 75c. each.

Common Snowball (*V. opulus sterilis*). An old favorite. 1½ to 2 ft., 50c. each; 2 to 3 ft., 75c. each.

Japan Snowball (*V. plicatum*). A compact grower with heavy foliage. Round white flowers in May. 1½ to 2 ft., 75c. each.

Single Japan Snowball (*V. tomentosum*). 1½ to 2 ft., 60c. each.

Mayflowering Viburnum (*V. carlesi*). Compact and bushy in growth; fragrant, pink flowers in May. A choice variety. 1 ft., \$1.00 each; 1½ ft., \$2.00 each; 2 ft., \$3.00 each.

WEIGELA. These valuable shrubs produce trumpet-shaped flowers in great profusion during May and June.

candida. White. 2 to 3 ft., 75c. each.

Eva Rathke. Dark reddish green foliage; dark red blossoms throughout Summer. 1½ to 2 ft., 75c. each.

rosea. A tall growing variety, producing pink flowers in June. 2 to 3 ft., 50c. each; 3 to 4 ft., 75c. each.

Variegated. A dwarfish type with white margined leaves; flowers white. 1½ to 2 ft., 50c. each; 2 to 3 ft., 75c. each.

DECIDUOUS TREES

ASH. Fraxinus

American White (*F. americana*). A large, broad-headed tree suitable for lawn or street planting. 8 to 10 ft., \$2.00.

BEECH. Fagus

European Beech (*F. sylvatica*). Light green foliage; compact in habit. 2 to 3 ft., \$1.50 each.

Purple Beech (*F. sylvatica purpurea*). Rich purplish foliage. A desirable lawn tree. 1½ to 2 ft., \$2.50 each; 2 to 3 ft., \$3.00 each; 3 to 4 ft., \$4.00 each.

BIRCH. Betula

European White Birch (*B. alba*). 5 to 6 ft., \$1.75 each.

Cutleaved Weeping Birch (*B. alba laciniata*). 3 to 4 ft., \$1.00 each; 4 to 5 ft., \$1.50 each; 5 to 6 ft., \$2.00 each.

Canoe Birch (*B. papyrifera*). 6 to 8 ft., \$2.00 each.

CATALPA

Umbrella Catalpa (*C. bungei*). Dense, globe-shaped heads on slender stems. 1 yr. heads, \$2.00; 2 yr. heads, \$3.00.

Western Catalpa (*C. speciosa*). A rapid growing tree with large, heart-shaped leaves. Purple and white flowers. 6 to 8 ft., \$1.00 each; 8 to 10 ft., \$1.25 each.

FLOWERING CRAB. Malus

The Flowering Crabs are slow growing trees with fragrant blossoms from pure white to deep red. Ideal trees for garden border or single specimens.

The following varieties, 2 to 3 ft., \$1.00 each;

3 to 4 ft., \$1.50 each; 4 to 5 ft., \$2.50 each

Bechtels Crab (*M. ioensis plena*). Double pink in clusters.

Carmine Crab (*M. atrosanguinea*). Brilliant carmine.

Japanese Crab (*M. floribunda*). Pinkish buds, white flowers.

Parkman Crab (*M. halliana parkmani*). Double, rose red.

Redvein Crab (*M. niedzwetzkyana*). Early flowering red.

DOGWOOD. Cornus

Redflowering Dogwood (*C. florida rubra*). 2 to 3 ft., \$2.00 each; 3 to 4 ft., \$3.00 each; 4 to 5 ft., \$4.00 each.

Whiteflowering Dogwood (*C. florida*). 2 to 3 ft., \$1.00 each; 3 to 4 ft., \$1.50 each; 4 to 5 ft., \$2.00 each.



Catalpa bungei

ELM. Ulmus

American Elm (*U. americana*). 10 to 12 ft., \$2.50 each.

Chinese Elm (*U. pumila*). 5 to 6 ft., \$1.00 each; 6 to 8 ft., \$1.50 each; 8 to 10 ft., \$2.50 each.

Moline Elm (*U. americana moline*). A large, fast growing tree with handsome foliage. 6 to 8 ft., \$1.50 each; 8 to 10 ft., \$2.50 each; 10 to 12 ft., \$3.50 each.

HAWTHORN. Crataegus

Scarlet Hawthorn (*C. oxyacantha pauli*). 4 to 5 ft., \$1.75 each.

White Hawthorn (*C. oxyacantha alba*). 4 to 5 ft., \$1.75 each.

JUDAS-TREE. Cercis

Redbud or Judas-tree (*C. canadensis*). 4 to 5 ft., \$1.50 each.

LINDEN. Tilia

American Linden (*T. platyphyllos*). 6 to 8 ft., \$1.75 each.

European Linden (*T. vulgaris*). 6 to 8 ft., \$1.75 each; 8 to 10 ft., \$3.00 each.

MAIDENHAIR-TREE. Ginkgo

Maidenhair-tree (*G. biloba*). Fan-shaped foliage, resembling the Maidenhair Fern. Very ornamental. 6 to 8 ft., \$3.50 each; 8 to 10 ft., \$4.50 each.

MAGNOLIA

Soulangeana (*Saucer Magnolia*). Prices on application.

MAPLE. Acer

Norway Maple (*A. platanoides*). 6 to 8 ft., \$1.50 each; 8 to 10 ft., \$2.00 each; 10 to 12 ft., \$3.50 each.

Rock Maple (*A. saccharum*). Same sizes and prices of Norway.

Schwedleri Maple (*A. schwedleri*). Purplish foliage. A very desirable lawn tree. 5 to 6 ft., \$2.00 each; 6 to 8 ft., \$3.00 each; 8 to 10 ft., \$4.00 each.

Silver Maple (*A. dasycarpum*). A rapid growing tree for lawn or street planting. 6 to 8 ft., \$1.25 each; 8 to 10 ft., \$1.75 each; 10 to 12 ft., \$2.50 each.

Wier's Cutleaved Weeping Maple (*A. dasycarpum wieri*). A graceful, drooping tree of rapid growth; ideal as a lawn specimen. 6 to 8 ft., \$1.75 each; 8 to 10 ft., \$2.25 each; 10 to 12 ft., \$3.50 each.

Bloodleaved Japan Maple (*A. palmatum atropurpureum*). Very dwarf; deep blood red foliage. 1 to 1½ ft., \$3.00 each.

MOUNTAIN-ASH. Sorbus

European Mountain-ash (*S. aucuparia*). White flowers in May; clusters of orange red berries in Autumn; medium growth. 5 to 6 ft., \$1.25 each; 6 to 8 ft., \$1.75 each; 8 to 10 ft., \$2.50 each.

MULBERRY. Morus

Tea's Weeping Mulberry (*M. tatarica pendula*). A dwarf weeping tree with long, pendulous branches which droop to the ground. \$2.50 each.

OAK. Quercus

Pin Oak (*Q. palustris*). Pyramidal habit, deeply cut leaves. 5 to 6 leaves, \$2.75 each; 6 to 8 ft., \$3.50 each; 8 to 10 ft., \$5.00 each.

Red Oak (*Q. rubra*). 6 to 8 ft., \$2.50 each.

POPULAR. Populus

Carolina Poplar (*P. deltoides*). Tall and spreading, rapid growth. 8 to 10 ft., \$1.25 each; 10 to 12 ft., \$1.50 each.

Lombardy Poplar (*P. nigra italica*). A tree of rapid growth, useful for screening. The trees which we offer are bushy and the branches start from the ground. 6 to 8 ft., 50c. each, \$5.50 per doz.; 8 to 10 ft., \$1.00 each, \$10.00 per doz.; 10 to 12 ft., \$1.50 each, \$15.00 per doz.; 12 to 14 ft., \$2.00 each, \$20.00 per doz.

WILLOW. Salix

Golden Bark Willow (*S. vitellina aurea*). 5 to 6 ft., \$1.00 each.

Laurel-leaved Willow (*S. pentandra*). 6 to 8 ft., \$1.00 each.

Thurlo's Willow (*S. elegantissima*). 8 to 10 ft., \$1.75 each.

Wisconsin Weeping Willow (*S. blanda*). 8 to 10 ft., \$1.75 each.

Hardy Climbing Plants and Flowering Vines

ACTINIDIA arguta. Oval, glossy leaves and clusters of fragrant flowers.....	Each	Doz.
	\$0.75	\$7.50
AKEBIA quinata. Clover-like leaves and fragrant, velvety purple flowers.....	.75	7.50
AMPELOPSIS quinquefolia (Virginia Creeper). Rapid grower.....	.50	5.00
engelmanni. A creeper that clings to stone or wood as tightly as English Ivy.	.50	5.00
veitchi (Japanese or Boston Ivy). Very fine for covering walls, rocks, etc.....	.75	7.50
Pot-grown, ready May 15.....	1.00	11.00
ARISTOLOCHIA siphon (Dutchmans-pipe). Heart-shaped leaves; the brown flowers resemble a pipe.....	1.00	10.00
BIGNONIA radicans (Trumpetflower). Large trumpet-shaped, orange and red flowers.	.60	6.00
CELASTRUS orbiculatus (Japanese Bittersweet). A strong climbing shrub with glossy green foliage, and in Autumn covered with bright yellow fruit.....	.75	7.50
scandens (Roxbury Waxwork). Glossy leaves and clusters of orange-crimson fruit, which remains on all Winter.....	.60	6.00
CLEMATIS paniculata. Glossy, dark green foliage, and covered in the latter part of the Summer with star-like white flowers, fragrant.....	.50	5.00
Extra large.....	.75	7.50
Pot-grown, ready May 15.....	1.00	11.00
henryi. One of the best whites; very large white flowers often as much as 8 inches across. A continuous bloomer.....	1.00	10.00
jackmani. Large violet-purple; free bloomer	1.00	10.00
Mme. Edward Andre. Large carmine-red flowers; very free bloomer.....	1.00	10.00

ENGLISH IVY (<i>Hedera Helix</i>). A very desirable evergreen climber, succeeds best in a sheltered, shady situation.....	Each	Doz.
	\$1.00	\$10.00
LONICERA (Honeysuckle). Old favorites, shrubby climbers, fine for porches and trellises. Very fragrant.		
Hall's Japan. Fragrant, yellow and cream-colored flowers all Summer.....	.60	6.00
Pot-grown, ready May 15.....	1.00	11.00
Scarlet Trumpet. Clusters of tubular scarlet flowers all Summer.....	.75	7.50
HOP VINE. Vigorous and quick growing twiner, for covering arbors, etc.....	.50	5.00
LYCIUM chinense (Matrimony-vine). A climbing shrub with light green foliage and pale purple flowers; fine for northern exposures.....	.60	6.00
POLYGONUM auberti (Silver Lace Vine). A very strong growing, decorative climbing plant, staying in bloom through the Summer and Autumn. The flowers are in large sprays of pure white.....	1.75	17.00
WISTERIA sinensis (Chinese Wisteria). Long, pendulous clusters of pale blue... sinensis alba. White-flowered.....	.75	7.50
	1.00	10.00

Hedge Plants

BARBERRY thunbergi or Japanese.	Doz.	100
15 to 18 in.....	\$2.00	\$12.00
18 to 24 in.....	2.50	18.00
24 to 30 in.....	3.60	26.00
PRIVET, Amur River.		
18 to 24 in.....	2.00	8.00
24 to 36 in.....	2.40	10.00
36 to 48 in.....	3.60	15.00
California.		
12 to 18 in.....	.60	3.00
18 to 24 in.....	.90	5.00
24 to 36 in.....	1.50	8.00
36 to 48 in.....	1.80	10.00
Ibota.		
18 to 24 in.....	2.00	12.00
24 to 36 in.....	3.00	15.00
36 to 48 in.....	3.60	20.00
Ibolium. A cross between Ibota and California Privet. It has the attractive dark green leaves of the California, but is of a more branching habit, making a more compact hedge in less time. The best of all Privets.		
18 to 24 in.....	1.50	6.00
24 to 36 in.....	2.00	10.00
36 to 48 in.....	2.40	12.00

LILAC, Common. Purple, white.	Doz.	100
1½ to 2 ft.....	\$6.00	\$45.00
SPIRAEA vanhouttei.		
2 to 3 ft.....	5.00	35.00
ARBORVITAE, American.		
1½ to 2 ft.....	11.00	80.00
HEMLOCK.		
1½ to 2 ft.....	16.50	125.00
SPRUCE, Norway.		
1½ to 2 ft.....	8.00	60.00

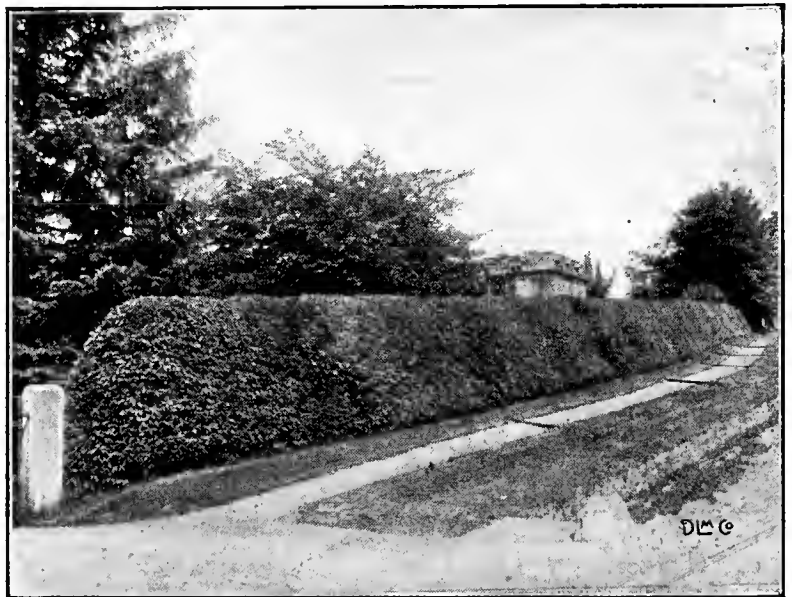

Hedge of Arborvitae

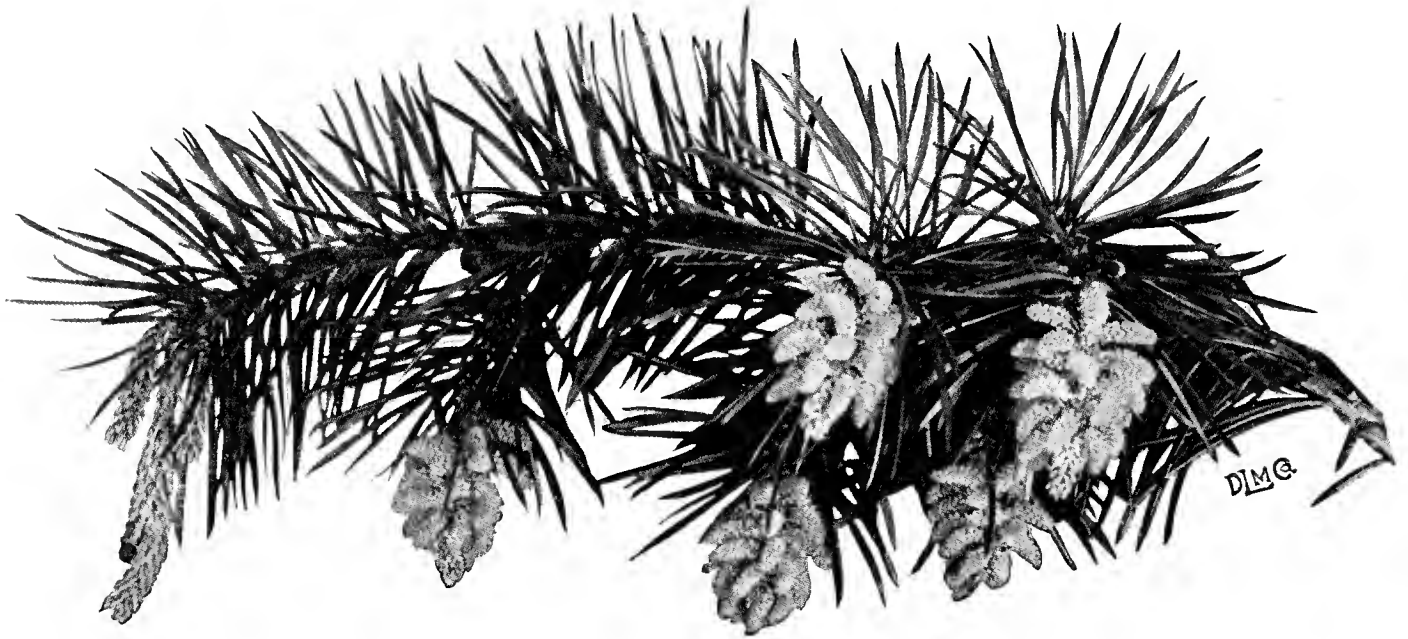

EVERGREEN TREES

ARBORVITAE. *Thuja*

American Arborvitae (*T. occidentalis*). The common upright variety used as single specimens and for hedges. 1½ to 2 ft., \$1.00 each; 2 to 2½ ft., \$1.25 each; 2½ to 3 ft., \$1.50 each; 3 to 3½ ft., \$1.75 each; 4 ft., \$3.00 each; 5 ft., \$4.00 each; 6 ft., \$6.00 each.

Dark American Arborvitae (*T. occidentalis nigra*). A newer variety with foliage much darker than the American and hardier. 2 to 3 ft., \$2.00 each; 3 to 4 ft., \$3.50 each.

George Peabody Arborvitae (*T. occidentalis lutea*). Similar to the American in habit; foliage golden yellow. 2 to 3 ft., \$2.00 each; 3 to 4 ft., \$3.00 each.

Globe Arborvitae (*T. occidentalis globosa*). Round, compact form with dense foliage; dwarf. 12 to 15 in., \$1.00 each; 15 to 18 in., \$1.25 each; 18 to 24 in., \$2.00 each.

Pyramidal Arborvitae (*T. occidentalis pyramidalis*). A most valuable upright evergreen of dense, compact habit. Foliage dark green. 1½ to 2 ft., \$1.00 each; 2 to 3 ft., \$1.75 each; 3 to 3½ ft., \$2.50 each; 3½ to 4 ft., \$3.00 each; 4½ ft., \$3.50 each; 5 ft., \$4.50 each; 5½ ft., \$5.50 each; 6 ft., \$7.00 each.

Siberian Arborvitae (*T. occidentalis wareana*). A very hardy variety holding its dark green color throughout the entire year; low and bushy in habit. 1½ ft., \$1.25 each; 2 ft., \$2.00 each; 2½ to 3 ft., \$3.00 each.

Vervaene Arborvitae (*T. occidentalis vervaeneana*). The foliage shows a light golden tinge; densely branched and of columnar habit. 1½ to 2 ft., \$1.00 each; 2 to 3 ft., \$2.00 each; 3 to 4 ft., \$2.75 each; 4 to 5 ft., \$4.00 each.

FIR. *Abies*

Veitch Fir (*A. veitchii*). A rapid growing, symmetrical tree, with dark green foliage, silvered on the underside. 2 to 2½ ft., \$3.00 each; 2½ to 3 ft., \$4.00 each.

White Fir (*A. concolor*). As a single specimen it is most ornamental; foliage of varying shades of green and blue. 1½ to 2 ft., \$2.50 each; 2 to 2½ ft., \$4.00 each; 2½ to 3 ft., \$5.00 each; 3 to 3½ ft., \$7.50 each.

HEMLOCK. *Tsuga*

Common Hemlock (*T. canadensis*). A medium sized tree of dense growth with rich green foliage; branches droop gracefully. 1½ to 2 ft., \$1.50 each; 2 to 2½ ft., \$2.25 each; 2½ to 3 ft., \$3.00 each; 3 to 3½ ft., \$3.50 each; 3½ to 4 ft., \$4.00 each; 4 to 4½ ft., \$5.00 each.

JUNIPER. *Juniperus*

Chinese Juniper (*J. chinensis*). Pyramidal in outline, with silvery green foliage. 2 to 3 ft., \$3.00 each.

Greek Juniper (*J. excelsa stricta*). A very symmetrical dwarf evergreen of conical shape; bluish green. 12 to 15 in., \$1.25 each; 15 to 18 in., \$1.75 each.

Irish Juniper (*J. communis hibernica*). Slender and columnar in habit with bluish green foliage. 1½ to 2 ft., \$1.00 each; 2 to 3 ft., \$1.50 each.

Pfitzer Juniper (*J. chinensis pfitzeriana*). A most valuable foundation evergreen. Dwarf in habit, its bluish green foliage is carried on graceful spreading branches; thrives under very unfavorable conditions. 1½ to 2 ft., \$2.50 each; 2 to 2½ ft., \$2.75 each.

Red Cedar (*J. virginiana*). A native Cedar of Pyramidal shape with foliage varying from bright green in Summer to a bronzy hue in Winter. Useful for formal effect. 2 to 3 ft., \$2.00 each; 3 to 4 ft., \$3.00 each; 4 to 5 ft., \$4.00 each; 5 to 6 ft., \$6.00 each; 6 to 7 ft., \$8.00 each.

Savin Juniper (*J. sabina*). Beautiful dark green foliage, with fan-shaped branches. Very hardy. 15 to 18 in., \$1.50 each; 18 to 24 in., \$2.00 each; 24 to 30 in., \$3.50 each.

Spreading Juniper (*J. communis*). A very hardy trailing type with bluish foliage; valuable for rock planting. 15 to 18 in., \$1.50 each; 18 to 24 in., \$2.00 each; 2 to 2½ ft., \$2.50 each; 2½ to 3 ft., \$3.00 each.

Golden Spreading Juniper (*J. communis aurea*). A golden form of the above. 15 to 18 in., \$1.50 each; 18 to 24 in., \$2.00 each; 2 to 3 ft., \$2.50 each.

Swedish Juniper (*J. communis suecica*). Very similar to the Irish Juniper, but much hardier. 15 to 18 in., \$1.00 each; 18 to 24 in., \$1.25 each; 2 to 3 ft., \$2.00 each.

Tamarix Savin Juniper (*J. sabina tamariscifolia*). A low, dense trailing plant with grayish green foliage. A fine rock plant. 12 to 15 in. spread, \$2.00 each.

PINE. *Pinus*

Austrian Pine (*P. nigra*). A tree of rapid growth with long dark green foliage. A vigorous and rugged grower even under unfavorable conditions. 2 to 3 ft., \$3.00 each; 3 to 4 ft., \$4.50 each; 4 to 5 ft., \$6.00 each.

Dwarf Mugho Pine (*P. montana mughus*). Foliage dark green; very dwarf in habit; very useful as a border or rock plant. 12 to 15 in., \$1.00 each; 15 to 18 in. spread, \$1.50 each; 18 to 24 in. spread, \$2.00 each.

PINE. *Pinus* (Continued)

Red Pine (*P. resinosa*). A vigorous grower with long, rich green needles. 2 to 3 ft., \$1.50 each; 3 to 4 ft., \$3.00 each; 4 to 5 ft., \$5.00 each; 5 to 6 ft., \$7.50 each.

Scotch Pine (*P. sylvestris*). A tree of rapid growth with short, stiff, bluish green foliage. 2 to 3 ft., \$1.50 each; 3 to 4 ft., \$2.75 each; 4 to 5 ft., \$4.00 each.

White Pine (*P. strobus*). A lofty native tree with soft silvery green foliage. Does well on sandy soil. 2 to 3 ft., \$2.00 each; 3 to 4 ft., \$2.75 each; 4 to 5 ft., \$3.75 each; 5 to 6 ft., \$5.00 each; 6 to 7 ft., \$7.50 each.

RETINOSPORA (Japan Cypress). *Chamaecyparis*

Plume Cypress (*R. plumosa*). Erect branches with side shoots of a plume-like arrangement; graceful, feathery, green foliage. 1½ to 2 ft., \$1.50 each; 2 to 3 ft., \$3.00 each.

Golden Plume Cypress (*R. plumosa aurea*). A golden form of the above. 1½ to 2 ft., \$1.50 each; 2 to 3 ft., \$3.00 each.

Sawara Cypress (*R. pisifera*). An upright, graceful tree with flattened branchlets; foliage green. 1½ to 2 ft., \$1.50 each; 2 to 3 ft., \$3.00 each; 3 to 4 ft., \$4.50 each.

Golden Sawara Cypress (*R. pisifera aurea*). A golden form of the above. 1½ to 2 ft., \$1.75 each; 2 to 3 ft., \$3.00 each.

Thread Cypress (*R. filifera*). The long, thread-like branches are very pendulous; lateral stems of bright green. 18 to 24 in., \$2.00 each; 2 to 3 ft., \$3.00 each; 3 to 4 ft., \$4.50 each.



Dwarf Mugho Pine (*Pinus montana mughus*)



Spreading Juniper (*Juniperus communis*)

SPRUCE. *Picea*

Colorado Green Spruce (*P. pungens*). A stately evergreen of symmetrical habit, having sharp, dull green needles on horizontal branches. 1½ to 2 ft., \$1.50 each; 2 to 3 ft., \$2.50 each; 3 to 4 ft., \$3.00 each; 4 to 4½ ft., \$5.00 each; 5 ft., \$7.00 each; 6 ft., \$8.00 each.

Colorado Blue Spruce (*P. pungens glauca*). The well known Colorado Blue Spruce. 1 to 1½ ft., \$2.00 each; 1½ to 2 ft., \$3.00 each; 2 to 2½ ft., \$5.00 each; 3 ft., \$6.00 each; 3½ ft., \$7.50 each; 4 ft., \$9.00 each; 5 ft., \$10.00 each; 6 ft. \$12.00 each.

Koster's Blue Spruce (*P. pungens kosteri*). The bluest of all the Spruces. 15 to 18 in., \$5.00 each; 18 to 24 in., \$7.00 each; 2 to 2½ ft., \$8.00 each; 2½ to 3 ft., \$10.00 each; 3 to 3½ ft., \$12.50 each; 3½ to 4 ft., \$15.00 each.



Colorado Blue Spruce

SPRUCE. *Picea* (Continued)

Dwarf Alberta Spruce (*P. glauca eonica*). A beautiful, compact cone-shaped evergreen with dense foliage. Dwarf. 15 to 18 in. \$5.00 each; 18 to 24 in., \$6.00 each.

Norway Spruce (*P. excelsa*). A hardy, rapid growing tree with dense, dark green foliage. 1½ to 2 ft., 75c. each; 2 to 3 ft., \$1.00 each; 3 to 4 ft., \$2.00 each; 4 to 5 ft., \$3.50 each; 5 to 6 ft., \$5.00 each.

White Spruce (*P. canadensis*). An upright grower with light silvery green foliage. 1 to 1½ ft., 75c. each; 1½ to 2 ft., \$1.00 each; 2 to 3 ft., \$2.00 each; 3 to 4 ft., \$3.00 each; 4 to 5 ft., \$4.00 each.

Douglas Spruce (*Pseudotsuga douglasi*). A magnificent tree of rapid growth: dark, bluish green foliage. 2 to 3 ft., \$2.50 each; 3 to 4 ft., \$4.00 each; 4 to 5 ft., \$6.00 each; 5 to 6 ft., \$7.50 each.

YEW. *Taxus*

Japanese Yew (*T. cuspidata*). One of the most desirable of the low growing evergreens. The foliage is dark green; spreading habit and very hardy. 12 to 15 in., \$1.75 each; 15 to 18 in., \$2.50 each; 18 to 24 in., \$3.00 each; 2 to 2½ ft., \$5.00 each.

Upright Japanese Yew (*T. cuspidata capitata*). An upright form of the above. 15 to 18 in., \$3.00 each; 18 to 24 in., \$5.00 each.

Improved Japanese Yew (*T. cuspidata intermedia*). The habit of growth is more dense and the foliage darker than the Japanese. 12 to 15 in., \$2.50 each; 15 to 18 in., \$3.50 each; 18 to 24 in., \$5.00 each.

Dwarf Japanese Yew (*T. cuspidata nana brevifolia*). An excellent dwarf variety with very dark green foliage. 12 to 15 in., \$3.25 each; 15 to 18 in., \$4.00 each; 18 to 24 in., \$7.50 each.

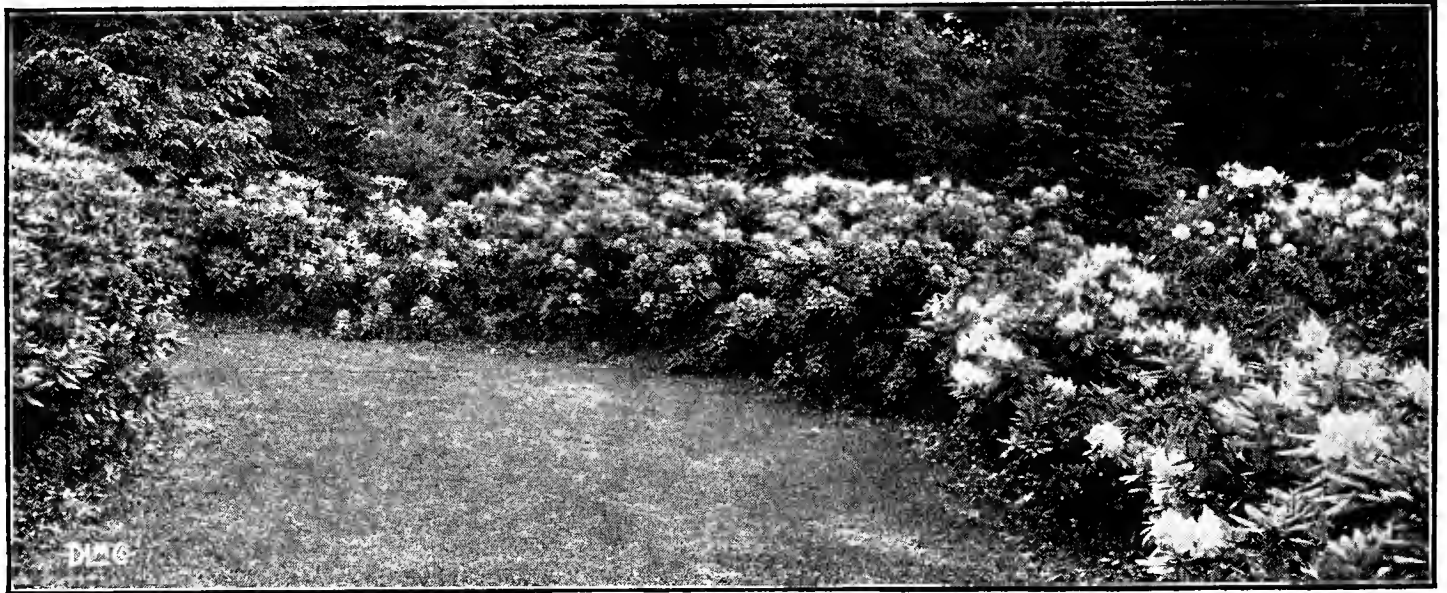

Planting of Rhododendrons

Evergreen Shrubs

These splendid plants hold their rich green foliage all the year round, and in many varieties make a magnificent showing of bloom. Shaded situations are preferred by most of the varieties.

ANDROMEDA (*Pieris floribunda*) (Lily-of-the-valley Shrub). Beautiful, hardy shrub. In early April it is covered with showy spikes of white flowers. 12 to 15 in. \$2.00 each; 15 to 18 in. \$2.50 each.

DAPHNE cneorum (Rose Daphne). A most attractive, dwarf, almost prostrate shrub. In May, and again in August; it bears beautiful flower clusters of a delightful shade of pink. For rock gardens it is very desirable. 6 to 9 in. 75c. each; 9 to 12 in. \$1.00 each; 12 to 15 in. \$1.50 each.

Mountain-laurel (*Kalmia latifolia*)

EUONYMUS radicans. Very hardy, dense-growing trailing vine; dull green leaves, with whitish veins; grows rapidly; self-clinging. 50c. each, \$5.00 per doz., \$40.00 per 100.

radicans variegata. Similar in habit to the above. Foliage green and white. 50c. each, \$5.00 per doz.

vegetus. A pretty, low-trailing evergreen with aerial rootlets which cling to any support. Has round leaves and produces an abundance of showy red fruits with yellow pods. 75c. each, \$7.50 per doz.

LEUCOTHOE (*Andromeda catesbaei*). A valuable shrub for planting under trees and in other shady positions. Flowers are fine white and are borne in long, pendulous racemes. 12 to 15 in. \$1.50 each; 15 to 18 in. \$2.00 each.

MOUNTAIN-LAUREL (*Kalmia latifolia*). Grows 8 ft. high, with broad, glossy green foliage. The rose colored flowers, in large and showy clusters at the ends of the shoots, appear in June. 12 to 15 in. \$1.25 each; 15 to 18 in. \$1.50 each; 18 to 24 in. \$2.00 each; 2 to 2½ ft. \$3.00 each; 2½ to 3 ft. \$4.50 each.

PACHYSANDRA terminalis (Japanese Spurge). The best ground cover under shrubs of all kinds. Grows only 6 in. high, and has dark green foliage. 30c. each, \$3.00 per doz., \$22.50 per 100.

RHODODENDRON carolinianum (Carolina Rhododendron). Leaves rather small, narrow, dark green above, covered with brownish dots beneath; clusters of clear rose pink flowers in May; very hardy. 15 to 18 in. \$2.50 each; 1½ to 2 ft. \$3.00 each.

catawbiense (Catawba Rhododendron). One of the most beautiful native shrubs and the hardiest of all the Rhododendrons. Color, rosy purple. 15 to 18 in. \$3.00 each; 18 to 24 in. \$3.50 each.

maximum (Great Laurel). A well known native of our mountain regions, with great clusters of white or rose pink flowers in June and July. 15 to 18 in. \$2.00 each; 18 to 24 in. \$2.50 each, 2 to 3 ft. \$3.50 each; 3 to 4 ft. \$5.00 each.

YUCCA filamentosa (Adams Needle). Handsome, creamy white flowers, much branched and densely packed with bloom, with swordlike foliage. 40c. each.

Fruit Trees

APPLES

5 to 7 ft., \$1.00 each, \$10.00 per doz.

SUMMER VARIETIES

- Early Harvest.** Yellow, medium size. Aug.
- Red Astrachan.** Red, large. Aug.
- Sweet Bough.** Pale yellow, large. Aug.
- Williams Favorite.** Red, excellent. Aug.
- Yellow Transparent.** Pale yellow, good. Aug.

AUTUMN APPLES

- Duchess.** Yellow, streaked red.
- Fameuse, or Snow.** Crimson. Nov. to Jan.
- Fall Pippin.** Greenish yellow, large. Nov.
- Gravenstein.** Red striped, large. Oct.
- Wealthy.** Deep red, white flesh.

WINTER VARIETIES

- Baldwin.** Red, large.
- Cortland.** A beautiful red; larger than McIntosh and ripening a month later.
- Delicious.** Large, red.
- Hubbardston Nonsuch.** Yellow and red, large.
- King of Tompkins County.** Crimson, large.
- McIntosh Red.** One of the best, red; Nov., Feb.
- Northern Spy.** Yellow and red; large.
- Rhode Island Greening.** Greenish yellow; large.
- Roxbury Russet.** Medium to large. Dec. to June.
- Spitzenburg.** Red, medium, excellent. Dec. to April.
- Talman Sweet.** Yellow, medium size. Nov. to April.

DWARF APPLES

\$1.25 each, \$13.00 per doz.

- Baldwin, Duchess, Gravenstein, McIntosh.**
- Red Astrachan, R. I. Greening, Yellow Transparent.**

CRAB APPLES

\$1.00 each, \$10.00 per doz.

- Hyslop.** Dark crimson; large.
- Transcendent.** Yellow and red striped; large.

CHERRIES

\$1.00 each, \$10.00 per doz.

- Black Tartarian.** Purplish black; large. June.
- Early Richmond.** A preserving variety.
- Gov. Wood.** Yellow and red; large. June.
- Montmorency.** A large, preserving variety.
- Napoleon.** Yellow and red; large. July.
- Windsor.** A large, deep colored variety of good flavor.
- Yellow Spanish.** Pale yellow, red cheek. June.

PEARS

5 to 7 ft., \$1.00 each, \$10.00 per doz.

SUMMER VARIETIES

- Bartlett.** Yellow and large.
- Clapp's Favorite.** Yellowish green, large.

AUTUMN VARIETIES

- Anjou.** Greenish yellow. Nov. to Dec.
- Beurre Bosc.** Russet color; large. \$2.00 each.
- Seckel.** Yellowish russet; small.
- Sheldon.** Yellowish russet; medium size.

WINTER VARIETIES

- Duchess.** Very large, yellow, with a dull red cheek.
- Lawrence.** Yellow and red; medium.

DWARF PEARS

\$1.00 each, \$10.00 per doz.

- Anjou, Bartlett, Duchess, Seckel.**

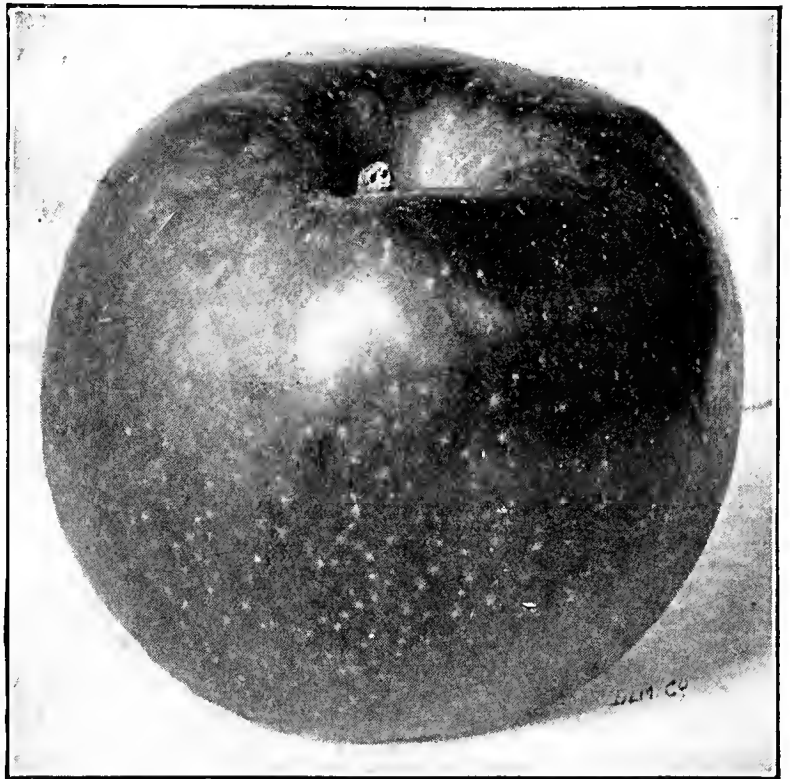

Baldwin Apple

PEACHES

50c. each, \$5.50 per doz.

- Belle of Georgia.** White, red cheek; large, very late.
- Carman.** Pale yellow with red blush. Large and sweet flavor.
- Champion.** Creamy white, red cheeks; large. Aug. 1.
- Crawford's Early.** Yellow and red; large. Aug.
- Crawford's Late.** Yellow and red; large. Sept.
- Elberta.** Large; light yellow. Aug.
- Greensboro.** White with red cheek. Early.
- J. H. Hale.** Large yellow Freestone. Sept.
- Mountain Rose.** Large, red, with white flesh; early.
- Oldmixon Free.** White and red; large. Sept.

PLUMS

Trees, 5 to 7 ft., \$1.00 each, \$10.00 per doz.

- Bradshaw.** A very large, oval; dark violet red; juicy, sweet and good.
- Coe's Golden Drop.** Very large; light yellow; rather firm; rich, sweet and good; adheres to the stone.
- Damson.** Last of September. Small, dark purple; valued for preserving.
- Lombard.** Medium oval; violet red, juicy, pleasant and good; very productive.

JAPAN PLUMS

- Abundance.** Lemon yellow ground, overspread with bright cherry, and a heavy bloom; large.
- Burbank.** Large and beautiful; clear cherry red.

QUINCES

\$1.00 each, \$10.00 per doz.

- Apple, or Orange.** Large, roundish, bright golden yellow; very productive. Early to late.
- Champion.** Large, yellow, very productive and ripening very late.
- Rea's Mammoth.** Large, yellow; one of the best. Early.

Small Fruits

GRAPES

35c. each, except where noted

BLACK

Campbell's Early. Very large and sweet; early. 60c.

Concord. Large, always reliable. Medium.

Moore's Early. Early. **Worden.** Large, early.

RED

Brighton. Large, early.

Catawba. Late.

Delaware. Small, delicious. Late.

WHITE

Green Mountain. One of the best. Early.

Moore's Diamond. Early. **Niagara.** Medium.



Rathbun Blackberry

BLACKBERRIES

\$1.00 per doz., \$7.00 per 100

Eldorado. Extra fine and very hardy; large, sweet berry.

Rathbun. Very large, sweet and delicious.

Snyder. Medium size; very fine. Medium.

RASPBERRIES

\$1.00 per doz., \$7.00 per 100

Columbian. Purple fruit, delicious for table.

Cuthbert. Medium to large, red, sweet.

Golden Queen. Large, yellow; fine quality.

St. Regis Everbearing. Large, bright crimson berries.

Herbert. Large, sweet, bright red.

STRAWBERRIES

The Strawberry will grow in any good garden soil where the ground has been thoroughly prepared. For family use we recommend planting them in double rows, 1 foot apart each way and 5 feet between the double rows, allowing a sufficient number of runners to grow into the wide passage to cover about 1½ feet on each side; all the rest should be pinched off. It is advisable to cover the plants in Winter with litter, which should be removed as soon as the plants commence to grow in Spring.

Layer Plants in Spring, \$3.00 per 100, \$28.00 per 1000, except where noted.

Pot-Grown Plants after Aug. 1

Abington. Strong grower and great yielder. The bright red berries are of very large size, firm and fine flavor. Early to medium.

Arabine. Extra early, very large, bright red of high quality, very robust grower and heavy cropper.

Barrymore. Awarded silver medal and three first premiums by the Massachusetts Horticultural Society, in 1908. A great berry for all purposes. Large size, rich, dark, glossy, crimson color; conical shape; flesh red and quality excellent. Medium.

Big Joe. A magnificent new Strawberry of robust growth and very prolific. The berries are light crimson in color and very large. Medium.

Brandywine. Large, roundish, conical, bright, glossy, crimson berries, firm and solid; excellent quality and fine flavor. Medium.

Commonwealth. Large, glossy crimson berry, of excellent quality, a great cropper and one of the latest.

Gibson. Very large, deep red, fine flavor. Medium.

Glen Mary. Very large, highly colored, firm, and ranks with the best in flavor. Medium to late.

Golden Gate. New seedling, resembles the Marshall and will succeed where the Marshall fails. It produces strictly fancy, firm fruit clear to the end of the season, of a rich, crimson color.

Judith. A large, medium-red, pointed berry; a good market variety; very early.

Marshall. Large rich crimson, fine flavor. One of the most popular sorts. Medium.

Premier. One of the best of the extra early varieties; does well in almost any section; excellent quality; bright red.

Senator Dunlap. Dark red berries of medium size. The flesh is red all through and exceedingly juicy. Early midseason.

Warren. Dark, blood red, extra size, broad and flattened at tips, borne on large clusters. Medium.

EVERBEARING STRAWBERRIES

Mastodon. Truly a Wonderberry, in size, flavor and yield. \$4.00 per 100.

Progressive. The fruit is rich and sweet, a deep red inside and out; of good medium size and quite firm. \$3.50 per 100.

Superb. Perfect blossoms. Enormous crops in June, and in September. It does not fruit on new runners. \$3.50 per 100.

All prices subject to change without notice

Farm, Garden and Lawn Requisites, Tools, Etc.

Asparagus Buncher. Makes bunches of size usually sold in Boston market. \$5.00 each.

Asparagus Knife. Also used as a weeder. 40c. each.

Axes. Warranted steel, Witherell's extra quality, handled. \$2.50 to \$3.50 each.

Bamboo Poles. 20 ft. 65c. each, \$7.00 per doz.

Bands, Rubber. For bunching Asparagus, Celery, Beets, Radishes, etc. Used in place of twine or tape. In 1-lb. boxes, 75c. per lb.

Bars, Crow. Solid cast steel. Per lb. 12c.

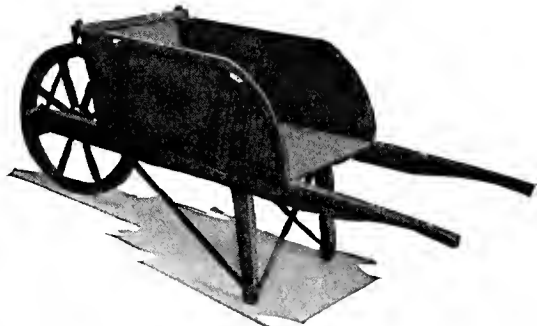

Barrow, New England Garden. This is a strong, well-made barrow; the frame is made from best seasoned timber, nicely painted and striped, it has an eight-spoke, steel axle, wood wheel. We consider it the best garden barrow manufactured. Three sizes, No. 64 medium, \$7.00; No. 65, large, \$8.00; No. 66, extra large, \$9.00.

Barrow, Garden, No. 4. Boys' or ladies'. \$5.00.

Barrow, Greenhouse. Made especially for greenhouse. Long narrow bodies with wood wheel. \$9.00.

Barrow Leaf Rack. Made of galvanized wire, with wood bottom, capacity ten bushels. \$9.00.

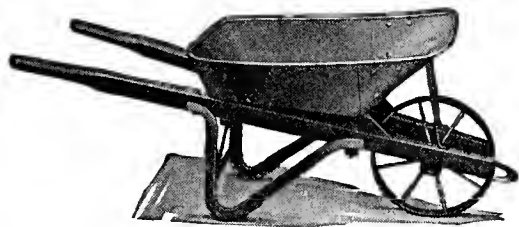

Barrow, Steel Tray Contractors'. For conveying concrete, mortar, sand, gravel, cement, fertilizer, etc. Strongly reinforced.

No. 17B—Capacity 3½ cubic feet.....\$7.00

No. 21 —Capacity 2½ cubic feet..... 5.00

Baskets, Hand Made. Fancy and rustic, lawn, flower, garden, etc. Various styles and sizes. Circular fully describing and illustrating same mailed on request.

Baskets, Tomato or Pansy. Wire handles, also used for fruit as well as plants. 100 1000

3-quart size.....\$4.00 \$35.00

2-quart size..... 3.00 28.00

Baskets, Picking. For gathering fruit or vegetables.

Swing or Stationary Bail. 1 pk. 75c., ½ bus. \$1.00,

3 pks. \$1.25.

Baskets, Shepherd. 1 bus. \$2.50 each; 2 bus. \$4.00 each.

Baskets. For holding leaves. 4 bus. \$4.00 each.

Baskets, Vegetable. Strapped bail. ¼ bus. \$1.00 each;

½ bus. \$1.15 each, ¾ bus. \$1.30 each, 1 bus. \$1.50 each.

Baskets, Wire Hanging. Either round or flat bottom.

6 in. 30c. each; 7 in. 40c. each; 8 in. 50c. each; 10 in.

60c. each; 12 in. 70c. each.

Basswood Poles. 14 ft. long. Used for pruning and tree painting. 65c. each, \$7.00 per doz.

Bellows. Houchin Dry Powder. \$3.00 to \$4.00 each.

Bill Hooks. For heavy pruning. English. \$3.00.

Boxes for Cut Flowers. The following sizes are kept in stock. Others can be furnished promptly.

No.	Length	Width	Depth	Doz.	100
1	18 in.	5 in.	3 in.....	\$1.00	\$6.00
2	21 in.	5 in.	3½ in.....	1.10	6.50
3	24 in.	5 in.	3½ in.....	1.20	7.00
4	30 in.	5 in.	4 in.....	1.30	8.00
5	21 in.	8 in.	5 in.....	1.40	9.00
6	24 in.	8 in.	5 in.....	1.50	10.00
7	28 in.	8 in.	5 in.....	1.75	12.00
8	36 in.	8 in.	5 in.....	2.25	16.00

Corrugated Shipping.

Size	Inches	Each	Doz.
B	24x12x6.....	\$0.50	\$5.00
C	30x12x7.....	.60	6.00
D	36x12x9.....	.70	7.00
E	40x15x9.....	.80	9.00
F	48x15x9.....	1.00	11.00

Brooms. For use in greenhouses, stables, etc. Two sizes, \$1.00 and \$1.25 each.

Brooms. Rattan and broom corn mixed. \$1.50 each.



Brooms. Rattan, push or street, 16 in. \$1.00 each.

Brooms and Rakes, Bamboo. Japanese.

Very useful on lawns, driveways and golf courses.

Prices: Brooms 75c. each; Rakes, 18 in. 60c. each; 24-in. 75c. each.

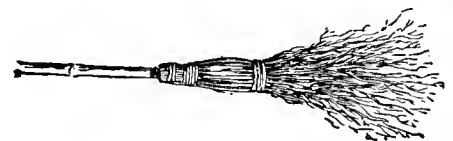

Brushes, Dandy. Imperial. \$1.00 each.

Brushes. For applying creosote to destroy eggs of the gypsy moth. 50c. each, \$5.00 per doz.

Brushes, Pole. Complete with bracket to attach to pole for using creosote in high places. \$1.25 each.

Brushes and Can. For creosote. The can fastens to the belt, leaving the hands free. \$1.00 each.

Bull Rings. Copper. Manufactured from the best material only; will not injure the bull's nose. 40c. each.

Bull Rings. Cannon metal. Extra heavy. \$1.50 each.

Burlap. For putting around trees to trap gypsy moths. 8 in. wide, 7c. per yard; 100 yards \$6.00. 40 in. wide, 15c. per yard; piece about 100 yards, 14c. per yard.

Burning Brands. For marking tools, etc. Six letters or less, \$5.00; each additional letter, \$1.00.

Bush Hooks. Strapped-eye handle. \$2.00.

Carnation Support, Excelsior. Heavy galvanized wire in two sizes, 13 in. \$3.00 per 100; 20 in. \$3.50 per 100.

One of each length makes a complete plant support.

Chains. Best quality steel. Ajax breast, 32 in. \$2.50 per pair; Cow Ties, 75c. each. Tie out chains, 20 feet, \$1.00 each; 30 feet, \$1.50 each. Long, Heavy Trace, \$3.00 per pair; Heavy Whiffletree, \$1.50 per pair.

Coal Tar. For covering scars made by removing large limbs from trees. \$1.00 per gal., \$4.00 per 5 gals.

Cotton Wadding. In large sheets, for protecting plants and flowers from frost. 10c. each, \$1.00 per doz., \$6.00 per 100.

FLOWER LOVER'S BUDDIES

- Four tools, consisting of
- One Garden Trowel
- One Spedy Hand Weeder
- One Hand Garden Fork
- One Hand Garden Hoe

All high grade material—Set complete, \$2.25

FARM, GARDEN AND LAWN REQUISITES, TOOLS, ETC.—Continued

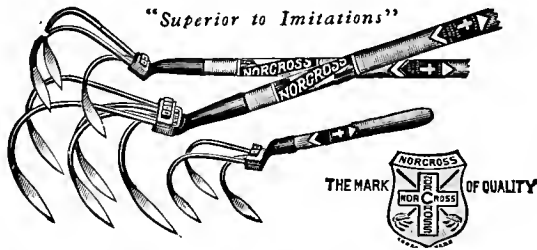

Cultivator, The Norcross Hand Garden. Does the work easier and faster than any wheel hoc. Each
 5 prong, 4 ft. handle.....\$1.00
 3 prong, 4 ft. handle..... .75
 3 prong, 9 in. handle..... .40

Cultivator, The New Norcross Garden Grower. For description, see page 100. Each
 No. 8, 8 in.....\$6.00
 No. 10, 10 in..... 7.00

Celery Wrappers. Best quality parchment paper, printed. 12x15 in. Pkt. 1000 sheets, \$3.50.

Dibbles. Steel points, wooden or iron handle. 75c. each.

Ferrules and Caps and Mal. D's for Handles. 5c., 15c. and 25c. each.

Edging Knife, American. \$1.25.

Edging Knife, English. \$2.00 each. Handles, extra, 50c. each.

Electric Tape. For mending hose, etc. 40c. per coil.

Flower Pot Saucers, Thermoid Rubber. Breakproof—leakproof. Made of a durable and sturdy rubber compound with cleated bottom to allow water to drain through the flower pot. Can be used on polished surfaces without scratching the finish. Each Doz.

No. 1—For 4 in. pot.....	\$0.15	\$1.50
No. 2—For 4½ or 5 in. pot.....	.20	2.00
No. 3—For 6 in. pot.....	.25	2.50
No. 4—For 6½ or 7 in. pot.....	.30	3.00
No. 4A—For 7½ or 8 in. pot.....	.35	3.50
No. 5—For 9 in. pot.....	.40	4.50
No. 6—For 10 in. pot.....	.60	6.50
No. 7—For 12 in. pot.....	.85	9.00

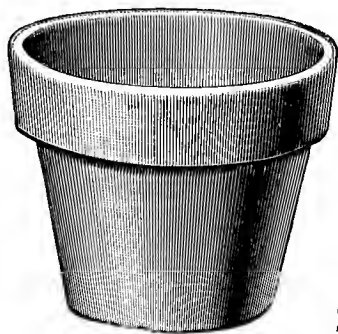

Hews Flower Pot, Standard
 Measurement from inside to inside. Width and depth equal.

Inches	Doz.	100
2.....	\$0.25	\$1.50
2½.....	.30	2.00
3.....	.35	2.50
3½.....	.40	3.00
4.....	.50	3.75
4½.....	.75	5.00
5.....	.90	6.75
6.....	1.40	10.00
7.....	2.25	17.00
8.....	3.25	24.00
9.....	4.50	35.00
10.....	6.50	50.00
11.....	10.00	75.00
12.....	13.00	100.00

Flower Pot Hanger, Krich's Perfect. No. 1 will fit from 3½ to 5 in. pots, 40c. per doz. No. 2 will fit from 5 to 8 in. pots, 45c. per doz. No. 3 will fit from 8 to 12 in. pots, 50c. per doz.

Bulbs and Seed Pans, Round

Size	Each	Doz.	Size	Each	Doz.
6 in.....	\$0.15	\$1.40	10 in.....	\$0.65	\$6.50
7 in.....	.20	2.25	12 in.....	1.25	13.00
8 in.....	.30	3.25	14 in.....	1.75	20.00
9 in.....	.50	4.50	16 in.....	3.25	36.00

Flower Pots, Neponset Black. Made of tough waterproof paper, eliminating breakage. Superior to any other pot on the market for the actual growing and transplanting of plants. Not less than one case at 1000 price.

Inches	In case	Doz.	100	1000
2¼.....	1000.....	\$0.15	\$0.60	\$5.00
2½.....	1000.....	.20	.75	5.50
3.....	1000.....	.25	1.00	6.50
3½.....	1000.....	.30	1.25	8.75
4.....	500.....	.40	1.50	10.00
5.....	500.....	.50	2.00	13.50
6.....	500.....	.60	2.50	17.50

Flower Pots, Neponset Red. For storage, transplanting, and shipping. The paper from which these pots are made is specially treated and water-resistant. Not less than one case at 1000 price.

Inches	In case	Doz.	100	1000
2¼.....	1000.....	\$0.10	\$0.50	\$4.25
2½.....	1000.....	.15	.60	4.75
3.....	1000.....	.20	.75	5.75
3½.....	1000.....	.25	1.00	7.50
4.....	500.....	.30	1.25	9.00
5.....	500.....	.40	1.50	12.00
6.....	500.....	.50	2.00	16.00

Flower Pot Saucers, Standard.

Inches	Doz.	100	Inches	Doz.	100
3½.....	\$0.35	\$2.50	9.....	\$1.90	\$14.00
4.....	.50	3.25	10.....	2.35	17.00
5.....	.60	3.75	11.....	2.75	21.00
6.....	.85	5.75	12.....	3.75	26.00
7.....	1.10	8.00	13.....	4.25	35.00
8.....	1.50	11.00	14.....	5.00	40.00

Flower Vases, Galvanized Iron. Strong, light, durable, made of good material with heavy hoop at base of can to reinforce bottom of vase. These vases are finished in a moss green enamel baked on.

No.	Top Diam.	Bot. Diam.	Hght.	Each	Doz.
5	7¾ in.	5½ in.	11 in.....	\$1.00	\$11.00
6	7¾ in.	5½ in.	17 in.....	1.25	14.00
7	8 in.	6¼ in.	11 in.....	1.00	11.00
8	9 in.	7¾ in.	12 in.....	1.25	14.00
9	9 in.	7¾ in.	17 in.....	1.50	16.00
10	6⅝ in.	5 in.	14 in.....	1.00	11.00
11	5½ in.	4¼ in.	15 in.....	1.00	11.00
12	5 in.	4 in.	9½ in.....	.90	10.00

Floral Tools, "American." These tools are not toys, but serviceable tools, of high grade material, well made and finished. Per Set

No. 4, P. S. F. 4-Piece Set: Shovel, Rake, Hoe, and Spading Fork.....	\$3.00
No. 3 P. F. 3-Piece Set: Shovel, Rake and Hoe...	2.00
Extra Rakes for above set.....	Each .50
Extra Spading Forks.....	Each 1.00
Extra Hoes.....	Each .75
Extra Floral Shovels.....	Each .75

Forks, Ensilage. 8 tine, D handle, strapped..... 2.50

Forks, Hand. For transplanting, American..... .40

Forks, Hand. For transplanting, English..... 1.25

Forks, Hay. 4 to 6 ft., bent handles..... \$1.25 to 2.00

Forks, Manure. 4 tine, mal. D handle, strapped.. 1.75

Forks, Manure. 5 tine, mal. D handle, strapped.. 2.00

Forks, Manure. 6 tine, mal. D handle, strapped.. 2.25

Forks, Manure. 4 tine, wood D handle, strapped.. 2.00

Forks, Manure. 5 tine, wood D handle, strapped.. 2.25

FARM, GARDEN AND LAWN REQUISITES, TOOLS, ETC.—Continued

- Forks, Manure.** 6 tine, wood D handle, strapped. . \$2.50
- Forks, Manure.** 4 tine, long handled, strapped. . 1.75
- Forks, Manure.** 5 tine, long handled, strapped. . 2.00
- Forks, Manure.** 6 tine, long handled, strapped. . 2.25
- Forks, Spading.** 4 tine, long handled, strapped. . 1.75
- Forks, Spading.** 4 tine, mal. D handle, strapped. . 1.75
- Forks, Spading.** 4 tine, wood D handle, strapped. . 2.00
- Forks, Spading.** 5 tine, mal. D handle, strapped. . 2.25
- Forks, Stone.** 8 tine, mal. D handle, strapped. . 2.25
- Garden Lines, Braided.** 100 ft. \$1.00, 200 ft. \$1.75.
- Garden Line Reels.** Small \$1.50, large \$2.00 each.
- Glass Cutter.** 25c. and 50c. each.
- Glaziers' Points (Perfection).** Will stop glass from slipping. Made of steel wire galvanized. Double point. Per box of 1000, No. 2, 75c.; No. 2½, 85c.
- Glaziers' Points (Zinc City).** Made of zinc. Will not rust. In three sizes, ⅝, ¾ and ⅞ in. long. Each size, 65c. per lb.
- Gloves, Gardeners' Pruning.** With gauntlets. \$2.00 per pair; without gauntlets, \$1.50 per pair.
- Grafting Knife, or Chisel.** All steel, \$1.25 each.
- Grafting Wax.** ¼ lb. 20c., ½ lb. 30c., lb. 50c.
- Grass Hooks, or Sickles.** English, No. 2, 75c. each; No. 4, \$1.00 each; American, 50c. and 75c. each.
- Grindstones, "Nova Scotia."** Mounted on selected hardwood frames. Sizes vary from 20 in. to 30 in. in diameter. Prices from \$20.00 to \$30.00 each.
- Grindstone Fixtures.** \$2.50 to \$4.00 per set.
- Grindstones, Unmounted.** 15c. per lb.
- Hammer, Nail.** Adze eye, bell face. \$1.00 to \$1.50 each.
- Hammer, Stone.** Solid cast steel. 25c. per lb.
- Hammer, Stone Striking.** Solid cast steel. 20c. per lb.
- Hatchet, Shingling.** Cast steel. \$1.00 each.
- Hatchet, Barrel.** \$1.00 to \$1.50 each.
- Hatchet, Axe Pattern.** \$1.25 and \$1.50 each.
- Handles, Axe.** Extra quality hickory. 75c. each.
- Handles, Hammer.** Extra quality hickory. 50c. each.
- Handles, Pick.** Extra quality hickory. 75c. each.
- Handles, Hay Fork.** Extra quality ash. 50c. to \$1.00 each.
- Handles, Hoe.** Extra quality ash. 35c. each.
- Handles, Manure Fork.** 75c. to \$1.25 each.
- Handles, Shovel and Spade.** 75c. each.
- Handles, Rake.** 50c. each.
- Hoes, Nurserymen's Two-pronged Steel.** \$2.25 each.
- Hoes, Boothby-toothed.** \$1.50 each.
- Hoes, Humphrey.** \$1.00 each.
- Hoes, American Scuffle, Handled.** 8 in. \$1.25 each.
- Hoes, English or Dutch Scuffle.** 3 in., 75c.; 4 in., 80c.; 5 in., 85c.; 6 in., 90c.; 7 in., \$1.00; 8 in., \$1.10; 9 in., \$1.25 each. Handled, extra 50c.
- Hoes, Market Gardeners' Slide or Scuffle (Arlington).** Handled, 4 in. to 9 in. \$3.00 each.
- Hoes, Garden, Socket Draw.** 8 in. \$1.15 each.
- Hoes, Meadow.** 9 in., \$1.25; 10 in., \$1.35 each.
- Hoes, Warren.** \$1.25 each.
- Hoes, Mortar or Street.** 10 in., \$1.25 each.
- Hoes, Ladies' and Boys'.** 75c. and \$1.00 each.
- Hoes, Onion.** \$1.15 each.
- Hoes, Weeding.** 6 tooth. \$1.00 each.

Hose Connection, Shut-off. For use with any nozzle that has no shut-off where one is desired. \$1.00 each.

Hose Connection, Siamese. \$1.00 each.

Hose Coupler, "Rain King." Instantly connects hose to faucet, hose to sprinkler, hose to nozzle, or hose to hose. Don't bother screwing hose connections together. Just snap them on instantly with this new invention. 60c. each.

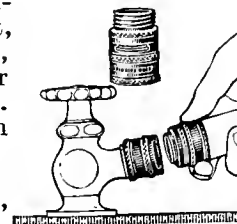

Hose Couplings. ½, ⅝ and ¾ in., per set, 25c. each.

Hose Mender (Hudson's Pattern). Wizard sheet brass tubes. Substantial yet light in weight. Does not obstruct water way of hose. ½, ⅝ and ¾ in. 5c. each, 50c. per doz. Wires, 25c. per doz., \$1.75 per 100.

Hose Mender, Cooper's. Made of heavy brass, requires no wires or pliers to adjust it. 10c. each, \$1.00 per doz.

Hose Menders, Perfect Clinching. In one piece, doing the work of the mender tube and two clamps ordinarily used. ½, ⅝ and ¾ in., 10c. each, \$1.00 per doz.

Hose Clamps. Made of galvanized steel with screw adjustment. ½ and ¾ in., 5c. each, 50c. per doz.

Hose Reducers. For connecting ½ in. and ¾ in. hose couplings with Bordeaux or Vermorel nozzles. 35c. each.

Hose Nozzle, Bordeaux Spray. \$1.00 each; with reducer for ¾ in. hose, \$1.35.

Hose Nozzle, New Boston. Will throw a coarse or fine spray or a large or small stream. 75c. each.

Hose Nozzle, "Rain King," The New Little Wonder. Finger tip control. Outsprinkles all other makes with solid stream and intermediate or misty sprays. Just a touch of the finger on the control gives you any desired spray from a solid stream to cloudlike mist. Made of all brass, leakproof and wearproof. The most efficient, easiest handling hose nozzle made and will outlast all others. 85c. each.



Hose Nozzle, Stott's. Specially recommended for greenhouse spraying. Throws a forcible side spray. Single spray, \$2.00 each; double spray, \$3.00 each.

Hose Nozzle, Rose Spray. For greenhouse, flower garden, hotbed, etc. Heavy brass, 3 in. face, \$1.00 each; 4 in. face, \$1.25 each. Light brass, 3 in., 75c. each; 4 in., \$1.00 each. "Greenhouse," with coarse and fine 4 in. spray, \$2.50 each.

Hose Reels. All metal, strong, substantial hose reels for gardens or lawns. Made with high wheels, almost indestructible. No. 10, holding 100 ft. \$4.50 each. No. 20, holding 150 ft. \$5.00 each.

Hose, Rubber Garden, "Dreadnought Brand." A braided hose made of the best materials. Does not kink. We offer this in 25 and 50 ft. lengths coupled; also in continuous lengths of 500 ft. ½ in. at 18c. per ft.; ¾ in. at 20c. per ft.

Hose Nozzle Holder. Any hose nozzle can be attached. Automatic and entirely of brass. By a pressure of the fingers on the handle, the spray is turned on, by releasing the pressure the spray automatically shuts off; unlike most shut offs, it only takes one hand to manipulate it. \$1.50 each.

FARM, GARDEN AND LAWN REQUISITES, TOOLS, ETC.—Continued

Hose, Washers, Rubber. For ½ in. and ¾ in. hose. Doz. 10c., ¼ lb. 35c., lb. \$1.00.

Knives, Budding and Pruning. Imported. In various styles, \$1.50 to \$5.00 each.

Labels, Copper. Made of copper and copper wired. Indestructible and always legible. No. 1, 3½x¾ in., \$2.25 per 100; No. 2, 5x1½ in., \$2.75 per 100.

Labels, Simplex Weatherproof. Made of celluloid with mica cover. (Price includes copper wires for attaching).

	Doz.	100
No. 1—3x½ in.....	\$0.50	\$3.00
No. 2—4x¾ in.....	.75	5.00
No. 3—5x1 in.....	1.00	7.00

Labels, Wood. For plants and trees.

	Plain or Painted		Painted
	100	1000	
4 in. Pot Label.....	\$0.30	\$1.80	\$2.20
5 in. Pot Label.....	.35	2.20	2.50
6 in. Pot Label.....	.40	2.50	3.00
8 in. Garden Label.....	.90	6.50	8.00
10 in. Garden Label.....	1.15	8.25	10.50
12 in. Garden Label.....	1.50	10.50	13.00
3½ in. Tree Label.....	.30	1.50	2.00
3½ in. Tree, iron wired....	.35	2.00	2.50
3½ in. Tree, copper wired...	.40	2.50	3.00

Label, The Perfect Garden. Unobtrusive, serviceable and convenient, sets close to ground. Ordinary lead pencil markings on this label are permanent without any protection, above or under the soil. Economical. Markings can be completely erased with pencil eraser and label marked again at any time. Ample horizontal marking space.

	Each
Standard size, 5 in. long (marking space 2x1¼ in.)	\$0.10
Rock Garden size, 4 in. long (marking space, 1¾x7⁄8 in.)	.08

Manure Hooks. Long handle, 4 tine, \$1.25; 5 tine, \$1.35; 6 tine, \$1.50.

Mats, Hotbed. Made by hand of the best rye straw. Size 6x6, \$3.25.

Mats, Hotbed. 76x76 in. Covers two sash, made of heavy cotton or duck, filled and quilted. \$5.00 each.

Mattocks. Short cutter on grub hoe. 3 lbs. \$1.00 each.

Mattocks, Long Cutter. Extra quality. \$1.25 each.

Mattocks, Pick. Extra quality. \$1.25 each.

Melon Nets. For supporting Melons in the greenhouse. 35c. each, \$3.50 per doz.

Mole Traps, "Little Giant." \$1.25 each.

Oilers. With spring bottom. 25c. to 75c. each.

Oil, Harvester. For mowers, reapers, etc. Gal. \$1.25.

Pails, Stable. Heavy galvanized iron. 10 qt. 40c., 12 qt. 50c., 14 qt. 60c.

Paper, Green Waxed. Sheets 12x18 in., lb. 50c.; ream, about 3 lbs., \$1.25. Sheets, 24x36 in., lb. 50c.; ream, about 11 lbs. \$4.00.

Paper, White Tissue. Sheets 20x30 in., lb. 40c.; ream, about 7 lbs., \$2.00. Sheets 24x36 in., lb. 40c.; ream, about 9½ lbs., \$3.00.

Paper, White Waxed. Sheets 12x18 in., lb. 50c.; ream, about 5 lbs., \$2.00. Sheets 24x36 in., lb. 50c.; ream, about 12 lbs. \$4.00.

Paper, White Wrapping. Sheets 24x36 in., lb. 20c.; ream, about 40 lbs., 18c. per lb.

Pencils, Indelible Label. With point protector. Black or blue, 20c. each.

Picks, Contractors. Best refined iron with steel points. \$1.25 each.

Plant Protecting Cloth for Hotbeds. Valuable for covering hotbeds and frames, instead of glass. Medium grade. Per yd. 25c., by the piece (about 60 yds.) 24c.

Plant Tubs, Cedar. For ferns, palms and other large plants. Made of thick cedar, nicely painted green. Drop handles. No. 2 and larger have hook handles. Outside measurements:

	No.	across top	Diam. outside	Height	Each
	1	28 in.	22 in....	\$17.00	
	2	26 in.	20 in....	14.00	
	3	24 in.	18½ in....	9.00	
	4	22 in.	17 in....	7.25	
	5	20 in.	16 in....	6.25	
	6	18½ in.	15 in....	5.00	
	7	17 in.	14 in....	4.25	
	8	16 in.	13 in....	3.75	
	9	14 in.	12 in....	3.00	
	10	12 in.	9½ in....	2.50	
	11	10½ in.	9 in....	2.25	
	12	9½ in.	8 in....	2.00	

Tubs, Richmond Style. Strongly made of selected white cedar and bound with electric welded wire; painted green. Without handles.

No.	Diam. inside	Each	No.	Diam. inside	Each
6	11 in.....	\$1.00	10	15 in.....	\$2.00
7	12 in.....	1.25	11	16 in.....	2.25
8	13 in.....	1.50	12	17 in.....	2.50
9	14 in.....	1.75	13	18 in.....	3.00

Plant Sprinklers, Scollay's Rubber. \$1.50 each.

Post Hole Digger. 4 ft. Atlas. \$2.00 each.

Potato Hooks. Steel shank, 5 tine, \$1.25; 6 tine, \$1.35.

Potato Digging Fork. 6 tine \$2.00.

Pruner, Standard Tree. Operated by a lever, to which the blade is connected by iron rod, 6-ft. pole, \$1.75; 8-ft. pole, \$2.00; 10-ft. pole, \$2.25; 12-ft. pole, \$2.50; 14-ft. pole, \$2.75; 16-ft. pole, \$3.00 each. Extra blades, 25c. each.

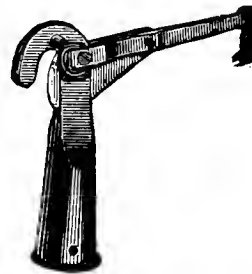

Pruner, Telephone Tree. Without pole (See cut). A pole of any length to suit requirements can be inserted in the socket. It is operated by a cord tied in the end of the lever. \$1.60 each. Extra blades. 25c. each. Extra springs. 25c. each.

Paragon No. 3 Sprayer, Wheelbarrow Type. Twelve gallon capacity. Has special design of pump, which is never submerged in the liquid; all working parts of brass; very large brass air chamber, insuring 300 lbs. working pressure, with great ease of operation. 16 square inches of strainer at bottom of suction pipe automatically cleaned by galvanized agitator. Cannot clog. Not even necessary to strain any solution sprayed.



The Paragon sprays insecticides, disinfectants, white-wash, etc. Equipment furnished: 10 ft. special high pressure spray hose, 7½ ft. spray pipe shut-off valve, three spray nozzles. Price complete, with either two-

wheel or single wheel truck, \$22.50. Price, without truck, \$19.00.

FARM, GARDEN AND LAWN REQUISITES, TOOLS, ETC.—Continued

THE HUSKY SPRAYER

A new compression sprayer. Advanced in design and construction. A general purpose spraying outfit for spraying plants, shrubbery, and trees with liquid insecticides and fungicides, and for spraying liquid disinfectants and deodorizers in stables, poultry houses, etc. The Husky Sprayer is also suitable for spraying whitewash and water mixed paints or wood stain. Husky Sprayers embody quality in the use of the best materials, in combination with high grade workmanship. Advanced design provides durability, convenience and ease of operation. Equipped completely with strap, 30 in. high pressure hose, valve, 12 in. extension pipe, and 45 degree spray nozzle with clean-out plug.



- No. 1401—2½ gal. steel tank. Price, \$4.50 each.
- No. 1402—2½ gal. copper tank. Price \$7.00 each.
- No. 1403—4 gal. steel tank. Price, \$5.00 each.
- No. 1404—4 gal. copper tank. Price, \$8.50 each.

BROWN'S AUTO SPRAY NO. 1

An excellent machine for all-round use. It efficiently handles all disinfectants, insecticides, fly sprays, floor oils, etc., and is just the thing for use around the home, in the garden, in the orchard and for spraying field crops. The corrugated tank and drain-dry features are distinctive Brown features. The corrugations not only prevent the sprayer from slipping from the hands, but greatly reinforce the tank. Pump is of one piece brass tubing with all-metal check valve. Equipped completely with strap, hose, automatic shut-off nozzle and 24 in. extension.



- No. 1B, 4-gal. brass tank. Price, \$9.00 each.
- No. 1D, 4-gal. galvanized tank. Price, \$6.00 each.

BROWN'S SIREN OUTFIT

Consists of the No. 5 Auto Spray Double-acting Pump, a 5-gallon solidly constructed copper bearing galvanized steel sheet tank. It is adapted for spraying orchards, field crops, vines, shrubs, whitewashing, fire fighting, etc. Price complete, \$9.00. Pump only, \$4.50.

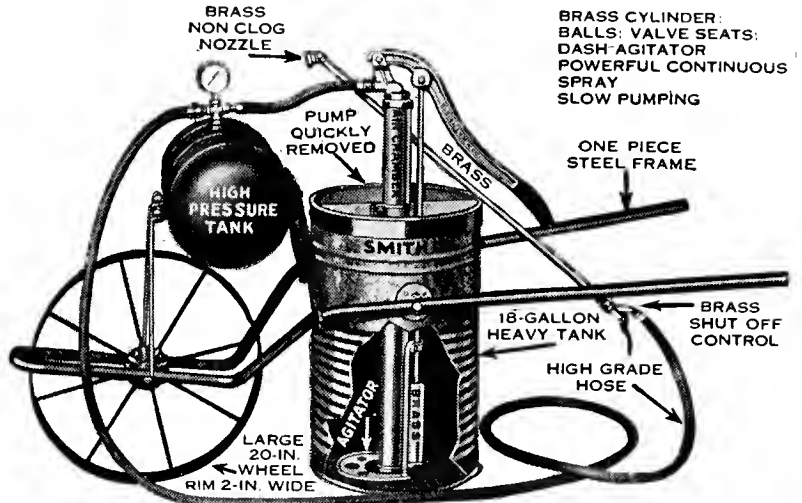
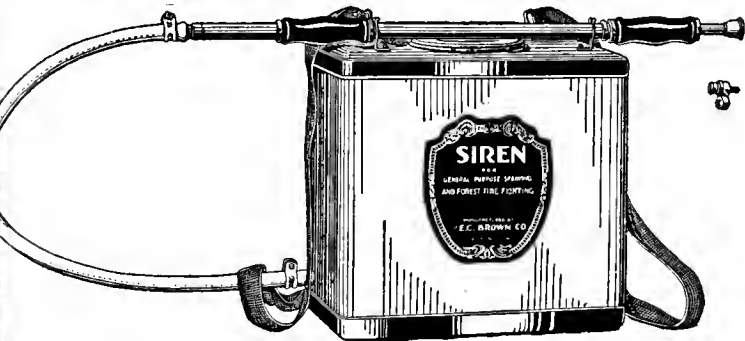

SMITH WHEELBARROW SPRAYERS With or Without High Pressure Tank

For use in spraying orchards, garden truck, vineyards, field crops and lawns; also for spraying whitewash, cold water paints, disinfectants and for general spraying purposes. Exceptionally well built for long, hard service. All working parts are brass. The High Pressure Air Tank, guaranteed for 250 lbs. pressure, will spray for a considerable length of time after the pressure has been-pumped up. The extra large wheel permits easy wheeling. The pump is very powerful. It requires no priming, and is quickly removed from the tank, when the outfit may be used for wheeling water and slops about.

Bucket Tank—Extra heavy copper bearing, galvanized steel sheet. Tanks are heavily corrugated and reinforced, giving extra strength. Capacity, 18 gals.

Extension Pipe—Heavy brass, length 3 ft. For elevating spray.

No. 60PG—Complete, with High Pressure Tank and Galvanized Bucket. Price, \$32.00.

No. 60G—Complete, with Galvanized Bucket, but without High Pressure Tank. Price, \$22.00.



BROWN'S AUTO SPRAY NO. 26

This glass tank, continuous atomizer is the newest and most practical sprayer of its kind. Operator can always see the exact amount of liquid in the reservoir, and wide mouth opening makes easy filling and cleaning, supplies on both up and down stroke, and maintains a constant mist, which can be delivered at any angle with very little effort.

No. 26A—All tin, 1 qt. Price, 75c. each.

No. 26BG—Tin cylinder, glass container, 1 qt. Price, \$1.00 each. Pt. size, 75c. each.

BROWN'S AUTO SPRAY NO. 60

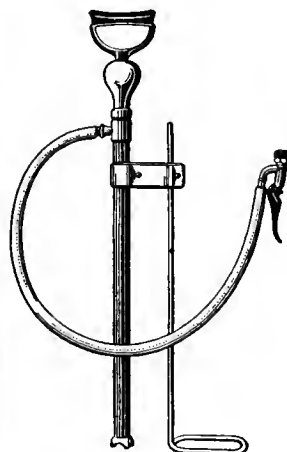

This bucket pump is double acting, throwing a continuous stream of spray. The small diameter of the air chamber makes possible a great amount of pressure and the storage chamber in the handles insures a continuous discharge. All working parts are of brass and will not rust or corrode. Especially adapted for spraying truck gardens, field crops and orchards.

Price, \$5.00 each.

FARM, GARDEN AND LAWN REQUISITES, TOOLS, ETC.—Continued

Pump, Kinney's Atomizer. For use in greenhouses to distribute liquid fertilizer or to mix or temper hot and cold water under pressure. \$3.00 each.

Putty Bulb. For glazing greenhouse sash. \$1.50 each.

Putty, Twemlow's Old English Glazing. A superior article for bedding glass in sash or filling cracks or seams in roof joints, etc. 1 gal., 3 gal. and 5 gal. containers at \$3.75 per gal.

Raffia. The best material for tying. Soft, pliable and strong. 35c. per lb., 10 lbs., 30c. per lb.

Raffia, Green. For tying plants, etc. \$1.25 per pkg.

Rakes, Gibbs' Lawn. All steel; reversible, strong and light. 24 teeth, \$1.00 each.

Rakes, Bamboo Broom. Fan shape, 18 in. 60c. and 24 in. 75c. each.

Rakes, Brume. Steel, fan-shaped rake; used as a broom; strong and durable. \$1.00 each.

Rakes, Dandelion. Keeps lawn free from Dandelion heads, dead grass, etc. \$1.00 each.

Rakes, Hay, Wood. Extra quality, three bow. \$1.00 each.

Rakes, Lawn, Wood. Extra quality. Three bow. \$1.25 each.

Rakes, Steel. Heavy, for roadwork. 14 teeth, \$1.25; 16 teeth, \$1.50.

Rakes, Steel Garden. Long teeth. 10 teeth, 90c.; 12 teeth, \$1.00; 14 teeth, \$1.10; 16 teeth, \$1.15; 18 teeth, \$1.25.

Rakes, Steel Lawn. Short teeth. 12 teeth, \$1.15; 14 teeth, \$1.25; 16 teeth, \$1.35; 18 teeth, \$1.50.

Rope, Columbian Tape-marked. Pure manila. "The guaranteed rope." In various sizes. Market price.

Sash, Hotbed. Well made from thoroughly seasoned lumber and glazed with double thick glass. Frame 1 3/4 in., 3x6 ft., \$6.50 each. Crating extra at cost.

Saws, Cross Cut. Two man, filed and set, ready for use. 5 ft., \$4.00 each. Handles, 75c. per pair.

Saws, Cross Cut, One Man. With supplementary handles. 3 ft., \$3.50; 3 1/2 ft., \$4.00 each.

Saws, Pole Pruning. \$2.00 to \$2.50.

Saws, Pruning. Single and double edge. Extra refined spring steel. 18 in. \$1.75, 20 in. \$2.00 each.

Saws, Wood (Buck). No. 45 complete, with famous "McKenney Triple Cut" blades. \$2.00 each.

Scissors, Flower. For cutting and holding flowers. 7 in., \$1.75 each.

Scissors, Grape or Vine. For thinning the bunch. Nickel-plated. 6 in., \$1.50; 7 in., \$1.75 each.

Scops, Coal. Extra quality. No. 2, \$1.75; No. 3, \$2.00; No. 4, \$2.25; No. 5, \$2.50; No. 6, \$2.75 each.

Scythes, "Witherell's" Finest Cutlery Steel. Fully warranted. \$1.75 each.

Scythes, Broad English or Lawn. \$2.50 each.

Scythes, Heavy Bush. \$2.00 each.

Scythes, Weed or Bramble. \$2.00 each.

Scythe Snaths. \$1.50 each; bush, \$1.75 each.

Scythe Stones, Carborundum. 40c. each.

Scythe Stones, English Round. Talacre. 40c. each.

Scythe Stones, "Manchester." 20c. each.

Seed Sower, "Cahoon." Best machine for sowing broadcast, grass seed, oats, barley, etc. \$5.00 each.

Seeder, Wheelbarrow Grass. This seeder is arranged to sow all kinds of grass seed, etc., in any quantity, from 6 to 40 qts. to acre with 14 ft. hopper. \$16.00 each.

Silkline (Smilax Thread). Spools 40c. each, box of 8 spools, \$3.00.

Shears, "Grasnip." A practical all-around shear for grass, vines, light shrubbery, etc. 6 in. cutlery steel blades, \$1.00 each.

Shears, Branch or Lopping. Clyde improved draw cut, the best and strongest shear made. Cuts without crushing.

No. 1—22 in. handle.....\$3.25
 No. 2—24 in. handle..... 3.50
 No. 3—Disston Bull-Dog Double Cut Jaw..... 3.50

Shears, Grass Border. Long handle, 8 in. blade, \$5.00; 9 in., \$5.50; 10 in., \$6.00 each. Long handle wheel, 9 in. blade, \$6.00; 10 in., \$6.50 each. Extra handles, \$1.50 pair.

Shears, Grass or Sheep. \$1.00. English extra quality. \$2.00 each.

Shears, Hedge or Grass. English pruning notch. 8 in. blade, \$3.00; 9 in., \$3.50; 10 in., \$4.00 each. Extra handles, \$1.00 pair.

Shears, Lawn or Grass. Long handle, 9 in., \$5.50 each.

Shears, Dahlia or Root. Imported. \$4.00 each.

Shears, Ladies' Hedge. American, 6 in., \$2.00. English, \$2.50 each.

Shears, Ladies' Pruning. 6 in. rose, \$1.75 each.

Shears, German Pruning. Nickel-plated, lock nut, volute spring. 8 in., \$2.50; 9 in., \$3.00; 10 in., \$3.50 each.

Shears, Pruning, French. With wheel spring, polished, 7 in., \$1.75; 8 in., \$2.00; 9 in., \$2.25; 10 in., \$2.50. Extra springs, 50c. each.

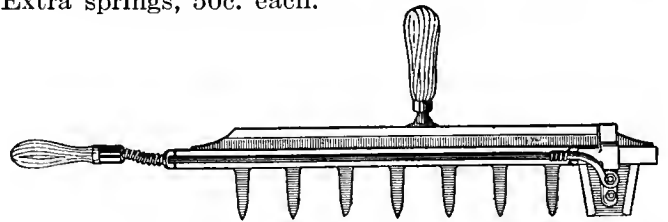

Shears, "Cyclone" Hedge Trimmer. Faster cutting, more uniform trimming, easy to operate. Eliminates slow, tiresome trimming of hedges and assures even and uniform results. Frequent trimming is made possible due to the speed and ease of operation, resulting in beautifying and strengthening the hedge. The Cyclone weighs only 3 lbs. and is designed to be self-balanced, allowing for straight, level trimming. Made both right and left handed. \$6.00 each.

Shovels, Snow. Wood. Malleable iron tip. \$1.25 each.

Shovels, Snow. Steel, either long or D handle. \$1.00 each.

Shovels, Superior Steel. Round or square pointed D or long handle. No. 2, \$2.25 each; No. 3, \$2.50 each.

Shovels, Market Gardeners. Lightweight for banking Celery, etc. Long handle. \$1.50 each.

Sod Lifter. Useful for cutting under sod as it is being rolled. English, \$8.00. American, \$4.00.

Spades, Superior Steel. Extra quality. Either D or long handle. No. 2, \$2.25 each.

Stake Fasteners. Galvanized, rustproof wire. Hold the stakes and cross wires firmly.

Eureka. Small and light. Pkg. of 1000, \$3.00.

Everlasting. Heavy and strong. Pkg. of 1000, \$4.50.

Wire Plant Ties. Pkg. of 1000, \$2.25.

Stakes, Japanese Cane, Green. Small and inconspicuous, but strong and useful for plants.

		Doz.		100		1000	
1	ft...	\$0.10	\$0.50	\$3.00	3	ft....	\$0.20 \$1.00 \$7.00
1 1/2	ft...	.12	.60	4.00	3 1/2	ft....	.25 1.15 8.00
2	ft...	.15	.75	5.00	4	ft....	.30 1.25 10.00
2 1/2	ft...	.18	.85	6.00	5	ft....	.35 1.75 14.00
6 ft., plain, 40c. per doz.,		\$2.00 per 100,		\$15.00 per 1000			
8 ft., plain, 50c. per doz.,		\$3.00 per 100,		\$26.00 per 1000			

Stakes, Japanese Bamboo Garden. Very strong and durable, 5/8 to 3/4 in. in diameter. 4 ft., 50c. per doz., \$4.00 per 100; 6 ft., 75c. per doz., \$5.00 per 100; 8 ft., \$1.00 per doz., \$6.00 per 100.

Support, "Adjusto" Plant. A small, unbreakable and practical support. Adjustable to any height for Tomatoes, Roses, Hydrangeas, Dahlias, etc. Made of hard wood, protected by a coat of green paint and heavy spring wire, also painted green. Stakes 7/8 in. square, diameter of wires, 13 in.

	Each	Doz.
3 ft. height.....	\$0.25	\$2.50
4 ft. height.....	.30	3.00
5 ft. height.....	.35	3.75
6 ft. height.....	.40	4.50

Extra 13 in. wire loops (for use on the taller stakes and plants), 15c. each.

FARM, GARDEN AND LAWN REQUISITES, TOOLS, ETC.—Continued

Stakes, Garden, Painted Green. For house, greenhouse and conservatory.

		Light Round Stakes			
Ft.	Doz.	100	Ft.	Doz.	100
1½	\$0.30	\$2.25	3½	\$1.25	\$8.50
2	.50	3.50	4	1.50	11.00
2½	.70	5.00	5	2.25	16.00
3	1.00	7.00			

		Heavy Round Stakes			
Ft.	Doz.	100	Ft.	Doz.	100
3	\$1.75	\$12.00	5	\$2.50	\$18.00
4	2.25	16.00	6	3.00	22.00

		Square Stakes			
Ft.	Doz.	100	Ft.	Doz.	100
1½	\$0.25	\$1.50	4	\$1.25	\$10.00
2	.35	2.50	5	2.00	14.00
2½	.50	3.50	6	2.25	16.00
3	.75	6.00	Ex. heavy 4	2.00	14.00
3½	1.00	8.00	Ex. heavy 5	2.50	18.00
			Ex. heavy 6	3.00	22.00

Stakes, Square, Unpainted. Hardwood. 100 1000
 28 inches long.....\$0.75 \$5.00
 36 inches long..... 1.00 7.00
 48 inches long..... 1.25 9.00

Sticks, Match. Pine, 5-32 inch thick. Green, 40c. per 100, \$3.00 per 1000.

Styptic, Thomson's (Imported). To prevent the bleeding of grape vines. Small bottle \$1.50, large \$2.00.

Tamper. Dirt and sod, high grade. 8x8 base. \$2.00 each.

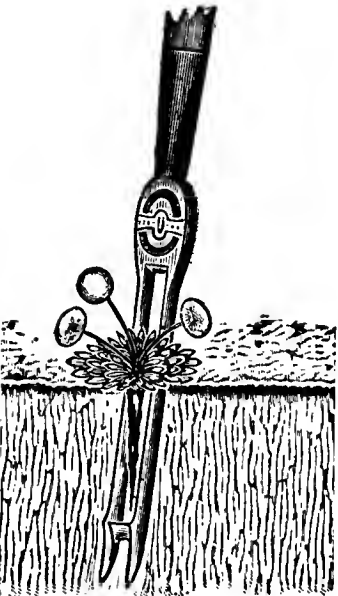

Tape Lines, Pocket size, linen and steel. Nickel plated case, 3 ft. and 5 ft., 60c. to \$1.00 each.

Tape Lines, "Lufkin." Cotton, linen, metallic and steel, 25, 50 and 100 ft., 75c. to \$10.00 each.

Thermometers, Wilder's. Japanned tin case, convex scale. 6 in., 75c.; 8 in., \$1.00; 10 in., \$1.25.

Thermometers, Wilder's. Japanned tin case, heavy, 8 in., \$1.40; 10 in., \$1.50; 12 in., \$1.75.

Thermometers, Wilder's Hotbed. Boxwood, brass-tipped; \$3.50 each.

Tinfoil. For bouquets, etc. 30c. per lb.; green, 50c. per lb.

Tree Scrapers. \$1.25 each.

The New Weed Puller. Out-U-Kum. Guaranteed to remove the root along with the weed. A slight push and a pull does the trick. Price 65c. each.

Twine, Green Linen. For Smilax, 25c. per tube.

Twine, Green Cotton. 15c. per ball, \$1.50 per doz.

Twine, Hard. "For tying parcels," Heavy, medium and light. 40c. per ball, \$4.50 per doz.

Twine, Soft. 20c. per ball, \$2.25 per doz.

Twine, Tarred Marline. Twisted. In 5-lb. and 10-lb. balls. Each 55c. per lb.

Twine, Tarred Yarn (Lath yarn). Excellent for tying shrubs, etc. 30c. per lb.

Twine, White Cotton. 15c. per ball, \$1.50 per doz.

Twine, Yacht Marline. In ½-lb. balls, 50c. each.

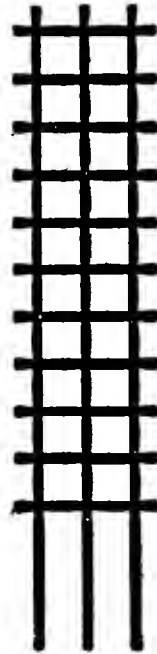

Lattice

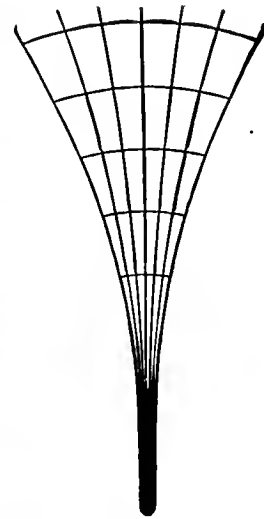

Fan

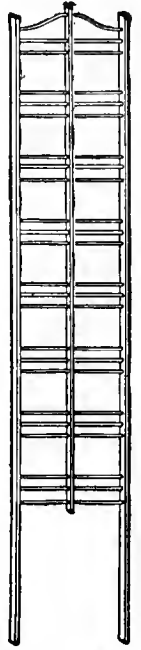

Veranda

TRELLISES

Not carried in stock, but can be shipped promptly from factory. If crating is required in shipment, it will be charged at cost.

Trellis, Tomato. Two hoop; 20c. each, \$2.25 per doz.
Trellis, Tomato, Handy Vine. Made of wood and wire. 35c. each, \$3.50 per doz.

Trellis, Fan.					
Height	Each	Doz.	Height	Each	Doz.
1½ ft.	\$0.35	\$3.50	4 ft.	\$1.65	\$18.00
2 ft.	.50	5.00	5 ft.	2.00	22.00
2½ ft.	.65	7.00	6 ft.	2.25	25.00
3 ft.	1.00	11.00	7 ft.	2.75	30.00
3½ ft.	1.25	14.00	8 ft.	3.00	34.00

Trellis, Veranda. Made of wood and painted dark green, and especially adapted to outdoor use for high climbing vines and roses.

High	Wide	Each	Doz.	High	Wide	Each	Doz.
5 ft.	18 in.	\$1.75	\$20.00	9 ft.	18 in.	\$3.25	\$36.00
6 ft.	18 in.	2.25	24.00	10 ft.	20 in.	3.50	40.00
6 ft.	28 in.	3.00	32.00	10 ft.	31 in.	4.75	54.00
7 ft.	18 in.	2.50	28.00	11 ft.	20 in.	4.00	46.00
8 ft.	18 in.	3.00	32.00	12 ft.	20 in.	4.25	48.00
8 ft.	28 in.	3.75	42.00	12 ft.	36 in.	5.50	64.00

Trellis, Lattice. Made of wood and painted dark green. This style is made to satisfy the increasing demand for a plain yet substantial support which is in harmony with the tendency toward severe lines in architecture. Made in only one width, thus being adaptable around windows and doors, as it can be cut into any desired length.

High	Wide	Each	Doz.	High	Wide	Each	Doz.
6 ft.	18 in.	\$2.25	\$24.00	10 ft.	18 in.	\$3.50	\$40.00
7 ft.	18 in.	2.50	28.00	11 ft.	18 in.	4.00	46.00
8 ft.	18 in.	3.00	32.00	12 ft.	18 in.	4.25	48.00
9 ft.	18 in.	3.25	36.00				

Trowels, Garden, English Genuine. Extra heavy, 6 in., 75c.; 7 in., \$1.00.

Trowels, Transplanting. 6 in. 20c.; 7 in. 25c.

Trowels, Pointing. 4½ in. 50c. each.

Trowels, Flat, Steel. Best steel, 7 in. \$1.75 each.

Trowels, Garden. Extra forged steel. Solid steel blade and shank. 6 in. 65c.; 7 in. 75c. each.

Truck and Leaf Rack. An extremely useful combination, with 2½-in. tires, \$28.00; 3½ in. tires, \$30.00.

Truck and Water Barrel with 2½-in. tires, \$24.00; 3½-in. tires, \$26.00.

Truck and Hand Cart Box with 2½-in. tires, \$22.00; 3½-in. tires, \$24.00.

Extra Barrels with Trunnions, \$8.00; extra trunnions, \$1.00 a pair.

Leaf Rack only, \$12.00; **Hand Cart Box** only, \$5.00.

FARM, GARDEN AND LAWN REQUISITES, TOOLS, ETC.—Continued

Watering Pots. For house use; made of tin painted green and have long spouts. 2 qts. \$1.25.

Watering Pots, English. An ideal pot for watering seedlings, cuttings, etc. 3 qt. \$6.00, 4 qt. \$7.00, 6 qt. \$8.00, 8 qt. \$9.00, 10 qt. \$10.00 each.



English Pattern

Watering Pots, Galvanized Iron.
The best watering pot made, for strength, durability and neatness. Made from best quality iron; the top and back handles riveted on; an iron band on the bottom; the spout riveted, and a brace around it riveted to the body, and galvanized after it is made. A coarse and fine copper-faced rose with each pot. Extra rose 75c. Each

4 qts., spout 18 in. long.....	\$5.00
6 qts., spout 21 in. long.....	5.50
8 qts., spout 23 in. long.....	6.00
10 qts., spout 25 in. long.....	6.50
12 qts., spout 25 in. long.....	7.00
16 qts., spout 25 in. long.....	8.00

Watering Pots, French. Made of galvanized iron; oval in shape, with brass handle and long spout; one fine and one coarse copper-faced rose with each. 6 qt. \$6.00, 8 qt. \$6.50, 10 qt. \$7.00, 12 qt. \$7.50 each.

Weeders, Baby Warren Hoe. 50c. each.

Weeder, Magic. Hand, 3-tine, 18 in. handle, 25c. each; 36-in. handle, 40c. each; 4-tine, 42 in. handle, 75c. each.

Weeders, Onion. Triangle-shaped, 8 in. handle, 3 in. blade, 40c. each; 4 ft. handle, 3 in. blade, 75c. each.

Weeder, Three-pronged. 50c. each.

Weeder, Excelsior. 20c. each.

Weeder, Hazeltine. Steel blade, with wooden handle. 30c. each.

Wedges. Truckee pattern, solid cast steel. 12c. per lb.

Whiffletrees. Selected ash. \$1.00 to \$1.50.

Wire. Annealed galvanized. No. 14, \$1.50; No. 16, \$1.75; No. 18, \$2.00; No. 20, \$2.25 per stone of 12 lbs., in coils.

Wrenches, Monkey. Knife handle. 6 in., \$1.00 each; 8 in., \$1.25 each; 10 in., \$1.50 each; 12 in., \$2.00 each; 15 in., \$2.50 each.

Wrenches, Stillson. Length when opened, 6 in., 65c. each; 8 in., 75c. each; 10 in., \$1.00 each; 14 in., \$1.25 each; 18 in., \$1.75 each; 24 in., \$2.50 each.

SPRAYERS AND DUSTERS

Sprayers or Dusters, Smith's Hand Powder. Various sizes and styles. Price, 75c. to \$3.50.



Sprayer (Banner) Compressed Air. Considered by many the best of all sprayers. Has features found in no other pump of similar make. 4 gallon capacity. Complete as illustrated. With brass tank \$9.00. With galvanized tank, \$6.00.

Testimonial
Hill Acres,
Littleton, N. H.
April 18, 1929

Thomas J. Grey Co.,
16 South Market St.,
Boston, Mass.

Gentlemen: Your Banner Sprayer is the best I have ever used. A wonderful sprayer for both greenhouse or outside. The only sprayer that uses the spray to the last drop.

Yours very truly,
W. W. GALLAGHER,
Gardener to J. R. Morron

Soap Sprayer, Barrie's. Made of solid bronze, heavily nickel plated. Soap is placed in the bowl, the sprayer attached to the faucet and the hose to the sprayer. Water entering the bowl agitates the soap, giving a mild insecticide through the hose, while spraying, never injures the plants and is excellent for destroying green fly, etc., in greenhouse and garden. \$7.00 each.

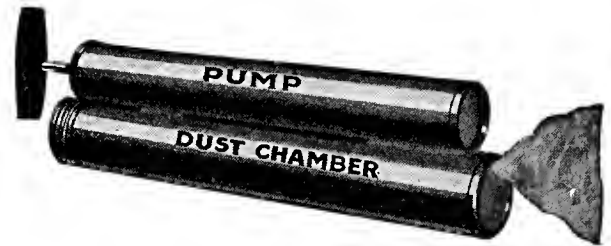
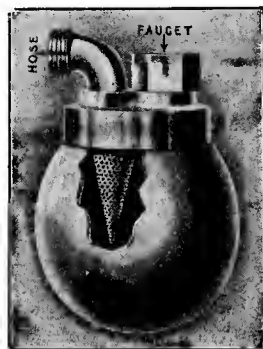

The Double Barrel Duster. For spraying all dry insecticides. Considered the best hand duster on the market. 75c. each.

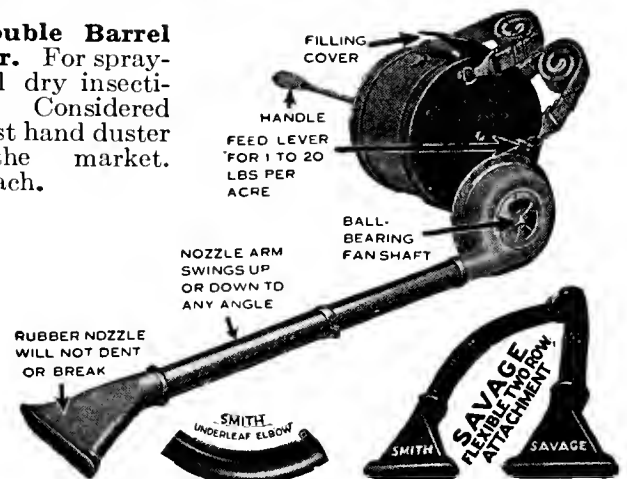

"Savage Duster." Handles everything in powdered form; a high grade, well-built duster made to stand long, hard service. Highly adapted for spraying garden, vegetables, shrubbery, plants, etc. It is free running and easy cranking, has no brushes or wipers. Bronze and steel gears packed in grease, sealed-in gear case; never requires any attention, fan shaft runs on ball bearings. Under-leaf elbow for dusting underside of vines, connects between pipe and nozzle is furnished without extra cost. Price, complete, \$20.00. Two-row attachment connects to dust pipe for dusting two rows with one passing, furnished complete with two rubber nozzles. Price \$3.50.

SINCE 1867
COLDWELL

LAWN MOWERS

HAND—HORSE—MOTOR

CUB

21 inch cut. Capacity, two to three acres per day

SIXTEEN SPECIAL FEATURES

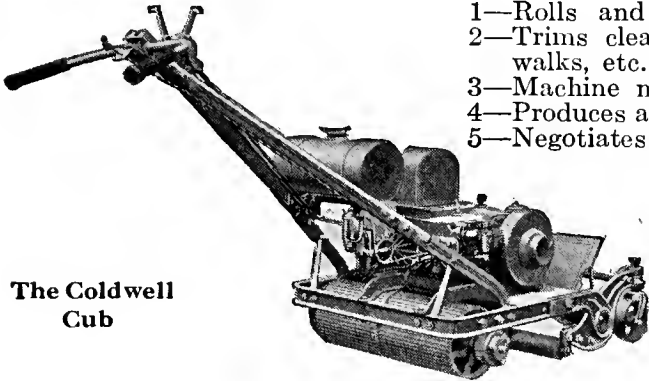

The Coldwell
Cub

- 1—Rolls and mows simultaneously.
- 2—Trims clean around trees, shrubbery, along walks, etc.
- 3—Machine may be used for rolling only.
- 4—Produces a smooth, velvety turf.
- 5—Negotiates grades with ease.
- 6—Simple and economical to operate.
- 7—Extremely flexible for trimming.
- 8—Full width, two-section drive roller.
- 9—Timken tapered roller bearings.
- 10—Three speed control.

- 11—Simple, powerful four cycle water cooled motor.
- 12—Engine automatically lubricated.
- 13—Alemite-Zerk force-feed lubrication.
- 14—Clutches and transmission entirely enclosed.
- 15—Spring loaded clutches require no adjusting and release automatically.
- 16—Entire machine, including the motor, designed and built by Coldwell.

Weight net, 260 lbs. Price, \$195.00 F.O.B. Factory

THE NEW TWIN CYLINDER LINE

25 inch and 30 inch cut

Suitable for lawns of from four to eight acres, also for baseball parks and athletic fields. Extreme flexibility for trimming and for terrace work. Equipped with two cylinder, four cycle water cooled motor, which provides an abundance of reserve power. Is free from vibration and noise and will develop maximum power continuously in hottest weather without overheating. Full width, two-section drive roller with differential between the rollers to prevent marring and to make turning easy. Riding sulky for the operator, and grass catcher may be had as extra equipment.

“L TWIN”—25 inch cut, four to six acres per day. Weight net, 362 lbs. Price, \$350.00 F.O.B. Factory.

This model may also be furnished with two 20-inch auxiliary gang units, which more than double the cutting capacity. These units may be attached or detached in a moment.

“L TWIN” WITH GANG—60-inch cut, ten to twelve acres per day. Price, \$410.00 F.O.B. Factory.

“TWIN 30”—30 inch cut, six to eight acres per day. Weight net, 420 lbs. Price, \$400.00 F.O.B. Factory

SPECIFICATIONS

Motor—Twin cylinder, 4 cycle.

Horse Power—5 h.p., S. A. E. rating.

Ignition—Bosch high tension magneto.

Carburetor—Tillotson, automobile type.

Lubrication—Force feed lubrication, with pump.

Bearings—Crank shaft and transmission shaft carried on roller bearings.

Cooling—Water cooled with radiator and fan.

Transmission—Self adjusting, automobile type cone clutches, roller chain drive.

Speed—Governor control maintains constant speed and may be adjusted to three speed positions—low, normal and high.

Cutting Unit—Full floating, demountable. 5 blade revolving cutter. All blades oil tempered.

Height of Cut— $\frac{3}{8}$ to 2 inches.

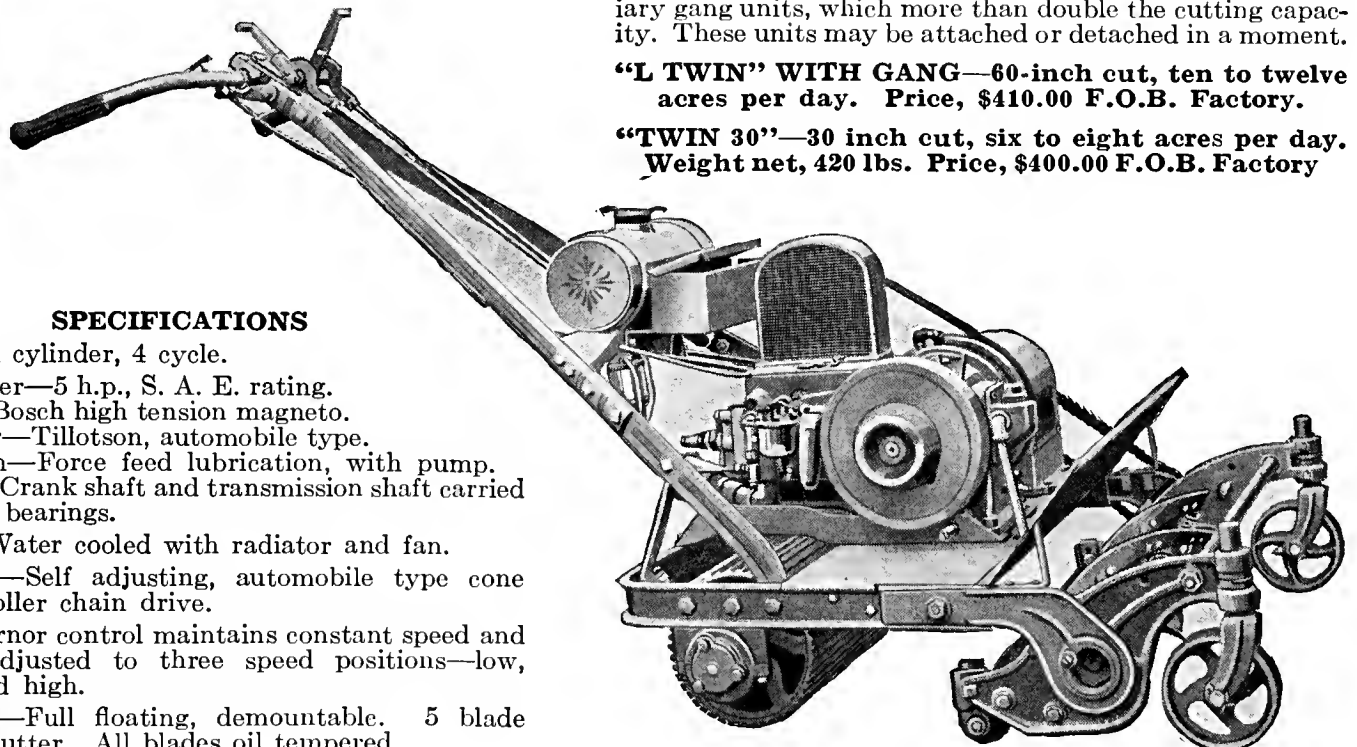

The New Twin Cylinder Line

Owing to limited amount of space we cannot fully describe these machines in our catalog, but will gladly mail a descriptive circular upon request.

LAWN MOWERS—Continued

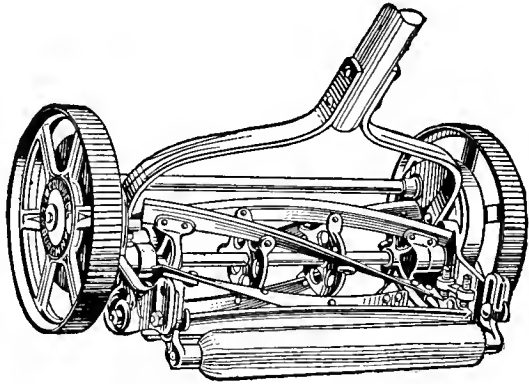

COLDWELL IMPERIAL. 5-blade, high wheel, equipped with improved Norma-Hoffman deep groove, self-aligning, annular ball bearing which is packed in grease with a felt washer and metal seal so as to keep out dirt and foreign matter, and prevent the lubrication from leaking out. This bearing will operate successfully over a period of years without further lubrication or without adjustment. Considered best mower on the market for use in cemeteries, parks, and private estates, where they are expected to do heavy work. Three sizes: 16 in., \$18.00 each; 18 in., \$20.00 each; 20 in., \$22.00 each.

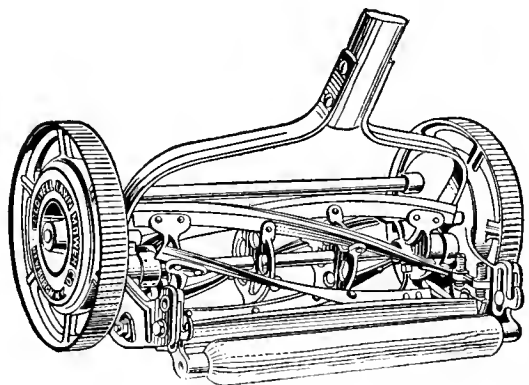

COLDWELL AMBASSADOR. 5-blade, high wheel, equipped with the Norma-Hoffman ball bearings, same as in the Imperial. High grade, medium weight machine at a medium price. A light running, well balanced machine, considered the best 5-blade lawn mower ever built, for the price asked. Coldwell quality throughout. Three sizes: 14 in., \$13.00 each; 16 in., \$14.00 each; 18 in., \$15.00 each.

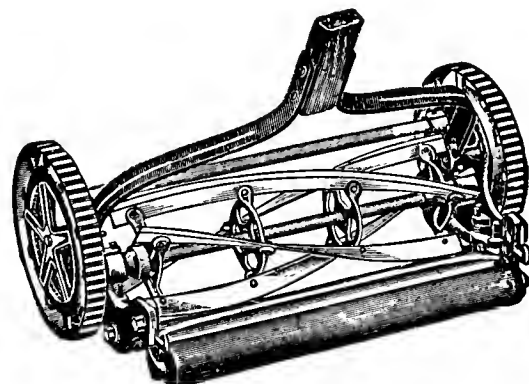

COLDWELL CRUSADER (BALL BEARING). A light-weight, 4-blade mower, designed to meet the demand for a machine of lighter construction at a moderate price. 14 in., \$6.50 each; 16 in., \$7.00 each; 18 in., \$7.50 each.

**OHIO REVERSIBLE PUSH-PULL LAWN MOWER.**

An entirely new principle in lawn mower design. It cuts when you push; it cuts when you pull. It is a forward type cutting lawn mower with flexible ground bar and reel hung in front of center, instead of rear. It will cut close to any object. Can be pulled instead of pushed by reversing handle. With handle reversed, it is specially adapted for terrace cutting or for trimming under bushes, without injury to foliage. Can be adjusted in a fraction of a second to cut grass extremely high or very low. It has 10 in. drive wheel and 5-blade revolving cutter. 16 in., \$20.00 each; 18 in., \$22.00 each.

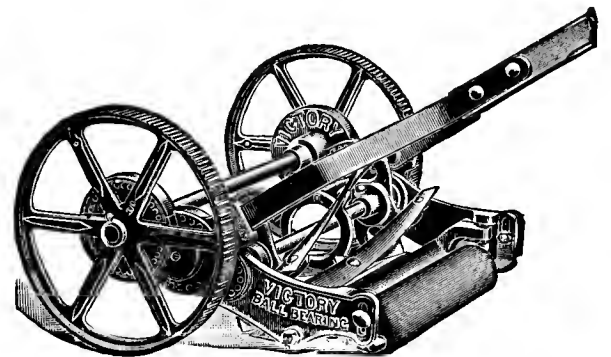

VICTORY BALL-BEARING LAWN MOWER. 10 in. wheel, 4-bladed reel, construction light; easily run and almost silent. 14 in. \$14.00, 16 in. \$16.00, 18 in. \$18.00, 20 in. \$20.00.

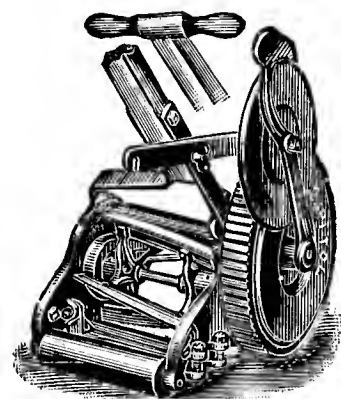

THE "CAPITOL" TRIMMER AND EDGING MACHINE. It does what no other machine can do and what lawn mowers leave undone. It trims and edges the lawn in the quickest possible time. The greatest labor saving gardener's tool on the market. Price, \$10.00.

LAWN MOWERS—Continued

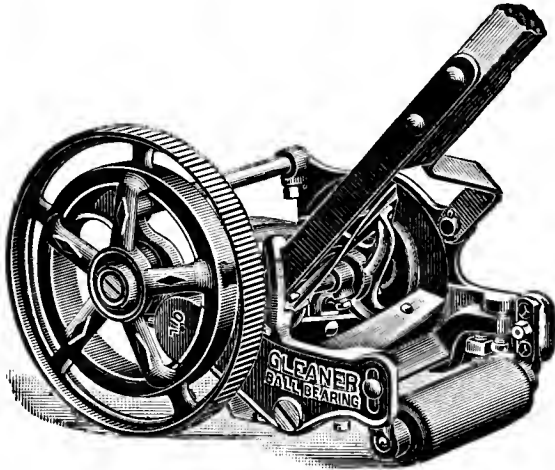

TOWNSEND'S "GLEANER" BALL BEARING. Strong, light and powerful. We warrant it the best trimmer on the market. Only $\frac{1}{8}$ in. of metal between ends of blades and any obstruction to be cut around. 9-in. wheel, 4 blades. Width of cut 8 in., \$8.00 each; 10 in., \$9.00 each.

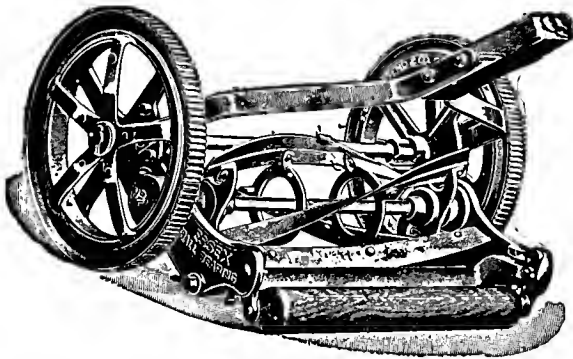

ESSEX LAWN MOWERS, BALL-BEARING. We submit this mower as the highest type of a double gear grass cutting machine. The 11-in. drive wheels make it the easiest running mower in the world. It is made with a reel or wiper of over 6 in. in diameter (4 blades) which enables the user to cut much higher grass than can be cut by the ordinary mower. 14 in. \$14.00, 16 in. \$16.00, 18 in. \$18.00, 20 in. \$20.00.

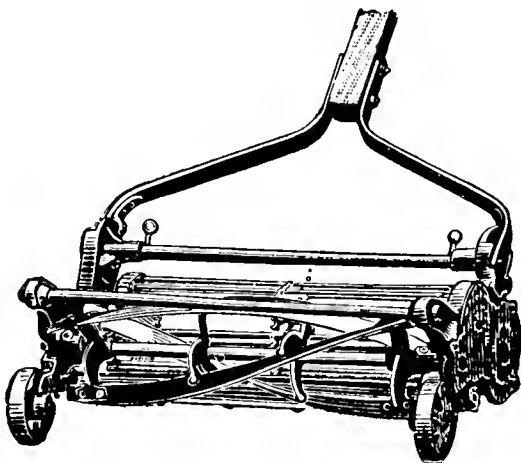

THE EASY. The perfect border mower. Particularly adapted for borders, mounds, terraces, trimming banks. Specifications: Four revolving blades, self-adjusting ball bearings, lipped edge, crucible steel knife, large hollow steel drum, full width support, triple gear drive, two small pilot wheels, detachable handle. 12 in. \$18.00, 14 in. \$20.00, 16 in. \$22.00.

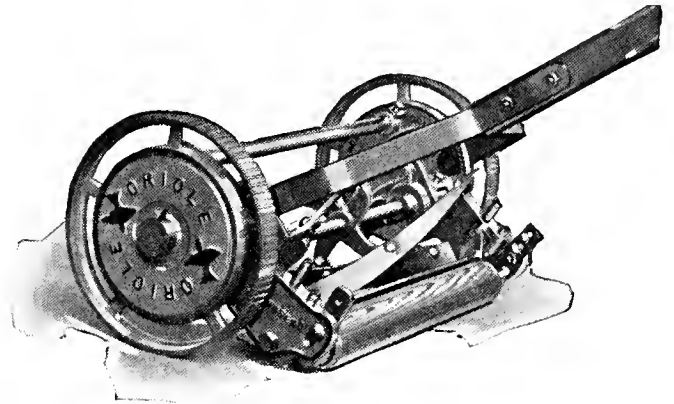

ORIOLE BALL-BEARING LAWN MOWER. This is a high-grade, lightweight, easy running mower. Made especially for bankings and terraces. It has four oil-tempered blades, 8-in. closed type drive wheels and is made of the same quality material as the higher price mowers. Made in two sizes. 12 in. \$7.00, 14 in. \$8.00.

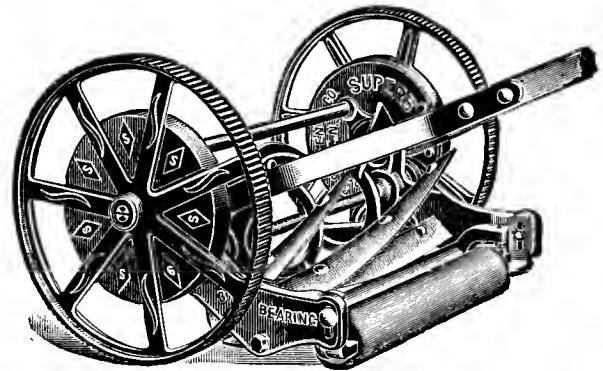

TOWNSEND'S SUPERB BALL-BEARING LAWN MOWER. The highest wheel (12-inch), easiest running, large, hand lawn mower in the world. Built to meet the most exacting requirements in all localities. Quiet in action, easy of adjustment, and does excellent work. Has 5 blades. 18 in. \$20.00, 20 in. \$22.00.

GRASS CATCHERS. Will fit any style of lawn mower. 14 in. and 16 in. \$1.50 each, 18 in. and 20 in. \$2.00 each.

Calling Your Attention to Our
LAWN MOWER SERVICE DEPARTMENT

This department, which is not new but which we have featured for many years, is located in our building, and operated by skilled mechanics, who thoroughly understand this line of work.

With its improved facilities for resharpening, repairing, and adjusting hand, horse, and motor mowers, we solicit your patronage, and suggest that you be very careful with whom you trust your mowers for sharpening and adjusting. To insure seasonable delivery, early shipments are suggested. Please note what you wish especially done to your mower, on the tag or by letter. In cases where this is omitted, we will sharpen same and put in good order. Please remove handles, when convenient, before shipping. Special tags, which you will find convenient in sending your mower, will be mailed on request.

Farm and Garden Tools and Implements

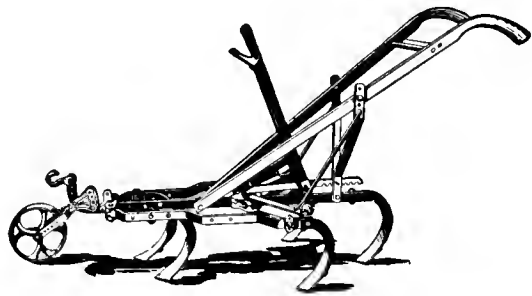

CULTIVATOR, McCORMICK-DEERING

McCormick-Deering 1-horse cultivators can be supplied in 5-, 7-, and 9-shovel and 14-tooth, with a variety of special equipment that adapts them to the needs of those sections where the work is done with one horse. For the cultivation of all farm and garden crops, they cannot, so far as quality of work is concerned, be beaten by any other type of cultivator. We would call particular attention to the superior form of construction by which the cultivator may be varied from the narrowest to the widest position with one motion and with no change of bolts, and when closed up does not get on dead center or become difficult to open. Prices on application.

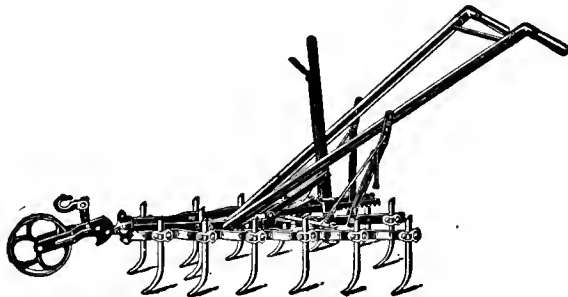

CULTIVATOR, McCORMICK-DEERING, SPIKE-TOOTH

A strongly built cultivator. Teeth clipped rigidly to bars and adjustable to three angles of penetration. Especially adapted to pulverize the soil and leave it smooth and level. The teeth are reversible and the pitch can be quickly changed forward or back by simply loosening one bolt at each tooth. Expanding lever, 14 teeth and wheel. Price of same \$10.00.

NEW MODEL CENTENNIAL

The "New Model Centennial" Horse-Hoe, Cultivator and Coverer combined, has long been recognized as an implement of unusual merit. The simplicity and fewness of parts required for changing it over to suit the various kinds of work to which it is adapted, and its unique and very efficient Expansion Device are among the reasons for its popularity.

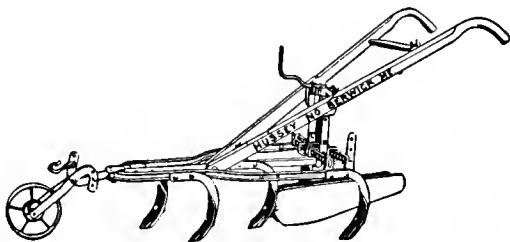

- No. 8.** Has 8 one-inch points, long wings and expander. Price, \$18.00.
- No. 1.** Has 5 three-inch points, long wings and expander. Price, \$15.00.

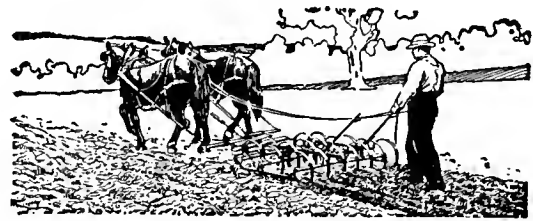

HARROW, McCORMICK-DEERING, SPRING TOOTH, WITH LEVERS

	Price
9-tooth, 1-horse, with handles, weight 126 lbs.	\$18.00
15-tooth, 2-horse, two sections, weight 210 lbs.	25.00
17-tooth, 2- or 3-horse, two sections, weight 228 lbs.	27.00
Sulky attachment for 15- and 17-tooth Harrows.	13.50



HARROW, McCORMICK-DEERING DISC

For crushing clods, pulverizing hard-baked clay land, or cutting up sod ground, no harrow rivals this one. It is made with a much stronger frame than the ordinary type of disc harrow, being made of a heavy angle steel cross-bar to which draft links are fastened. Made with either solid or cutaway discs. It is made in different sizes for horses or tractors. Can be supplied with fore carriage and transportation trucks or separate if desired. Prices on application.

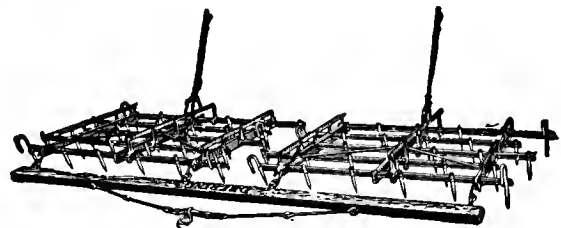

HARROW, McCORMICK-DEERING, PEG-TOOTH

This harrow can be used with great success on stony ground. Teeth can be quickly set at any desired angle by the lever. One section, with evener, for one horse, \$12.00; two sections with evener, for two horses, \$23.00.

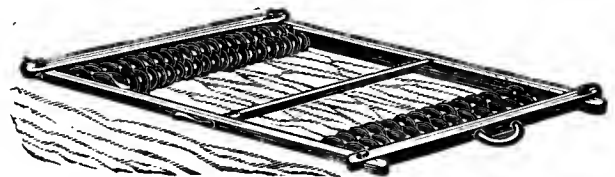

MEEKER SMOOTHING DISC HARROW

Designed especially for market gardeners' work. A perfect harrow and landroller combined. The frame measures 6 ft. 8 in. by 6 ft., and has four sets of rollers, having 58 steel discs 8 in. diameter on them. The discs grind all the lumps so fine that the seed must come up, leveling and leaving the land fine and smooth and does its work far better than the rake. Price, \$40.00.

FARM AND GARDEN TOOLS AND IMPLEMENTS—Continued

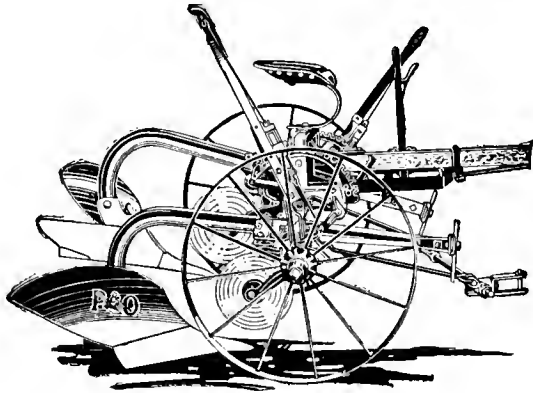

P. & O. SUCCESS SULKY PLOW

Throws all furrows the same way. Leaves no dead furrows. The Two-Way Success has a right and a left hand bottom. Instead of plowing around the land, it plows on the same side all the time, using the right hand bottom one way and the left hand bottom returning. This method leaves the land in a "solid body," eliminating dead and back furrows. It is, therefore, the proper plow for hillsides, irrigated fields and irregular fields, though it is equally efficient as a general purpose sulky. Equipped for two or three horses. Price \$110.00.

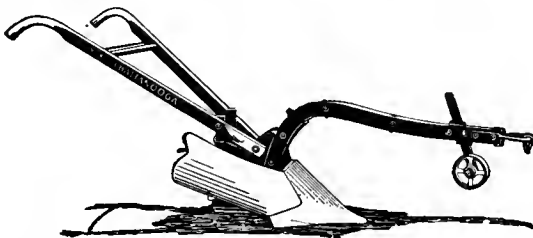

THE CHATTANOOGA STEEL HILLSIDE PLOW

The very latest series of steel hillside plows manufactured. They are the result of years of experiment and for strength, lightness and ease of draft cannot be equaled; while intended for hillside work, will do equally as good work on level land.

- No. 208. 1-horse plow with wheel.....\$15.00
- No. 209. 2-horse Plow, complete with cutter or jointer..... 24.00

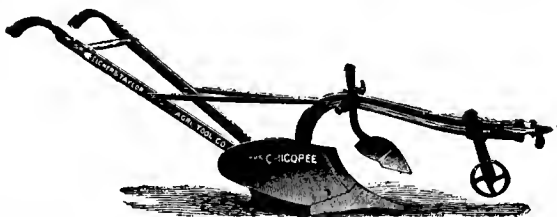

THE COMBINATION STEEL BEAM LANDSIDE PLOW

The latest and most up-to-date steel landside plows on the market. Furnished with jointers or cutters, as desired.

- No. 97. Regular 2-horse, complete.....\$28.00
- No. 100. Regular 2-horse, same as above, but with shorter beam. Specially adapted for stony ground. Complete.. 26.00

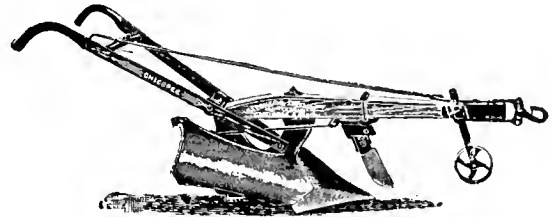
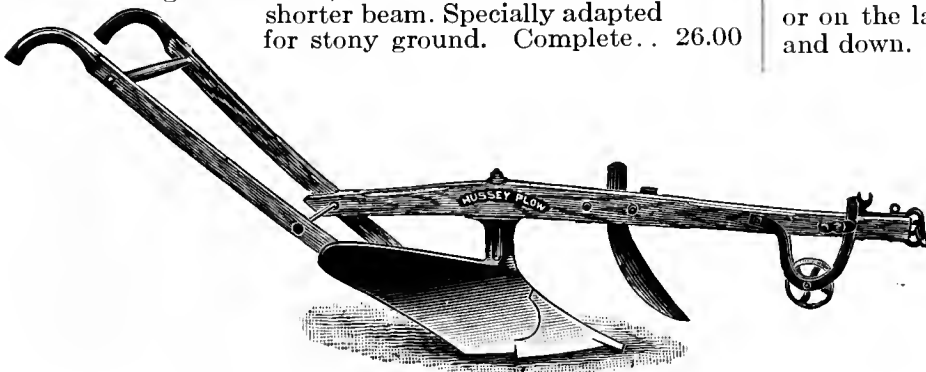

THE ORIGINAL 76 WOOD BEAM HILLSIDE PLOW

This pattern of the popular A. B. C. Series is of light weight and thoroughly constructed. The woodwork is cut from clear, straight-grained, well-seasoned hardwood; handles can be raised or lowered. Has automatic cutter, shifting lever elevis and a spring foot latch. Made in two sizes.

- B. Regular 2-horse, complete with wheel and cutter.\$24.00
- C. 1-horse, complete with wheel..... 15.00

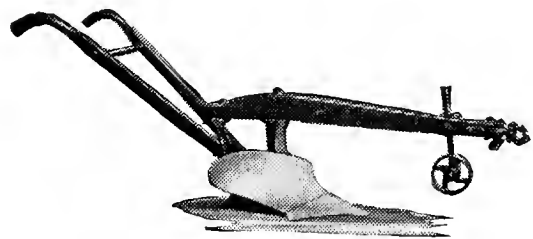

THE ONE-HORSE WOOD BEAM PLOW

Beam adjustable so that the horse can walk on the land or in the furrow.

- No. 1. 1-horse plow. Will turn furrow 5½ in. by 11 in.....\$13.00
- No. 52. Grey's Special. Regular, 1-horse plow with wheel..... 16.00



THE VINEYARD AND GARDEN PLOW

Chilled wearing parts. Horse can walk in the furrow or on the land. Handles can be adjusted sideways or up and down. Iron beam, 1-horse, with wheel, \$13.50.

PLOWS, HUSSEY HARD METAL

- No. 100. 1-horse. Furrow 5 to 6 in. deep, 10 in. wide.....\$15.00
- No. 102. Light 2-horse. Furrow 5 to 7 in. deep, 12 in. wide..... 17.00
- No. 104. Medium Sward. Furrow 8 in. deep, 16 in. wide..... 22.00

FARM AND GARDENS TOOLS AND IMPLEMENTS—Continued

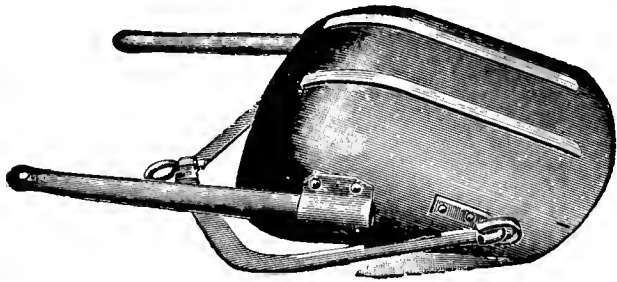
**AMERICAN STEEL DRAG SCRAPER**

Our late addition of a steel drag scraper is of an improved pattern and made without seam or lap, pressed from a single plate of steel. The bowl is well rounded at the sides and curved upward to form the back. They are strong and substantial and made in three sizes. No. 1, 7 cu. ft., \$12.00; No. 2, 5 cu. ft., \$11.00; No. 3, 3 cu. ft., \$10.00.

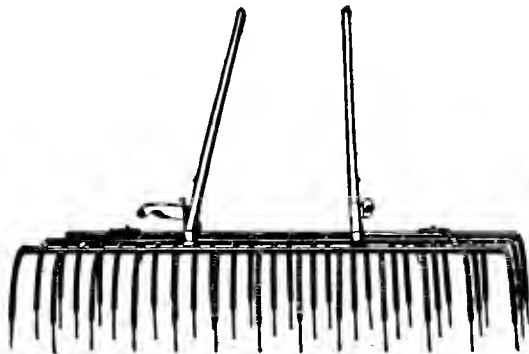
**7 1/2-FT. HORSE WEEDER**

By the use of weeders much time and labor are saved, and better crops grown. They will not cut the roots of the crop, but cultivate just deep enough to retain the moisture, where it is most needed. It is good policy to use the weeder after a heavy rain, when the ground has been beaten down. Use the weeder early and often and you will be surprised at the results. Price, \$16.00

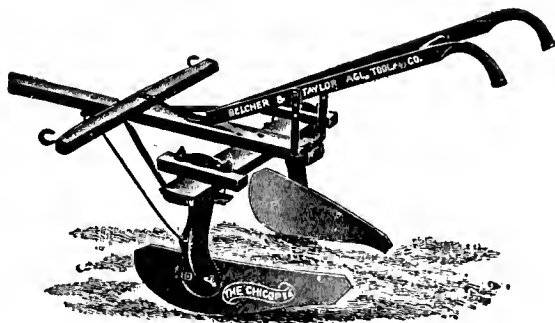
**THE SHOVEL POTATO HOE**

It is made to meet the demands of large growers of potatoes, being designed both for hilling and covering purposes. The blades are of steel and can be tilted upward to assist in shaping the hill, also can be moved upon the cross-bar when necessary. The frame is of hard wood, thoroughly constructed and braced. The handles are adjustable to suit the height of the user and can be moved to right or left so that the operator may walk between the rows. Price, \$16.00.

McWhorter Man
Power Fertilizer
Distributor

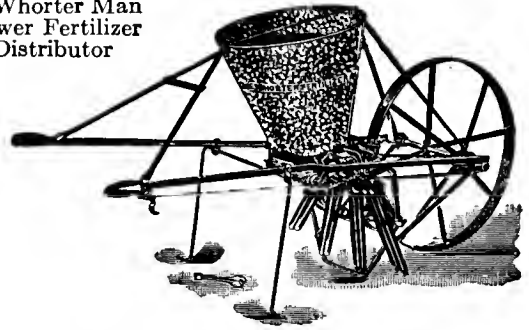
**McWHORTER HAND FERTILIZER DISTRIBUTOR**

It will distribute, broadcast, or in furrows, or between rows, or both sides of 1, 2, 3 or 4 rows, according to their distance apart at one operation. Any commercial fertilizer can be applied with it at any desired weight, from 5 to 40 lbs. per 100 yards of row. The fertilizer is forced through eight distributing spouts, which may be contracted to cover a 4 in. strip, or they may be spread into any position not exceeding 2 1/2 ft. in width. We call special attention of this ability to spread the fertilizer with this machine; especially recommended for top dressing strawberries. It makes a beautiful and uniform spread of the fertilizer in row or bed of strawberries up to 2 1/2 ft. wide. The distributor is light, made rigid and strong, and is easy and pleasant to use by man or boy. Price \$20.00.

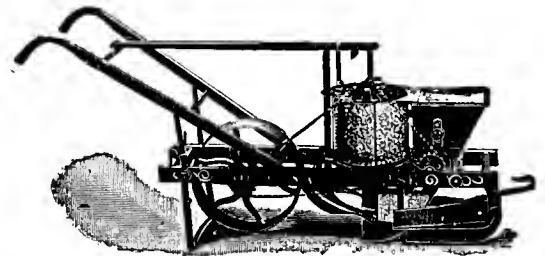
**KING OF THE CORNFIELD
CORN PLANTER AND FERTILIZER DISTRIBUTOR
COMBINED**

For planting field or ensilage corn, beans, peas or beet seeds, in hills or drills with check. Will accurately distribute all commercial fertilizer, wet as well as dry, pulverized hen manure, plaster, ashes and other fertilizers of like consistency, with a certainty. Has concave places each side of plow, which are of great importance in placing moist earth on the seed, just before the fertilizer is dropped each side of seed. A great advantage in a dry season. Price, \$42.00

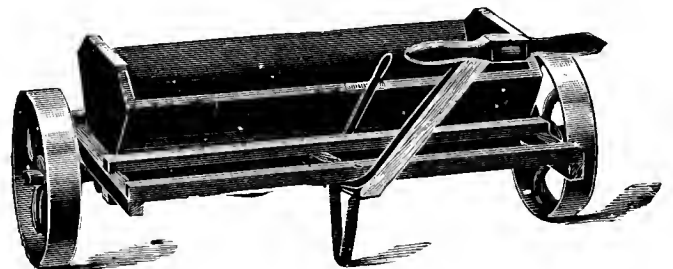
**FERTILIZER SOWER, THE STEVENS' HAND**

Does the work perfectly, sowing all kinds of lawn dressing and other commercial fertilizers, wood ashes, lime, etc., in large or very small quantities. It can also be successfully used for fertilizing strawberry beds, and other garden or field work; is excellent for sifting wood or coal ashes, sawdust, or dry sand on icy walks; will sow damp sand by removing two blades. The hopper is 34 in. long and holds 1 1/2 bus. Weight of machine, 83 lbs. It is well made and nicely painted. Price, \$18.00.

FARM AND GARDEN TOOLS AND IMPLEMENTS—Continued

**RAKES,
GUMFINGER
LAWN RUBBER**

The teeth are live, resilient rubber, stiff enough to rake clean, but flexible enough not to tear or uproot the grass. Rakes clean over rough surface. The rubber teeth adjust themselves to

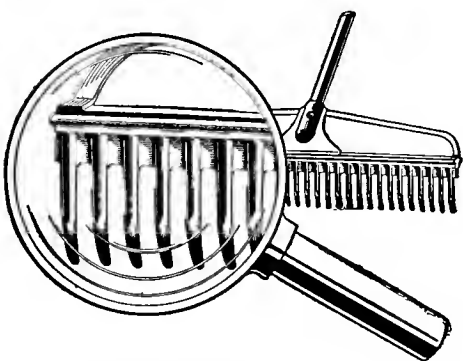

every irregularity in the ground. Light and easily handled. There is no risk of injury if this rake is left with the prongs turned upright. Made in three sizes: 16 in. \$1.00, 20 in. \$1.25, 24 in. \$1.50.

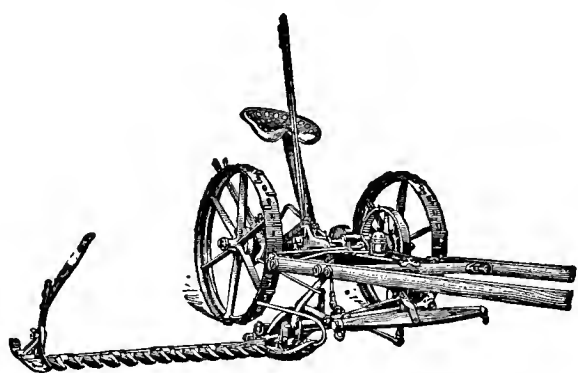

MOWER, McCORMICK-DEERING ONE-HORSE

This gives entire satisfaction on farms, salt meadows and orchards. Many of the parks use it. It is fitted with ball bearing rollers, long wooden pitman, forged steel couplings, a positive and direct stroke. Its action perfectly free, which makes it the most durable, easy of handling and lightest draft mower made. Cuts 3½ and 4 feet. The foot lift cannot be surpassed. The knives and section are made from a special grade of steel. They are stamped with the name, a satisfactory guarantee. Price on application.

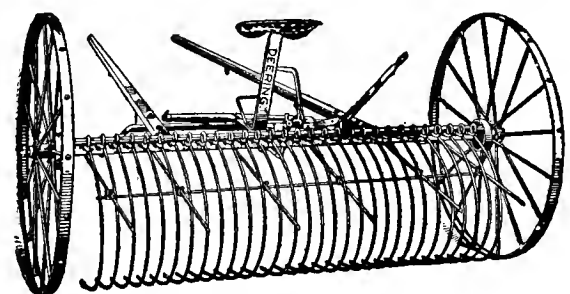

HAY RAKE, McCORMICK-DEERING

This self-dump rake is well built, sturdy and will stand up and do the work successfully under the most severe raking conditions. The best quality of steel is used throughout, and the wheels are large, durable, and well made. Price on application.

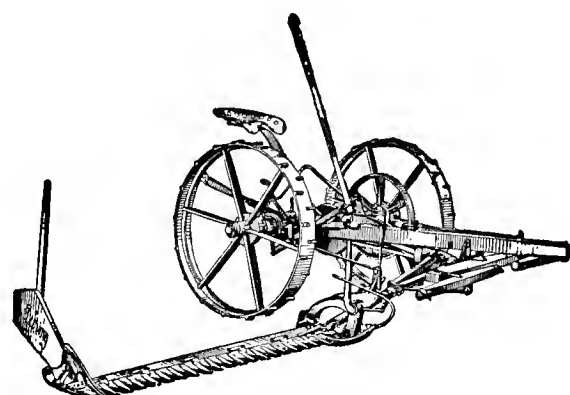

MOWER, McCORMICK-DEERING TWO-HORSE

Weight properly distributed is absolutely essential in mowers to insure machines that will do satisfactory work under all conditions. The working parts of these mowers are made of the best steel, malleable and wrought iron. The pitman is long and strong, made of well seasoned second-growth hickory. The wheels are high and powerful, are connected by a heavy steel axle. The frame is staunch and wide, striding the cut grass, so that the wheels travel in a clear track. Roller and ball bearings make these mowers so light in draft that it is a worthy example of the well-known line of machines. These mowers have a perfectly floated cutter bar; a coil spring not only assists the operator in raising the cutter bar but takes just enough of the weight of the cutter bar off the ground to permit the bar to float with perfect ease and freedom. Price on application.

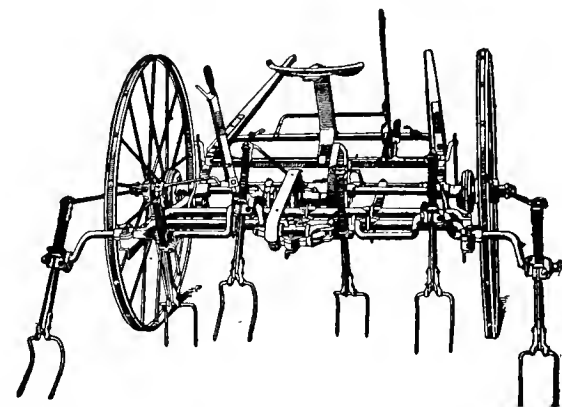

HAY TEDDER, McCORMICK-DEERING

Every farmer can secure a first-class quality of hay if he uses a hay tedder. Tedded hay brings higher prices in the market, for the reason that it is cured in the correct way, and therefore makes a better dry feed for cattle and horses. Price on application.

NORTHLAND STONE BOATS AND HEADS

Strongly bolted. Heavy wood work; made in two sizes; 6 feet and 7 feet in length and 32 inches in width. This boat has a steel head. The wood part is made from rock maple and the whole thing is thoroughly well bolted, making the very best pattern of stone boat in the market. The heads are equipped with a full set of bolts. Prices: 6 ft. boat \$15.00; 7 ft. boat \$18.00; heads alone with bolts, \$7.00.



Hand Garden Tools and Seeders

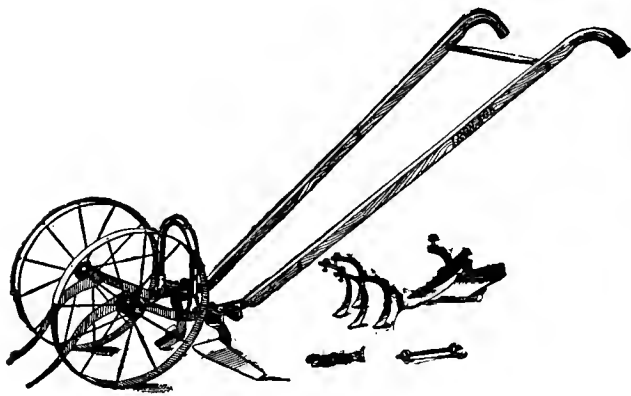

NO. 301 DOUBLE AND SINGLE WHEEL HOE

The garden or farm is incomplete without at least one of these. In cultivating onions, beets, turnips, radishes, etc., it is invaluable; saves hours of hard labor and does the work better than several men could do it in the same time. One great advantage which this double wheel hoe possesses is that it can be made into a single wheel hoe in a moment's time. An axle is sent with every double wheel hoe for this purpose. The wheels are 16 inches high, enabling the wheel hoe to run easily and without yielding to the depressions of the soil, as a low wheel will do. The frame being made of tubing coupled to malleable castings gives great strength, together with lightness. Price \$10.00.

No. 303. The same tool as 301 without vine lifters, cultivator teeth or plows. Side hoes only. \$7.50.

No. 313. The same tool as 301 without plows or vine lifters. Side hoes and four cultivator teeth only. \$9.00.

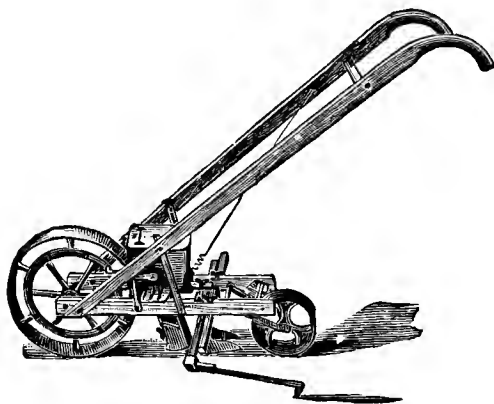

THE NEW MODEL SEED DRILL

This we consider the simplest and best drill on the market. The diamond-shaped adjustable hole regulates the discharge, and can be made larger or smaller as occasion requires. No other drill has this advantage. The seed cut-off claps up underneath the hole; it does not slide under the same, as in other similar drills; on this account it does not clog nor cut the seed. It has a broad wheel and a covering roller. The opening plow is adjustable in depth. The whole makeup of the drill is simple. It can be worked by anyone. Price \$13.50.

NO. 19 C. SINGLE WHEEL CULTIVATOR AND PLOW

If you have never tried a wheel hoe for your garden, get one of these and see how easy it is to keep your ground under perfect cultivation. The distinctive feature of this tool is the high steel wheel measuring 24 inches with land-side plow, scuffle hoc and cultivator teeth, complete, \$5.50.

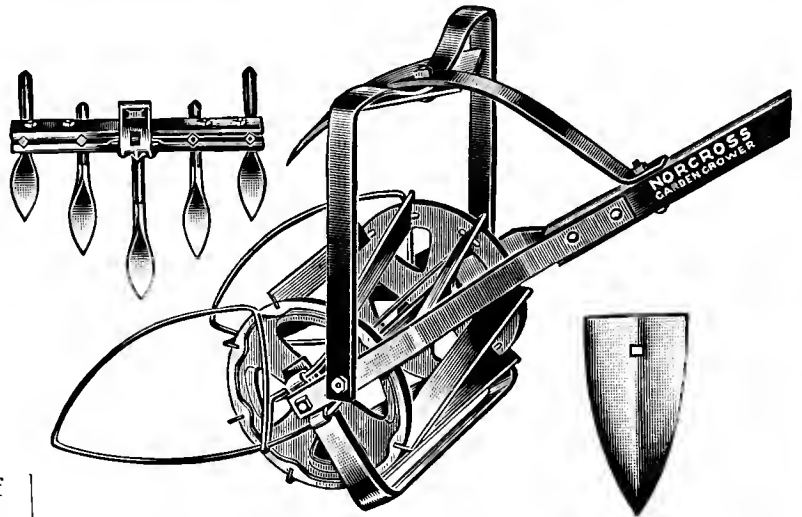

THE NEW NORCROSS GARDEN GROWER

It Plows—It Weeds—It Cultivates—It Mulches

The very last word in garden implements—a device which embodies every essential tool for the proper conditioning and maintenance of the soil in the family or commercial garden. The new **Norcross Garden Grower** positively banishes the back-breaking drudgery and work of garden planting, weeding, cultivating, and mulching, by performing these operations in a quick, easy way, without bending, kneeling, stooping, pulling, tugging or hand hoeing.

Simple to Operate—Well Made

Advantages—Destroys weeds that infest the garden and rob plants of moisture and nutriment—rids gardens of injurious insects attracted by weeds—keeps soil mellow and increases garden yield—works in all kinds of soil. Leaf guards permit all-season use by protecting large or overhanging leaves from wheel movement—works faster, better and easier than other methods.

Complete as illustrated, with the famous Norcross 5-prong cultivator (with heavy steel prongs). Announced by gardeners as the greatest cultivating instrument ever designed. Also a large 5x9 inch oval shovel for laying off rows, deep plowing and hilling. Made in two sizes:
No. 8—8 in. wide. Price complete.....\$6.00
No. 10—10 in. wide. Price complete..... 7.00

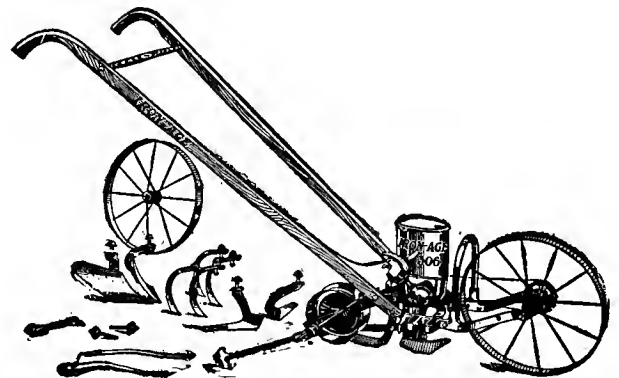

NO. 306 COMBINED HILL AND DRILL SEEDER DOUBLE AND SINGLE WHEEL HOE

Many men should use combination tools for two reasons: They save in first cost and they take up less room.

Thousands of gardeners have found this to be true of No. 306. Of course, most market gardeners prefer to have separate tools always ready to do each separate piece of work—drills, wheel hoes, wheel plows, etc. We have them in great variety, to suit each purpose in a particular way. Complete \$18.00.

Lawn Rollers and Sprinklers

MODEL D RAIN KING

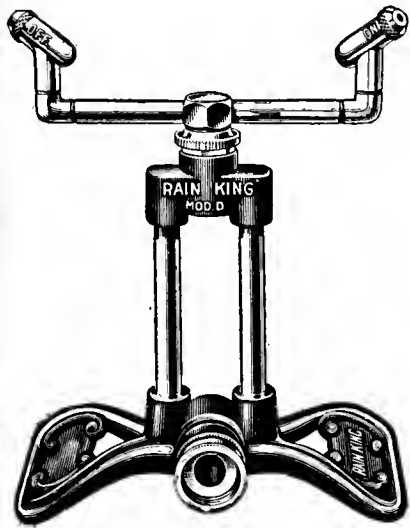

The latest Rain King and the world's greatest sprinkler value. Most beautiful in appearance and exceptionally efficient on all water pressures or any spray. Fitted with latest patent Rain King nozzles which require just a touch to adjust for any spray or direction. Sets quickly to turn fast or slow—or for stationary sprinkling. Has double brass water column, wide spread base with exceptionally easy hose coupling. It's a thing of beauty and a joy to the user. Finish, red and brass; height, 9 in.; width, 7¼ in.; net weight, 2½ lbs. Price, \$1.50 each

THE MAJESTIC

Has all the adjustments of other Rain King Sprinklers; stands 15 in. high, has double spray water columns, and is built a little heavier than the Standard, with farther throw of water. Because of its extra height, throws spray well out over tops of nearby plants. Has bird bath base. Price, \$5.00 each.

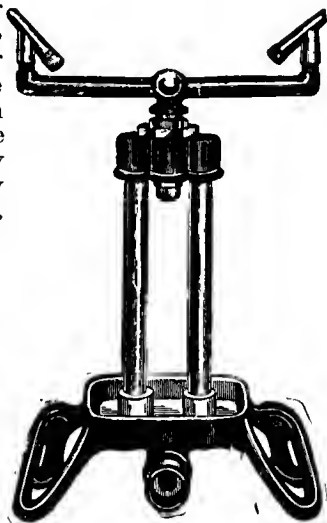

THE MAMMOTH

For golf courses, parks, large estates, etc. Will throw more water over a larger surface and distributes it more evenly than any other sprinkler. At a single setting, it will sprinkle an area up to 6000 feet, dis-

charges 1000 gallons of water per hour on 45-lb. pressure. Height 3½ feet. Spread of arms 4 ft. Price, \$19.75 each.

SENSATIONAL NEW RAIN KING, THE A-1

This most popular priced Rain King offers extreme value and unmatched performance. Has a new type of nozzle, eliminating nozzle stem and lock nut, which throws a fine spray as far as other nozzles will throw a solid stream and will throw a solid stream even farther. Every adjustment of spray from a solid stream to a complete shut off with just a quarter turn of the front end of the nozzle. The A-1 does sprinkling which cannot be duplicated by any other sprinkler. Price, \$3.25 each.

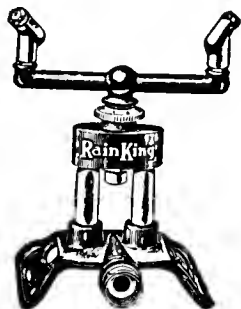

NEW IMPROVED DOUBLE WHIRLING SHOWER LAWN AND GARDEN SPRINKLER

Sprinkles exactly like rain—throws beautifully diffused spray which drops gently to the ground without damage to tender young growth or washing away of surface soil. Sprinkles circles up to 35 ft. in diameter. Runs on any pressure from 5 lbs. up. Extremely well built with precision fitted phosphor-bronze bearings. Beautiful in appearance and most impressive in action. Throws more water and throws it farther than any other sprinkler of its type. A child can use it, it's so easy to attach to the hose and so simple to set in the ground anywhere desired.

Length over all, 12 in. Finish, red and brass. Entire sprinkler of non-corrosive metal. Will not clog. Will not leak.

Price, 75c. each

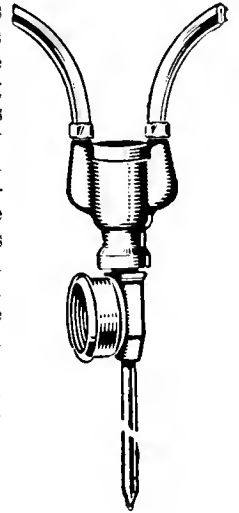

IMPROVED "RING" SPRINKLER

Heaviest all-brass ring sprinkler on the market. Waters circle 30 to 40 ft. in diameter. Price, 75c. each.

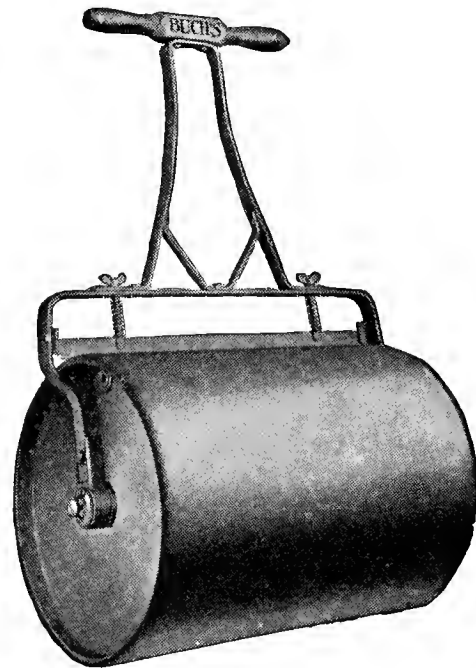

WATER BALLAST LAWN ROLLERS

Adapted for rolling lawns, golf courses and tennis courts. Light running, round edge. No tearing up of sod. Scraper to keep surface clean. Roller bearings in the following sizes:

No.	Diam. Inches	Length Inches	Weight Empty	Filled with Water	Price
602.....	18	24	85	265	\$16.50
603.....	24	24	110	420	19.00
604.....	24	32	130	566	21.00
Plain bearings in the three sizes below:					
605.....	14	24	68	175	11.00
606.....	18	24	82	265	13.00
607.....	14	15	50	115	10.50

Oilskin Clothing, Etc.



Cape Ann Hat

Oilskin Hats (Sou'wester). Either yellow or black 1.00
Waterproof Dressing for Oilskins. Either yellow or black. 75c. per can.

When spraying with lime sulphur, arsenate of lead or other solutions, a waterproof suit is essential to protect the flesh and clothes. Those we offer are especially designed for men who work at spraying or whose work takes them into wet places and who require light-weight, waterproof garments.

Oilskin Long Coats. Either yellow or black Each \$6.50
Oilskin Jackets. Either yellow or black 3.00
Oilskin Pants. Either yellow or black 3.00



Oilskins

Rubber Boots

Either in black or red. Finest quality only. In all sizes and styles.

Men's Hip Boot. Per pair \$6.00
Men's Storm King. Comes just above knee. 5.00
Men's Short Boot. 4.00

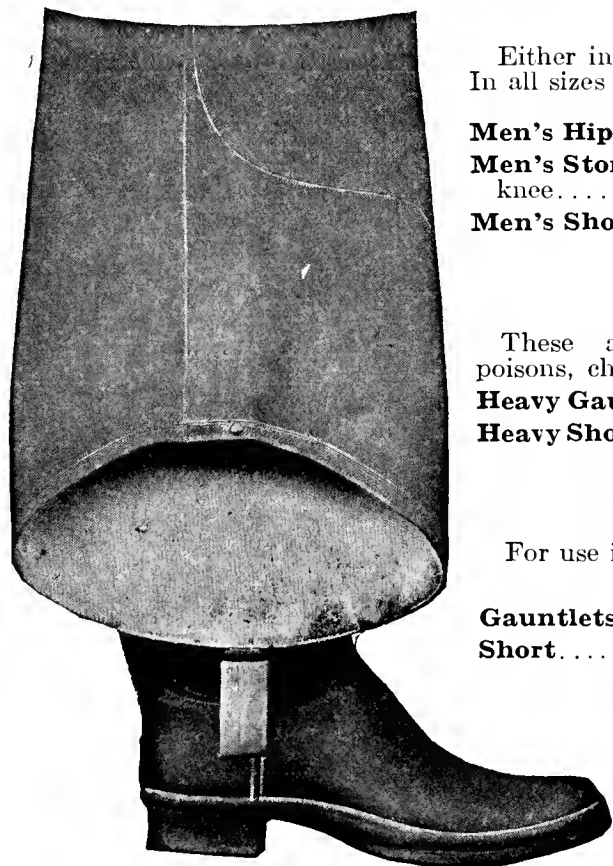

Rubber Boots

Rubber Gloves

These are indispensable when handling poisons, chemicals, etc.

Heavy Gauntlet. Per pair \$3.00
Heavy Short. 2.00

Leather Gloves

For use in spraying, pruning or garden work

Gauntlets. Per pair \$2.00
Short. 1.50

Rubber Aprons

Used by florists and gardeners. Standard size. Best material. \$2.00 each.

Pomona Spray Pump

The Pomona has sufficient capacity to supply two leads of hose and four nozzles. The plunger, plunger connection, gland, valves, valve seats and strainer are of solid bronze. All working parts are simple and so located that they can be easily removed and cleaned. The air chamber is of steel and has a large capacity, making it easy to maintain the pressure and giving smooth operation. The lever can be adjusted for a 3, 4 or 5 inch stroke, the adjustment being obtained by removing and replacing a single bolt. The agitator is very simple but effective, and is operated by the pump lever.

Pump, with agitator and hose couplings. Price \$22.00
Pump, with agitator and one lead of 15 ft. 1/2 in. discharge hose with spray nozzle. 28.00
Pump, with agitator and two leads of 1/2 in. discharge hose with spray nozzle. 34.00
 Either of the above mounted in barrel for \$10.00 extra
Extension Rod. Bamboo, brass-lined with stop-cock. 4.00

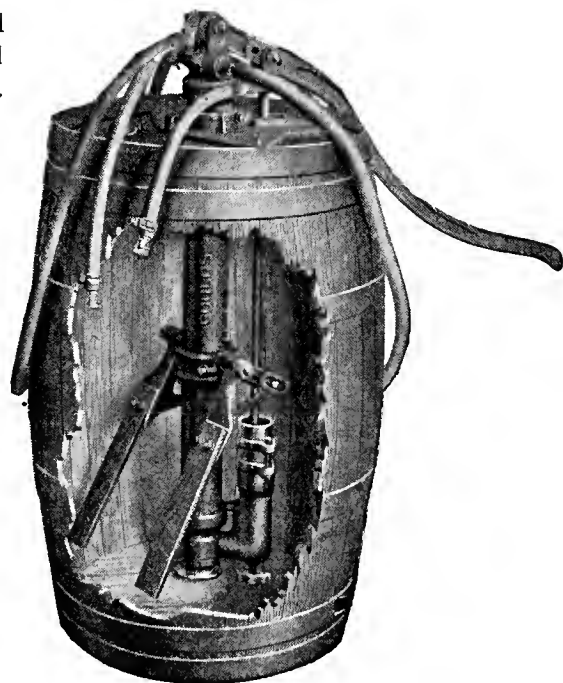

Pomona Spray Pump

Goggles

To protect the eyes when spraying. \$1.25 each.

Insecticides and Fungicides

NOTICE—Articles prefixed by star (*) cannot be sent by mail.

***Aphine.** For the destruction of the green, black and white fly, thrips, red spider, mealy bug, caterpillars, scale, etc. It is a combination of essential and ethereal oils, combined with nicotine in a readily soluble and available form and can be applied as a spray, wash or dipping solution. Qt. \$1.25, gal. \$3.50.

***Arsenate of Lead (Dry).** Lb. 25c., 5 lbs. \$1.00, 25 lbs. \$4.00.

Acme All 'Round Spray. For destroying blight and fungous diseases, controls sucking insects and destroys chewing insects in one application. $\frac{1}{4}$ lb. 30c.

***Black Leaf 40 (Sulphate of Nicotine).** A concentrated liquid for use in destroying green aphids and thrips. Oz. bottle 35c., 5 oz. \$1.00, lb. \$2.10, 2 lbs. \$3.10, 5 lbs. \$5.85, 10 lbs. \$10.15.



***Bordeaux Mixture, Dry.** Can be used either dry as a dust or mixed with water as a spray for all fungous diseases. 1 lb. to 5 gals. of water. 1 lb. 25c., 4 lbs. 80c., 25 lbs. \$4.00.

Bye, Bye, Blackbird. A safe remedy for the user, but sure to rid corn fields of crows, blackbirds, etc. Harmless to plant life, but should not be brought in contact with the body. $\frac{1}{2}$ pt. 60c., pt. \$1.00.

Carbola. A combined disinfectant, insecticide and cold water paint. Used extensively in the garden, barn, poultry or greenhouse. Recommended for shading greenhouses; unexcelled as a whitewash. 5 lbs. 75c., 10 lbs. \$1.25, 25 lbs. \$2.75, 50 lbs. \$5.00.

***Copper, Ammoniated Solution of.** A liquid fungicide, ready for use. Dilute at the rate of 1 qt. to 25 gals. of water, and spray lightly. Qt. \$1.50, gal. \$4.00.

***Creosote, Gypsy Moth.** For the destruction of the eggs of gypsy moth. Qt. 50c., gal. \$1.25, 5 gals. \$5.00.

***Cattle Spray.** Protects cattle and horses from flies. A sure preventive, easily applied with sprayer. Gal. \$1.50.

***Cyanogas (Calcium Cyanide).** "Grade A." Will destroy ants, rats, ground hogs, etc. $\frac{1}{2}$ lb. 45c., lb. 75c., 5 lbs. \$3.00.

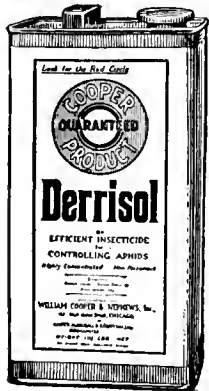

***Cyanogas (Calcium Cyanide).** "Grade G." For greenhouse fumigation, garden insects and other pests. 5 lbs. \$3.00, 25 lbs. \$10.00.

***Derrisol.** A safe, non-poisonous contact insecticide for the control of aphids or plant lice, red spider, green fly, and many other soft-bodied sucking insects. Inexpensive and effective. Oz. 35c., 10 lbs. \$12.00.

***Fungine.** An infallible remedy for mildew, rust, wilt, bench rot and other blights affecting flowers, fruits and vegetables. It is equally effective under glass and out of doors. A sulphur composition which diluted with water contains no sediment and does not stain the foliage. One gallon makes fifty gallons spraying material. Pt. 75c., qt. \$1.25, gal. \$3.50.



***Fungtrogen.** An effective and scientific preventive and remedy for mildew, black spot and many fungous diseases for Roses and other plants. Pt. \$1.25, qt. \$2.00, $\frac{1}{2}$ gal. \$3.50, gal. \$6.00.

Grape Dust. For destroying mildew on grape vines and trees affected with mold, mildew or rust mites. 5 lb. pkg. 90c.

***Lemon Oil.** A safe and effectual insecticide for all insects and soft scale, highly recommended for house plants. Qt. 85c., gal. \$2.50.

***Lime-Sulphur Solution.** Will completely destroy San Jose and other scale. A clear-colored liquid, free from all worthless sediment, and contains the highest percentage of lime and sulphur possible in solution, and if not exposed to the air will remain so a long time. Qt. 50c., gal. \$1.00, 5 gals. \$3.50. $\frac{1}{2}$ barrel, about 30 gals., 50 gal. barrels, price on application.

***Lime and Sulphur, Dry.** For dormant spraying of fruit; used for same purposes as Liquid Lime Sulphur, but is much easier to handle. 1 lb. 30c., 5 lb. \$1.25, 10 lbs. \$2.00, 25 lbs. \$3.50.

Nico-Fume Tobacco Paper. (Registered.) For fumigating greenhouses. Positively the strongest Tobacco Paper on the market. In special friction-top tins, sold as follows: 24 sheets \$1.25, 144 sheets \$4.50, 288 sheets \$8.00.

Nico-Fume Powder. For fumigating. 5 lbs. \$3.35, 10 lbs. \$5.85.

***Nico-Fume Liquid.** A nicotine solution of exceptional purity. Does not stain or injure blooms or leave a disagreeable odor. 1 lb. \$2.25, 4 lbs. \$5.75, 8 lbs. \$10.00.



***Nicotine Pyrox.** Combined poison and fungicide for the control of aphid, external chewing insects and plant diseases. 10 oz. jars. 50c.

***Paris Green.** Strictly pure. $\frac{1}{2}$ lb. 35c., lb. 60c.

***Pomo-Green with Nicotine.** The Leaf Green All-in-one Dust or Spray. A single material used as a dust or spray; for all leaf-eating or sucking insects, and aphid. Also diseases on Roses, flowering plants and shrubs without being conspicuous on foliage. 1 lb. can 75c., 5 lb. can \$3.00.

***Pyrox, Bowker's, The New Improved.** The one best spray for all leaf-eating insects. Does all that arsenate of lead will do, besides protecting trees, shrubs, vegetables and plants against fungous diseases, one application answering both purposes, saving labor and expense. All ready to use by adding water. 1 lb. 50c., 5 lbs. \$1.75, 10 lbs. \$3.25, 25 lbs. \$6.25. Larger quantities, price on application.

***Richard's X L All, Liquid Insecticide.** Destroys mealy bug, red spider, etc. Qt. \$3.00, $\frac{1}{2}$ gal. \$5.50, gal. \$10.50.

INSECTICIDES AND FUNGICIDES—Continued

***Scalecide with Fungicide.** The most reliable, simple and economical remedy for destroying San Jose scale, mussel scale, brown scale, red scale, cottony maple scale and all other scale and soft-bodied sucking insects. Also all fungous diseases. Mixes instantly with cold water and stays mixed. Will not injure the trees. Qt. 60c., gal. \$1.40, 5 gals. \$4.90, 10 gals. \$8.50; 50 gals., price on application.

Semesan. Semesan may be applied in dust or liquid form to the seed before planting. It is harmless to seed but deadly to disease organisms which may be on the seed. 1 oz. treats 15 lbs. of seeds. Effective in controlling damping off. 2 ozs. 50c., lb. \$2.75, 5 lbs. \$13.00.

Slug Shot, Hammond's. Destroys insects injurious to house and garden plants, vegetables and fruit of all kinds. Directions for use on each package. 5-lb. pkg. 65c.

***Soap Spray, "Imp."** The base is pure soap. It contains vegetable poisons, harmless to plants, but peculiarly effective against red spider on fruits, etc., the Rhododendron fly, Rose bug and other insect pests on fruits, flowers and foliage. It sticks, but can be easily washed off before marketing. 1 gal. (can) makes 12 gals. of spraying fluid. Qt. \$1.00, gal. \$3.00, 5 gals. \$11.00, 10 gals. \$19.00. Specially recommended and very effective in killing white fly.

Soap, Fish Oil. Is a most effective, reliable, simple and cheap preparation for destroying San Jose scale, plant lice and all sucking insects on trees, shrubs, plants, vines, Rose bushes, etc. Full directions for use on each package. Lb. box 45c., 5-lb. box \$1.50.

Soap, Sulpho Tobacco. A very effective insecticide for use on plants in the house or outside. 3-oz. cake 10c., ½ lb. cake, 25c. each.

***Sulfocide.** A powerful Summer fungicide for fruits, flowers and vegetables, for the control of apple scab, brown rot of peaches and other diseases. 1 gal. makes 200 gals. of spray. Qt. 85c., gal. \$2.25.

Sulphur Flour. Useful for fumigating, spraying mixtures, lice on plants or animals. Prevents mildew on Grape vines, bushes, etc. Lb. 10c., 5 lbs. 40c., 10 lbs. 75c., 25 lbs. \$1.75, 100 lbs. \$6.50.

***Sylpho-Nathol.** Of value as a disinfectant as well as an insecticide. Pt. 65c., gal. \$4.00.

***Thrip Juice No. 2.** Very effective in destroying thrips on Grapes, aphids, red spider, mealy bug, and other sucking insects. Qt. \$1.25, gal. \$3.75.

Tobacco Dust. For aphids, etc., on the foliage and around the roots. Lb. 15c., 5 lbs. 50c., 25 lbs. \$2.00, 50 lbs. \$3.50, 100 lbs. \$6.00.

Tobacco Stems. Small quantities. Lb. 5c., \$1.00 per bbl.; large bales or cases, lb. 4c.

***Vermine.** A soil sterilizer and germicide for all soil vermin, such as cut, eel, wire and grub worms, slugs, root lice, maggots and ants. Used in the greenhouse, garden and field. One part Vermine to 400 parts water, thoroughly soaking the ground, does its work effectively without injury to vegetation and protects your crops and lawns against the ravages under soil. Pt. 75c., qt. \$1.25, gal. \$3.50.

Volck. One of the most powerful insecticides known for the control of red spider and scale. Volck is non-poisonous. Must not be used in connection with lime or sulphur. Qt. \$1.00, gal. \$3.00, 5 gals. \$12.00, 14 gal. drum \$25.00.

***Wilson's O. K. Plant Spray.** Powerful yet harmless. A contact spray for Roses, Chrysanthemums, Carnations, Grape vines (when dormant), etc. Qt. \$1.00, gal. \$3.00, 5 gals. \$12.00, 10 gals. \$22.00, 25 gals. \$50.00, 50 gal. bbl. \$90.00.

"HERBICIDE"

THE WEED EXTERMINATOR

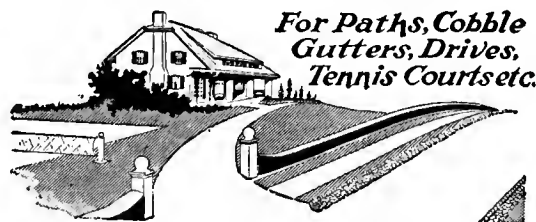

***Weed Exterminator, "Herbicide."** Is a powerful chemical solution for destroying weeds and vegetation of all kinds on roadways, paths, gutters and tennis courts. It is highly concentrated and each gallon may be diluted with 50 gals. of water. When the ground is drenched with the diluted material, both the tops and roots are destroyed.

Size of Package	Retail Price	Size of Package	Retail Price
1 qt. can.....	\$0.60	5 gal. can.....	\$7.50
1 gal. can.....	1.75	10 gal. can.....	12.50



Ever Green. Kills cut worms. Non-poisonous. Will not burn or injure the tenderest crop. Does not injure the soil in any way. Will not gum sprayers. Pleasant and easy to use. No unpleasant odor. When diluted Ever Green retains its strength indefinitely. To kill cut worms, use 1 part of Ever Green to 100 parts of water. Spray around plants, wetting ground thoroughly. Cut worms coming in contact with the solution will come to the surface and die. Keep ground around plants moist. Do not use soap. Ever Green can also be used to control aphids, leaf hoppers, cabbage worms, mealy bug, and many other insects, killing practically all sucking and chewing

insects. Oz. bottles, 35c.; 6 oz. bottles, \$1.00; 16 oz. bottles, \$2.00; 32 oz. bottles, \$3.50; gal. \$11.50; 5 gal. keg, \$45.00. Special circulars giving detailed information mailed on request.

RED ARROW

NON-POISONOUS

INSECT SPRAY

(PYRETHRUM SOAP)

Red Arrow is a contact insecticide particularly adapted for flowers, fruits and vegetables. It kills both chewing and sucking insects and is especially recommended for the control of Mexican bean beetle and Gladiolus thrip, as well as aphids, leaf hoppers, etc. Red Arrow is absolutely non-poisonous and does not possess unpleasant odors or dangerous fumes. It does not require the addition of soap; simply mix with water and use. A very important thing about Red Arrow is that it is economical, combining the highest killing power with the greatest coverage. Harmless to man or pets. Oz. 35c., 3½ ozs. \$1.00, pt. \$3.25, qt. \$6.00, gal. \$20.00.

Agricultural Chemicals and Fertilizers

GREY'S 9-6-6 PLANT FOOD FOR LAWNS, Etc.

We have arranged with the largest fertilizer manufacturer in New England to make this special plant food for us.

GREY'S PLANT FOOD contains the necessary ingredients to feed your lawns, flowers, trees and shrubs.

GREY'S PLANT FOOD is a "complete" fertilizer, odorless, easy to handle and free of weed seeds.

GREY'S PLANT FOOD meets all the plant food requirements to promote a rich, luxuriant growth and an abundance of foliage and bloom.

GREY'S PLANT FOOD is adapted to lawns, golf courses and gardens. Also, may be used on trees and shrubs with splendid results.

Directions for use in every package.

10 lbs.....	\$0.75	50 lbs.....	\$2.50
25 lbs.....	1.50	100 lbs.....	4.00
Ton.....		\$70.00	



All prices subject to change without notice

BOWKER FERTILIZERS AND STOCKBRIDGE MANURES

Stockbridge Early Crop Manure, 5-8-7. A fertilizer especially adapted to soils lacking nitrogen and for use with all root and other vegetable crops. 100 lbs. \$2.75, ton \$45.00.

Stockbridge Potato and Vegetable Manure, 4-8-10. Well adapted to poor or lightly manured soils—especially for Potatoes, Beets, and for many foliage crops, except Cabbage, which requires considerably more available phosphoric acid. 100 lbs. \$2.75, ton \$45.00.

Bowker's Market Garden Fertilizer, 4-8-4. For vegetables and small fruits where a good balance of the three plant foods is desired. A good, high-grade fertilizer to use where moderate applications of manure are occasionally made. 100 lbs. \$2.50, ton \$40.00.

Bowker's Farm and Garden Phosphate, 2-10-2. Well adapted to potatoes or garden crops on rich soils, or on those where moderate to heavy applications of manure have been made in recent years. 100 lbs. \$2.25, ton \$35.00.

Bowker's All-Round Fertilizer, 3-10-4. True to its name, this is an excellent fertilizer for practically all crops on fairly rich soils or on those that have had only light applications of manure. 100 lbs. \$2.50, ton \$40.00.

Special Ground Bone. An excellent material for use where gradual but long continued effects of nitrogen and phosphoric acid are desired, as under and around perennials, trees and shrubs, or before seeding to grass. 5 lbs. 35c., 10 lbs. 50c., 25 lbs. \$1.00, 50 lbs. \$1.75, 100 lbs. \$2.75, ton \$45.00.

A.A. Superphosphate. 16 per cent. soluble and available phosphoric acid. 100 lbs. \$1.75, ton \$30.00.

Ashes, Unleached Hardwood. High in potash. In bags, per 100 lbs. \$2.50, per ton \$40.00.

Blood Tankage. 14 per cent. \$4.00 per 100 lbs.

Bon Arbor. Immediately soluble in water. A complete plant food, containing nitrogen, potash and phosphoric acid in sufficient quantities. 1 lb. pkg. making 30 gals. 60c., 5 lbs. \$2.50.

Bone, Coarse or Cracked. Ground coarse for Grape borders or poultry. 100 lbs. \$4.00.

Charcoal. Coarse and fine. 10 lbs. 50c., per 100 lbs. \$4.00.

Calcium Chloride. Dust layer and surface binder. 100 lbs. will cover about 50 square yards. 100 lbs. \$3.50, ton \$60.00.

Castor Pomace. 4.53 per cent nitrogen. Is an organic ammoniate used on lawns and golf courses. Used as a conditioner where one mixes his own formula, this aside from the nitrogen content as found in Castor Pomace. 100 lbs. \$2.00, ton \$35.00.

Chrysanthemum Manure, Thomson's Special. Entirely soluble and very powerful, especially suitable for top-dressing Chrysanthemum and similar plants. Price, 7 lbs. \$1.75, 14 lbs. \$2.75, 28 lbs. \$4.50, 56 lbs. \$8.00.

Clay's Fertilizers. This valuable imported manure is especially recommended to all who grow either fruit, flowers or vegetables and wish to bring them to the highest perfection. 14 lbs. \$2.00, 28 lbs. \$3.50, 56 lbs. \$6.50, 112 lbs. \$12.00.

Cottonseed Meal. Is being widely used by gardeners, florists, nurserymen, as well as on golf courses and vegetable gardens. The extremely low price and high fertilizer value make it well worth trying. 100 lbs. \$2.50, ton \$45.00.

Humus. Finely ground and screened for renovating lawns, golf courses, flower beds, etc. Improves potting soil. 100 lbs. \$2.00, ton \$30.00.

Lime, Agricultural. An unusually pure calcium lime, especially prepared for use on the soil. Shipped in the form of a dry powder in bags of 100 lbs. each. Per 100 lbs. \$1.25, ton \$18.00.

Mowrah Meal. Used extensively for killing earth worms on lawns and putting greens; a dry powder which should be spread on ground or grass evenly enough so that it can be readily seen, forming a light covering, then wet it down immediately with the garden hose so as to wash all the powder into the soil. 100 lbs. \$3.50.

Muriate of Potash. 50 per cent actual potash. 100 lbs. \$4.00.

Nitrate of Soda (Reground). 10 lbs. \$0.50, 25 lbs. \$1.00, 50 lbs. \$1.75, 100 lbs. \$3.00.

Premier Brand Pulverized Poultry Manure. Guaranteed analysis: Nitrogen 4.93 per cent, Equivalent to Ammonia 6.00 per cent, Total Phosphoric Acid 2.75 per cent, Available Phosphoric Acid 2.50 per cent, Potash 1.30 per cent. 100 lbs. \$4.00, 500 lbs. \$16.00, ton \$60.00.

AGRICULTURAL CHEMICALS AND FERTILIZERS—Continued

Salt. Top-dressing for lawns and Asparagus beds. Price per bag about 140 lbs., \$2.25.
Soot, Imported Scotch. Prevents mildew when mixed with sulphur at the rate of one-third sulphur and two-thirds soot; also a good fertilizer. Sold only in original bags at 6c. per lb.
Sulphate of Ammonia. 20.56 per cent nitrogen. \$3.00 per 100 lbs.

Sheep Manure Pulverized, "Special Brand." This brand has no objectionable odor; it is a pure natural manure, and the most nutritious food for plants. It makes the richest, safest and quickest liquid manure, without any deleterious effects. Minimum guarantee, 2¼ per cent Ammonia, 1½ per cent Phosphoric Acid, 1¼ per cent Water Soluble Potash. 5 lbs. 35c., 10-lb. pkg. 60c., 25 lbs. \$1.00, 50 lbs. \$1.75, 100 lbs. \$3.00, ton \$50.00.

Special Insecticides and Special Fertilizers

Antrol



The Antrol system kills ants in their nests. The species that infest the kitchen and eats food. Use Antrol for permanent quick relief.

- Antrol Ready-filled Feeders.....\$0.50
- Antrol sets containing 4 containers and 1 4-oz. bottle of syrup..... .75
- Antrol extra containers, each..... .10
- Antrol Syrup, 4-oz. bottle..... .35
- Antrol Syrup, pint..... .85
- Antrol Syrup, gallon..... 3.50



SNAROL

For cutworms, snails, slugs, etc. Simply broadcast Snarol on the ground under the flowers and plants. Water will not harm it.

- 1½ lb.....\$0.35
- 4 lbs..... .85
- 15 lbs..... 3.00
- 50 lbs..... 8.00

TO-NA-CIDE

A successful preparation for the control of insect pests which infest the soil. It is a positive control for such insect pests as greenhouse thrip, sow bugs, manure worms, etc. Apply at the rate of 1 lb. to 40 sq. ft., watered in.
 25 lbs. \$5.00, 50 lbs. \$8.00, 100 lbs. \$12.50

ADCO

For making artificial manure. Dry leaves mixed with Adco and kept moist, turn into excellent manure. So do flower stalks, cuttings, pea vines and almost any other kind of non-woody vegetable waste. Adco is a powder which, mixed with vegetable matter and kept moist, turns the latter into real manure, but without odor, flies, etc. The process is perfectly simple and not at all laborious.

- In 25 lb. bags.....Each \$2.25
 (Enough for about 12 wheelbarrow loads of garden waste, making ½ ton of manure)
- In 150 lb. bags.....Each \$10.50
 (Enough for a heap 10 ft. x 6 ft. making about 3 tons of manure)

Each shipment is accompanied by simple directions which makes any mistake impossible.

CLIMAX LAWN SAND

(Non Poisonous)

The double action kiln dried chemical that kills weeds and fertilizes the grass in one operation. To get the best results, "Climax Lawn Sand" should be applied evenly over the entire lawn early in the morning at the rate of 1 lb. to 4 square yards of lawn.

- 28 lb. package.....\$3.50
- 56 lb. package..... 6.00

CATTLE MANURE, Shredded

A coarse, shredded manure, dried and sterilized; useful for all general purposes.

100 lbs. \$3.00, ton \$50.00



The Desirable Lawn and Garden Top Dressing and Soil Conditioner

- is a turf dressing unlike any substitute medium.
 - is sterile, weedless, and does not have to be composted to hasten decomposition.
 - is concentrated five to one and will regain its original form when coming in contact with the moisture in the soil.
 - is cow manure on a peat moss base; dehydrated.
 - is easy to apply and easy to handle.
- Packed in 50 lb. bags—Price, \$2.75 per bag

PLANTABBS

Try these clean, odorless, easy-to-use tablets. Enjoy beautiful house plants and glorious gardens.
 25c., 50c., \$1.00.



PEAT, LEAFMOLD, Etc.

- Peat Moss (Imported).** Coarse and fine, \$3.00 per bale. Trial bale, \$1.25 each.
- Silver Sand.** For mixing with potting soil, etc. Pk. 50c., bu. \$1.50.
- Leafmold.** Best quality. Bag \$2.50.
- Moss, Live Sphagnum.** Bu. \$1.50, bag \$3.50.
- Moss, Dry Sphagnum.** Bag \$1.50. Small bale \$6.50, large bale \$10.00.
- Orchid Peat, or Fern Root.** Best selected. Hand picked. Bag \$4.00.

INDEX—Continued

Page	Page	Page	Page	Page
Portulaca.....53	Thunbergia.....60	Carbola.....103	Herbicide.....104	Rubber Aprons.....102
Potato.....19	Timothy.....27	Carnation Supports..85	Hoes.....87, 98, 100	Rubber Boots.....102
Potentilla.....53	Tobacco.....23	Castor Pomace.....105	Hose Clamps.....87	Rubber Gloves.....102
Primrose.....50, 53, 54, 72, 73	Tomato, VI, 22, 23, 24	Cattle Manure.....106	Hose Connection.....87	Salt.....106
Primula..II, 53, 54, 73	Torenia.....60, 68	Cattle Spray.....103	Hose Couplings.....87	Sand, Silver.....106
Prince Edward Isle	Trees, Deciduous...78	Celery Wrappers....86	Hose Menders...87	Sash, Hotbed.....90
Bent.....27	Evergreen.....80, 81	Chains.....85	Hose Nozzles.....87	Savage Duster.....92
Privet.....77	Fruit.....83	Charcoal.....105	Hose Reducers.....87	Saws.....90
Pteris.....63	Tritoma.....60, 73	Chrysanthemum	Hose Reel.....87	Scalecide.....104
Pumpkin.....19	Trollius.....60, 73	Manure.....105	Hose, Rubber, and	Scissors.....90
Pyrethrum.....55, 73	Tropaeolum.....60	Clay's Fertilizer...105	Cotton.....87	Scoops.....90
Radish.....19, 20	Tuberose.....67	Coal Tar.....85	Hose Washers.....88	Scrapers.....98
Ranunculus.....55, 73	Tuberous Rooted	Copper Solution...103	Hotbed Mats.....88	Scythes.....90
Rape.....28	Plants.64, 65, 66, 67	Corn Planter.....98	Hotbed Sash.....90	Scythe Snaths.....90
Raspberry, Flower-	Tunica.....IV	Cottonseed Meal...105	Humus.....105	Scythe Stones.....90
ing.....77	Turnip.....23	Cotton Wadding...85	Insecticides 103,104,105	Seed Drills.....100
Red Top.....27	Valerian.....60	Creosote, Gypsy	Knives.....88	Seed Pans.....86
Reseda.....48	Vegetable Oyster...20	Moth.....103	Labels.....88	Seed Sower.....90
Rhodanthe.....55	Vegetable Seed Sp-	Cultivator, Nor-	Lawn and Garden	Seeder.....90, 100
Rhode Island Bent	cialties.....V-VI	cross.....86	Dressing.....105	Semesan.....104
Grass.....27	Verbena.....II, 60, 68	Cultivators, 86, 96, 100	Lawn Mowers 93, 94, 95	Shears.....90
Rhododendron.....82	Veronica.....IV, 60, 73	Cutters.....88	Lawn Sand.....106	Sheep Manure....106
Rhubarb.....20, 24	Vetches.....28	Cyanogas.....103	Leaf Rack.....85, 91	Shovels.....90
Ricinus.....55, 68	Viburnum.....77	Derrisol.....103	Leafmold.....106	Sickle.....87
Rock Garden Plants,	Vinca.....60, 68, 73	Dibbles.....86	Lemon Oil.....103	Silkalene.....90
Hardy.....IV	Vines, Flowering...79	Driconure.....106	Lime, Agricultural..105	Slug Shot.....104
Romneya.....55	Viola.....60, 61, 73	Dusters.....92	Lime, Sulphur Solu-	Snarol.....106
Roots and Plants...24	Virginian Stock...61	Edging Knife.....86	tion.....103	Soap, Fish, Oil....104
Roses.....74, 75	Viscaria.....61	Electric Tape.....86	Manure Forks...86, 87	Soap Sprayer.....92
Rudbeckia.....55, 73	Wallflower...37, 61, 68	Evergreen.....104	Manure Hooks....88	Soap Spray "Imp."104
Rutabaga.....23	Watermelon.....14	Farm Garden and	Mats.....88	Soap, Sulpho To-
Rye.....25	Weigela.....77	Lawn Requisites..85	Mattocks.....88	bacco.....104
Rye Grass.....27	Wheat.....25	-102	Melon Nets.....88	Sod Lifter.....90
Saintpaulia.....55	Whitlavia.....61	Fern Root.....106	Mole Traps.....88	Soot.....106
Salpiglossis.....55, 68	Wood Meadow Grass27	Ferrules.....86	Moss, Sphagnum...106	Spades.....90
Salsify.....20	Xeranthemum.....61	Fertilizers.....105, 106	Mower, Deering, etc.99	Spading Forks...87
Salvia.....55, 56, 68	Yucca.....61, 82	Fertilizer Sower...98	Murrah Meal.....105	Sprayers.....89, 92
Sanvitalia.....56	Zinnia.....III, 61, 68	Fertilizer	Muriate of Potash..105	Spray Pumps..89, 102
Saponaria.....56		Distributor.....98	Nico-Fume Paper	Sprinklers..88, 89, 101
Satin Flower.....44		Flower Pot Hangers.86	and Liquid.....103	Stake Fasteners,
Saxifraga.....IV		Flower Pots, Sau-	Nicotine Pyrox...103	Eureka.....90
Scabiosa.....56		cers, etc.....86	Nitrate of Soda...105	Stakes.....90-91
Schizanthus.....56		Forks.....86, 87	Oilers.....88	Sticks, Match.....91
Schizopetalum....56		Fungicides 103, 104, 105	Oil, Harvester....88	Stockbridge Ferti-
Sedum.....IV, 56, 73		Fungine.....103	Oil Skin Clothing 102	lizers.....105
Seeds for Wild Gar-		Fungitrogen.....103	Orchid Peat.....106	Stone Boats.....99
dens.....62		Garden Grower, Nor-	Pails.....88	Styptic.....91
Sensitive Plant....48		cross.....100	Pans, Bulb and Seed 86	Sulphate of Am-
Shamrock.....56		Garden Lines.....87	Paper.....88	monia.....106
Shrubs.....76, 77		Garden Reels.....87	Paris Green.....103	Sulphocide.....104
Sidalcea.....56		Garden Requisites..85-	Peat.....106	Sulphur Flour....104
Silene.....IV, 56		102	Pencils, Indelible..88	Superphosphate, A.
Small Fruits.....84		Gardener's Gloves	Picks, Contractors..88	A.....105
Smilax.....57		87, 102	Plantabbs.....106	Sylpho-Nathol....104
Smokebush.....77		Gypsy Moth Creo-	Plant Protecting	Tamper.....91
Snapdragon, Alpine.46		sote.....103	Cloth.....88	Tape Lines.....91
Snowberry.....77		Glass Cutters.....87	Plant Protectors....88	Tarred Yarn.....91
Soja Beans.....28		Glazing Machines..87	Plant Spray.....104	Tedder, Hay.....99
Solanum.....57		Glazier's Points...87	Plant Sprinklers...88	Thermometers....91
Specialties in Flower		Gloves, Garden.87, 102	Plant, Tubs.....88	Thrip Juice.....101
Seed.....I-IV		Goggles.....102	Plows.....97	Tin Foil.....91
Specialties in Vege-		Grafting Knife.....87	Pomo Green.....103	Tobacco Dust and
table Seed.....V-VI		Grafting Wax.....87	Post Hole Digger...88	Stems.....104
Spinach.....VI, 20		Grape Dust.....103	Potato Hoe.....98	To-Na-Cide.....106
Spiraea.....73, 77		Grass Catchers....95	Potato Hooks.....88	Tree Scraper.....91
Squash.....VI, 21		Grass Hooks.....87	Pruners, Tree.....88	Trellises.....91
Statice.....57, 73		Grey's 9-6-6 Plant	Pumps, Auto Spray.89	Trowels.....91
Stephanandra.....77		Food.....105	Pulverized Poultry	Trucks.....91
Stevia.....57		Grindstones.....87	Manure.....105	Tubs, Plant.....88
Stocks.....57		Grindstone Fixtures.87	Pumps, Pomona....102	Twine.....91
Stokesia.....57, 73		Hammers.....87	Putty Bulb.....90	Tying Materials...91
Streptocarpus.....57		Hand Cart, Box, etc.91	Pyrox.....103	Vermine.....104
Sudan Grass.....28		Handles.....87	Raffia.....90	Volck.....104
Sunflower...28, 44, 71		Harrows.....96	Rakes.....90, 99	Watering Pots...92
Swainsona.....57		Hatchets.....87	Rake, Hay.....90, 99	Wedges.....92
Sweet Clover.....57		Hay Forks.....86	Red Arrow Inspect	Weeders.....91, 92, 98
Sweet Peas..II, 58, 59		Hay Tedders.....99	Spray.....104	Weed Killer.....104
Sweet Vernal.....27		Hay Rakes, Deer-	Richard's X L All..103	Wheelbarrows.....85
Sweet William.....59, 60, 70		ing, etc.....99	Rollers.....101	Wheel Hoe.....100
Syringa.....77		Hedge Shears.....90	Rope.....90	Whiffletrees.....92
Tarragon Plants.....24				Wire.....92
				Wrenches.....92

SUNDRIES

A. A. Superphosphate	105
Acme.....	103
Adco.....	106
Antrol.....	106
Aphine.....	103
Arsenate of Lead....103	
Ashes.....	105
Asparagus Buncher..85	
Asparagus Knife...85	
Axes.....	85
Bamboo Poles.....85	
Bands, Rubber.....85	
Barrow.....	85
Barrow Leaf Rack...85	
Bars, Crow.....85	
Baskets, Miscella-	
neous.....	85
Basswood Poles....85	
Bellows.....	85
Bill Hooks.....	85
Black Leaf 40.....103	
Blood Tankage.....105	
Bon Arbor.....	105
Bone, Fine Ground,	
etc.....	105
Bordeaux Mixture..103	
Bowker's Fertilizer.105	
Boxes, Flower.....85	
Boxes, Shipping....85	
Brooms.....	85
Brushes.....	85
Bulb Pans.....	86
Bull Rings.....	85
Burlap.....	85
Burning Brands....85	
Bush Hooks.....	85
Bye, Bye, Blackbird 103	
Calcium Chloride...105	

PARCEL POST RATES—SEE 2nd COVER PAGE



ALWAYS LOOK ON THE LABEL for the GERM COUNT, yearly Expiration DATE and the PRICE

INOCULATE your legumes

Alfalfa, clovers, soy beans, cow peas, vetch, peas, lespedeza, beans
with



COSTS YOU FAR LESS

When you buy NITRAGIN you buy billions of fresh Legume Germs—not just a package of inoculation. You cannot see the Germs, but NITRAGIN is the only inoculant sold that actually guarantees the number packed in each container.

PLAY SAFE—USE NITRAGIN

The Germ Count and the Expiration Date on the label of every can gives you double protection. NITRAGIN is always reliable. Buying a cheap Inoculant by price on package only is a gamble. Like cheap seed, cheap inoculants are by far the most expensive.

NITRAGIN IS EASY TO APPLY WITH OR WITHOUT WATER

NITRAGIN is a granular moist soil-like culture packed in tins. Directions on every can. If mixed well can be applied to seed without water and good inoculation will result. However any inoculation will give more uniform results when water is used as recommended by agricultural authorities.

Remember NITRAGIN can do anything claimed by other inoculants—and do it BETTER and CHEAPER.

NITRAGIN INOCULATION PRICES

When ordering, always specify kind of seed.

Size	Retail
½ bu.	\$.50
1 bu.90
5 bu.	4.00

Size	Retail
½ bu.	\$.40
1 bu.60
1-2/3 bu.90
5 bu.	2.50

*"100 lb. size." Packed only for Vetch and Aust. Pea.

Size	Retail
1 bu.	\$.40
2 bu.70
5 bu.	1.50
10 bu.	2.50

Garden NITRAGIN for Peas, Beans, Sweet Peas

Inoculates from 1 oz. to 8 lbs. seed, Price 25c

NITRAGIN HAS SERVED THE AMERICAN FARMER SINCE 1898

Practical Books for the Home Gardener

- GARDEN GUIDE. Within its 384 pages the inquiring amateur will find information and instruction on every possible subject connected with the flower, fruit or vegetable garden. Paper, \$1.10; cloth, \$1.65.
- FLOWERS OF THE WILD. Frank C. Pellett. Cloth, \$2.15.
- THE BOOK OF ANNUALS. A. C. Hottes. Cloth, \$1.65.
- THE BOOK OF PERENNIALS. A. C. Hottes. Cloth, \$1.65.
- MODERN DAHLIA CULTURE. W. H. Waite. Cloth, \$1.65.
- PRACTICAL LANDSCAPE GARDENING. Robt. B. Cridland. Cloth, \$2.65.
- THE WOMAN'S FLOWER GARDEN. Jane Leslie Kift. Cloth, \$1.35.
- MILADY'S HOUSE PLANTS. F. E. Palmer. Paper, \$1.10; cloth, \$1.35.
- ALL ABOUT FLOWERING BULBS. T. A. Weston. Cloth, \$2.15.
- THE BOOK OF SHRUBS. A. C. Hottes. Cloth, \$3.15.
- WAYSIDE MARKETING. Schuyler Arnold. Cloth, \$1.65.

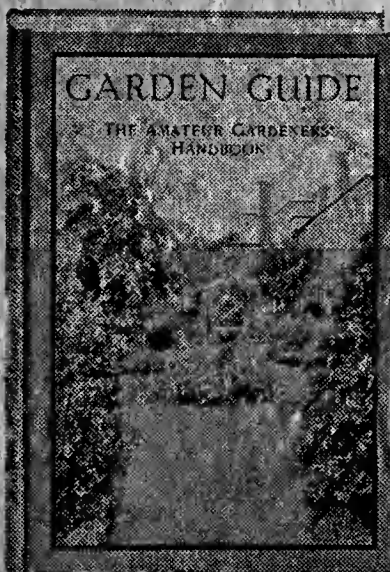

- PRACTICAL VEGETABLE CULTURE. Prof. A. E. Wilkinson. Cloth, \$2.15.
- ROOF GARDENING. Ida Mellen. Cloth, \$1.35.
- WATER GARDENS AND GOLDFISH. Sawyer and Perkins. Cloth, \$1.65.
- CITY AND SUBURBAN GARDENING. Chesla C. Sherlock. Cloth, \$2.15.
- GARDENING UNDER GLASS. F. F. Rockwell. Cloth, \$2.65.
- FOUNDATION PLANTING. L. H. Johnson. Cloth, \$3.65.
- FERTILIZERS FOR GREENHOUSE AND GARDEN CROPS. Laurie and Edmond. Cloth, \$2.15.
- BIRDS OF THE WILD. Frank C. Pellett. Cloth, \$1.90.
- 1001 GARDEN QUESTIONS ANSWERED. A. C. Hottes. Paper, \$1.65; cloth, \$2.15.
- THE PRINCIPLES OF FLOWER ARRANGEMENT. E. A. White. Cloth, \$3.15.
- PRACTICAL PLANT PROPAGATION. A. C. Hottes. Cloth, \$2.15.
- ROCK GARDEN PRIMER. Archie Thornton. Cloth, \$2.15.

ORNAMENTAL DWARF FRUIT TREES. E. Abjornson. Cloth, \$1.65.

Written by experts, the contents of these books are dependable, covering the subjects lucidly, thoroughly and yet concisely. Splendidly illustrated, well printed and well bound. All prices postpaid.



THOS. J. GREY CO.
16 South Market Street
Boston, Mass.